

COMPLETE CATALOGUE

TOP QUALITY AND BIGGEST RANGE

Protektor
since 1903

INTERNAL PLASTERING | WET ROOMS | EXTERNAL RENDERING | THERMAL INSULATION
INTERNAL CONSTRUCTION | DRY LINING / LIGHTWEIGHT STEEL CONSTRUCTION
CURTAIN WALL | VENTILATION PROFILES | ROOF DRAINAGE | CONCRETE / SCREED

www.protektor.com



PROTEKTOR ACADEMY

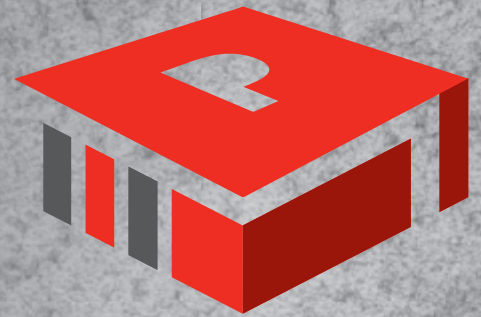

TOGETHER TO THE PERFECT PROFILE -
THE PRACTICAL EXCHANGE WITH PROTEKTOR

- ▶ COMPETENCE · EXPERTISE · KNOW-HOW
- ▶ WEBINARS ONLINE
- ▶ WORKSHOPS OFFLINE

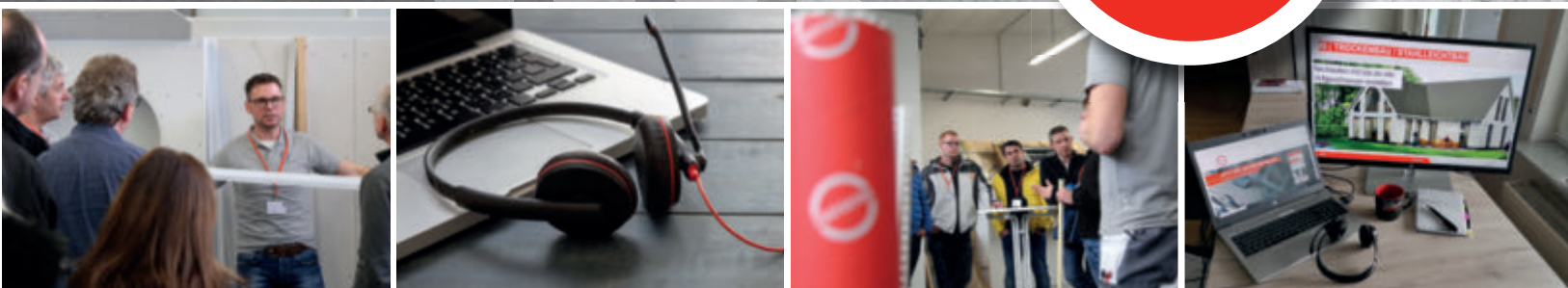

REGISTER NOW AT:

www.protektor.de/akademie



SCAN NOW
AND REGISTER »



CONTENT

CONTENT

OVERVIEW	
Protektor - Profiles for modern building	4
OVERVIEW ICONS	
Overview icons	13
PROFILE SELECTION	
Table - Profile selection by mortar type	14
INTERNAL PLASTERING	
Corner profiles	16
Flatness guides	24
Shadow joint profiles	26
Plaster stop profiles	27
Base profiles	30
Joint profiles	31
Images bar	33
Reinforcing mesh Internal plastering	34
Plaster bases	35
EXTERNAL RENDERING	
Corner profiles	38
Plaster/render stops	42
Base profiles	43
Connecting profiles	44
Joint profiles	48
Design profiles	49
Wired corner beads	50
Reinforcing mesh External rendering	53
CORROSION PROTECTION	
Edge profiles Corrosion protection	55
Plaster gauges Corrosion protection	59
Plaster Stops Corrosion protection	60
Base profiles Corrosion protection	62
PVC profiles	64
SOFFIT CONNECTION PROFILES	
Tables - Selection of plastering strips/plaster sealing strips...	67
Soffit connection profiles	69
THERMAL INSULATION	
Corner profiles	77
Plaster/render stops	80
Drip edge profiles	81
Connecting profiles	82
Base profiles	83
Joint profiles	89
Edging profiles	92
Profiles for mechanical fixing	93
Reinforcement mesh	94
Profiles for insulating plaster	95
Reinforcing mesh Thermal insulation	96
INTERNAL CONSTRUCTION	
Corner profiles	100
Plaster stop profiles	107
Shadow joint profiles	112
Connecting profiles	118
Design profiles	120
Joint profiles	121
Edging profiles	123
Images bar	125
Composite profiles	127

Joint cover strips	131
Profile adhesive	132
Tools	134
CONSTRUCTION CHEMISTRY	
Construction chemistry	138
DRY LINING	
Standard ceilings and walls	140
Special products	150
Preformed parts	158
Standard accessoires	161
Formable profiles flexibilo	172
Joint tapes	176
Fixing accessories	178
Anti corrosion defendo	181
Sound Insulation silencio	192
Lightweight steel construction edificio	196
Supports and door systems passagio	206
LED-Lightning Design lumino	214
Tools	220
CURTAIN WALL	
Product information	222
Corner profiles	225
Connecting- and stop profiles	238
Joint profiles	247
Joint tapes	256
Angle profiles	260
Omega Profile	263
VENTILATION PROFILES	
Product information Ventilation profiles	265
Protektor ventilation system (PLS)	269
Ventilation profiles	272
Eaves ventilation	288
Special profiles	291
ROOF DRAINAGE	
Product Information	292
Halfround gutters	293
Box gutters	306
Gutter accessories	315
Gutter pipes and accessories	316
Carport gutters	335
Leaf traps	337
Roof plates	339
Gutter sets	342
Tools	354
CONCRETE/SCREED	
Product information	355
Joint profiles	358
Heat conduction plates	362
Stair corner profiles	363
Gravel trap strips	365
PRODUCT INFORMATION	
Product information plaster / WDVS	368
Safety through rounded edges	370
Product information dry construction	371





— MARKET LEADER IN EUROPE



Over 3.000 products for modern building

Development and production: Made in Germany

PROTEKTOR | THE BEST SOLUTION

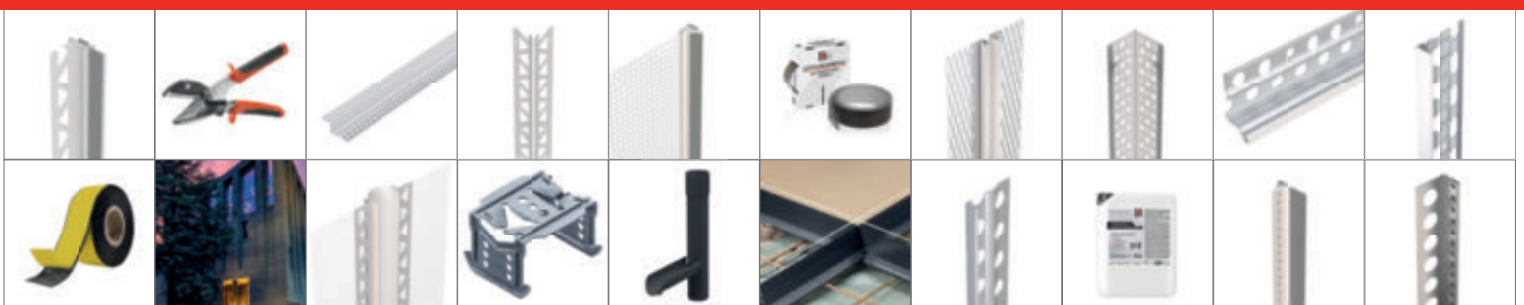

INDEX

INCREASING BY ARTICLE NUMBER

10...									
1004	18	1114	33	1265	95	1479	135	2072	22
1005	20	1116	358	1266	95	1482	138	2073	22
1007	19	1118	125	1283	95	1492	94	21...	
1007A	20	1120	123	1284	95	1493	94	2130	85
1007Z	19	1121	123	1285	95	1494	94	2132	85
1012Z	40	1122	123	1286	95	14911	34	2134	85
1013	41	1123	123	1295	95	14912	35	2135	60
1014	41	1131	107	12111	28	14913	35	2136	60
1015	18	1132	107	12164	27	14914	36	2151	89
1017	18	1133	109	13...		14915	36	2152	89
1018	18	1134	109	1301	26	14916	94	2154	81
1020	39	1135	107	1304	114	14917	53	2178	60
1022Z	21	1136	109	1306	26	14918	53	2180	60
1023	38	1138	108	1311	112	14919	53	2182	60
1024Z	40	1156	50	1312	26	14920	96	2184	62
1026	18	1159	52	1313	114	14921	96	22...	
1027	16	1161	52	1314	112	14922	96	2205	59
1028	41	11055	25	1315	114	14923	97	2206	59
1030	100	11066	24	1316	112	14924	97	2208	59
1031	101	11311	107	1319	113	14925	97	2209	56
1033	102	11321	108	1321	29	14926	97	2212	58
1039Z	41	11511	50	1325	115	14927	98	2215	55
1041	21	11521	51	1328	115	14940	98	2218	57
1043Z	38	11531	51	1371	113	14941	98	2225	62
1044Z	21	11541	50	1373	113	14942	98	2229	62
1045Z	38	11551	51	1374	115	14943	98	2230	63
1046	39	11571	50	1375	115	14950	131	2231	60
1051	19	11581	52	1377	115	14951	131	2232	60
1058	17	11601	51	13131	112	14952	131	2233	61
1061	39	12...		13141	112	14953	131	2236	89
1062	39	1201Z	32	13191	113	14954	131	2241	118
1063	95	1206Z	31	14...		14955	131	2251	56
1064	95	1210	28	1422	133	14956	131	2263	118
1065	95	1211	28	1423	132	14957	131	2274	55
1066	95	1212A	29	1424	133	14960	34	2293	46
1078	100	1214	30	1425	133	14961	34	2295	46
1080	39	1216	27	1426	132	14962	34	2297	45
1084	17	1216A	27	1427	133	14963	34	2299	45
1085Z	38	1218	29	1428	132	14964	34	27...	
1086	39	1219	30	1429	132	15...		2765	45
1087	16	1220	29	1430	132	1500	136	2768	44
1088	17	1222	42	1440	138	17...		30...	
1089	24	1223	42	1441	138	1750	113	30351	90
1092	78	1224	42	1442	138	1751	114	30352	90
1096	79	1225	43/48	1444	138	1753	114	30361	90
1098	94	1226	48	1445	138	1765	45	30362	90
10077	20	1227	43	1446	139	17708	35	32...	
10122	40	1229	43/48	1447	139	17709	35	3226	121
10881	17	1230	29	1448	138	17710	35	33...	
10882	22	1231	28	1449	138	18...		3310	257
10883	108	1233	123	1452	136/221	1821	38	3311	257
11...		1234	107	1453	136	1824	38	3312	257
1104	25	1235	28	1468	135	20...		3313	257
1105	25	1236	27	1469	135	2000	364	3314	257
1106	24	1240	48	1472	134	2001	364	3315	257
1108	24	1241	42	1473	134	2026	22	3316	257
1110	33	1242	42	1474	134	2027	23	3317	257
1113	33	1263	95	1477	134	2041	23	3322	259
		1264	95	1478	135	2066	23	3325	259

INDEX

INCREASING BY ARTICLE NUMBER

3326	259	3663	289	37103	69	37523	77	3820	243
3327	258	3674	229	37104	69	37524	77	3830	282
3331	258	3677	278	37111	69	37525	77	3832	282
3332	258	3678	278	37112	70	37526	77	3833	282
3333	258	3679	278	37127	82	37527	44	3834	283
3334	258	3681	278	37128	82	37530	86	3836	283
3335	259	3682	278	37129	72	37531	91	3840	105
3336	259	3683	279	37154	92	37532	90	3841	286
35...		3685	278	37155	92	37537	87	3842	286
3501	232	3686	278	37169	105	37538	87	3843	286
3502	242	3687	290	37171	102	37539	87	3844	286
3503	233	3688	290	37172	105	37540	90	3845	287
3504	232	3691	241	37207	82	37606	69	3846	286
3505	236	37...		37214	47	37609	70	3847	286
3506	229	3711	71	37300	85	37651	103	3848	286
3518	262	3712	72	37301	85	37706	69	38406	64
3519	261	3726	70	37302	85	37709	70	38408	64
3520	261	3735	123	37317	128	37716	72	38410	64
3524	261	3738	123	37318	129	37719	71	38414	64
3525	262	3741	123	37320	127	37720	71	38510	65
3527	242	3744	124	37321	130	37724	120	38514	65
3528	261	3747	123	37322	127	37729	70	38610	71
3529	241	3749	82	37323	127	37734	120	38613	71
3534	251	3750	121	37324	127	37744	120	38614	71
3535	251	3751	103	37325	127	37806	73	38807	75
3536	252	3752	79	37326	130	37809	73	38810	74
3537	252	3753	31	37327	129	37814	116	38814	74
3540	262	3754	31	37328	130	37822	116	39...	
3546	255	3755	122	37329	128	37824	116	3906	358
3547	255	3756	84	37331	128	37825	116	3908	358
3548	255	3757	85	37333	129	37827	116	3914	358
3554	252	3758	121	37334	130	37832	118	3915	359
3555	232	3759	93	37339	129	37834	116	3916	360
3557	254	3760	93	37340	128	37842	117	3917	359
3558	255	3761	93	37361	124	37844	117	3923	360
3560	245	3762	152	37362	124	37848	119	3929	359
3561	245	3763	105	37400	86	37862	110	3940	360
3562	245	3765	153	37401	86	37863	119	39828	75
3563	241	3766	118	37402	86	37864	111	43...	
3569	228	3767	106	37404	86	37865	111	4364	201
3575	233	3768	110	37406	64	37906	73	44...	
3578	261	3769	111	37408	64	37909	74	4410	199
3588	243	3770	103	37410	64	37914	80	4415	199
3589	243	3776	104	37414	64	37916	72	4419	198
3590	232	3778	104	37420	65	37921	65	4420	199
36...		3780	104	37422	65	37922	65	4427	199
3609	242	3784	118	37424	65	37923	65	44772	199
3610	275	3785	110	37428	47	37924	65	45...	
3611	275	3787	124	37429	47	37925	65	4510	199
3612	274	3788	117	37430	65	37929	74	4515	199
3613	275	3789	117	37432	65	37941	81	4519	198
3614	274	3790	103	37434	65	37942	81	4520	199
3617	275	3791	80	37500	86	37945	81	4525	198
3618	289	3793	80	37501	86	37946	47	4529	198
3623	228	3794	81	37503	87	37964	88	4530	199
3624	231	3796	80	37507	121	37968	78	4535	210
3655	153	3797	78	37509	121	37969	78	4536	210
3658	241	3799	78	37520	88	37976	79	4537	210
3662	289	37098	80	37521	77	38...		4538	210

INDEX

INCREASING BY ARTICLE NUMBER

4540	201	5127	197	5450	151	58111	189	59230	185
4541	201	5128	142	55...		58112	189	59233	185
4542	201	5129	147	5502	200	58113	189	59234	185
4543	201	5130	147	5503	200	58114	189	60...	
4544	201	5131	148	5512	149	58115	189	6004	166
4548	202	5132	148	5513	149	58116	189	6008	165
4550	201	5138	199	5514	149	58117	189	6009	165
4551	201	5140	148	5515	149	58118	189	6012	169
4552	202	5141	145	5516	149	58119	189	6013	169
4553	202	5143	152	5547	169	58121	187	6014	169
4554	202	5149	149	5549	173	58122	182	6015	168
4558	202	5150	149	5550	173	58123	189	6017	168
4591	204	5151	149	5551	173	58124	189	6018	169
4593	205	5152	149	5552	173	58125	189	6019	167
4597	202	5156	152	5553	174	58126	189	6020	167
4599	205	5161	154/260	5555	174	58128	187	6021	167
46...		5162	154/260	5556	174	58129	188	6022	167
4610	200	5165	155/260	5570	154	58130	184	6023	167
4611	200	5167	143	5575	154	58148	185	6024	167
4615	200	5168	143	5580	154	58150	191	6025	167
4616	200	5170	151	56...		58159	187	6026	167
47...		5177	155/260	56300	195	58168	182	6027	167
4705	197	5178	151	56310	194	58203	191	6028	167
4710	197	5179	143	56311	194	58205	190	6029	167
4715	197	5186	154/260	56321	195	58206	190	6031	167
48...		5189	155/260	56322	195	58215	190	6032	168
4810	197	5194	155	56323	195	58216	190	6034	165
4815	197	5198	200	56324	195	58220	191	6038	165
4850	210	52...		56325	195	58221	191	6040	166
4851	210	5211	144	56326	195	58227	190	6041	166
4852	210	5215	144	56342	195	58236	190	6042	166
4859	210	5216	145	56344	195	58239	191	6043	166
4862	210	5224	145	56359	194	58304	186	6044	166
4863	210	5230	146	56367	194	58310	187	6045	166
4864	210	5233	146	56369	194	58317	188	6046	166
49...		5234	146	56393	194	59...		6048	166
4914	198	5236	152	57...		59011	183	6050	166
4918	198	5237	152	57100	160	59014	182	6051	166
4923	198	5238	152	57101	160	59015	183	6052	166
4929	198	5239	152	57102	160	59016	183	6053	166
50...		5241	173	57230	159	59019	185	6054	166
5007	194	5244	142	57234	159	59020	186	6055	166
50198	143	5247	146	57235	159	59021	186	6056	166
50414	362	5248	146	57236	159	59022	186	6062	166
50416	362	5261	209	57237	159	59023	186	6063	166
50914	362	5262	209	57238	160	59024	184	6077	163
50916	362	5263	209	57260	155	59030	184	6078	162
51...		5272	174	57261	155	59033	184	6079	163
5100	193	5273	174	57265	156	59034	184	6090	162
5101	142	5274	174	58...		59041	184	6092	164
5104	193	53...		58102	182	59047	184	6096	164
5111	142	5313	193	58103	186	59048	184	60211	167
5112	152	53000	177	58104	186	59182	190	60212	167
5114	143	53110	177	58105	189	59183	190	60213	167
5116	141	53111	177	58106	188	59185	189	60214	167
5117	141	53168	151	58107	188	59198	205	60215	167
5118	141	53244	151	58108	187	59211	185	60216	167
5120	141	53400	177	58109	189	59215	185	60218	167
5121	142	54...		58110	189	59216	185	60219	167

INDEX

INCREASING BY ARTICLE NUMBER

60220	167	63...		6610	208	81008	295	81419	322
60225	167	6300	165	6615	208	81010	320	81500	301
60230	167	6301	165	6616	208	81011	294	81502	303
61...		6302	165	6617	208	81012	294	81508	328
6100	162	64...		6618	208	81015	320	81511	302
6102	162	6400	212	6619	208	81020	293	81512	302
6105	162	6401	212	6620	208	81025	329	81515	327
6110	164	6402	212	6625	208	81026	322	81516	327
6111	164	6403	212	6626	208	81027	322	81520	301
6116	163	6427	221	6627	208	81029	322	81527	329
6117	165	6429	221	6628	208	81034	321	81529	329
6118	165	6430	221	6629	208	81039	295	81532	314
6126	193	6431	221	6630	208	81100	306	81534	328
6127	193	6432	221	6645	209	81101	306	81710	323
6128	164	6490	204	6646	209	81102	308	81711	325
6129	195	6491	205	6647	209	81103	308	81712	330
6141	171	65...		6655	209	81104	308	81713	330
6144	153	6500	215	6656	209	81108	317	81714	333
6146	153	6501	215	6657	209	81111	307	81715	308
6148	153	6518	217	6665	209	81112	308	81800	304
6156	170	6519	218	6666	209	81113	306	81801	323
6157	164	6522	215	6667	209	81114	306	81802	305
6158	170	6523	216	67...		81115	316	81805	329
6159	163	6524	215	6727	155	81117	307	81806	330
6160	194	6525	218	6732	155	81118	317	81807	332
6161	164	6526	218	6733	155	81119	307	81808	332
6162	171	6531	219	6735	155	81122	306	81811	305
6166	163	6533	216	6736	155	81123	318	81812	305
6167	163	6534	217	6751	170	81126	318	81813	304
6169	163	6538	218	6752	170	81128	318	81814	304
6172	201	6539	218	6753	170	81129	318	81815	331
6182	170	6541	218	6754	170	81132	307	81820	304
6183	170	6542	216	6755	170	81134	316	81827	332
6184	201	6543	216	6756	170	81139	309	81830	325
6185	170	6546	217	6765	155	81141	308	81834	331
6186	202	6547	217	6766	155	81200	297	81840	329
6187	177	6549	153	6767	155	81202	299	81845	323
6188	177	6558	203	6768	155	81208	321	81880	319
6189	177	6578	153	6769	155	81209	299	81890	319
6190	170	6580	204	74...		81210	324	81900	316
6194	177	6582	204	7426	21	81211	298	81901	316
6195	177	6585	204	7476	56	81212	298	81902	320
6196	177	6586	203	7478	58	81215	324	81904	324
6197	177	6587	203	7483	58	81220	297	81906	327
6199	168	6588	203	75...		81227	325	81908	331
62...		6589	203	7501	31	81229	325	81910	328
6201	168	6590	203	7503	31	81234	324	81950	317
6202	179	6591	208	7521	32	81239	299	81951	317
6203	179	6593	208	7523	32	81250	315/354	82...	
6216	179	6595	208	7541	31	81255	315/354	82000	293
6228	179	6598	209	7571	32	81314	328/332	82012	294
6229	179	6599	209	7573	32	81315	317/321	82013	293
6234	204	66...		80...		81316	328/332	82014	293
6236	180	6602	209	8058	106	81317	317/321	82015	320
6237	180	6605	208	8060	106	81318	317/321	82016	320
6239	180	6606	208	8068	122	81319	328/332	82017	294
6242	179	6607	208	81...		81321	340	82018	321
6248	180	6608	208	81000	293	81341	339	82028	322
6260	180	6609	208	81002	295	81418	318	82032	311

INDEX

INCREASING BY ARTICLE NUMBER

82115	316	83116	324	83601	293	84202	299	85...	
82118	317	83117	302	83602	295	84209	299	85415	323
82200	297	83118	325	83608	295	84211	298	85416	326/330
82212	299	83120	301	83610	320	84212	298	85516	338
82213	297	83129	325	83612	294	84220	297	85517	338
82214	297	83132	336	83615	320	84239	299	85518	295/300/337
82215	324	83134	324	83616	320	84308	318	85519	303/305/337
82216	324	83135	325	83617	294	84313	297	85520	296/300/337
82217	298	83150	330	83618	321	84314	297	85558	296/300/303/
82218	325	83213	297	83620	293	84318	321	85559	296/300/303/
82222	315/354	83214	297	83626	322	84400	334/352	85560	296/300/303/
82315	320	83215	324	83629	322	84402	320	85562	296/300/337
82317	298	83218	325	83632	311/335	84410	320	85684	347
82415	324	83219	330	83634	321	84415	320	85685	347
82417	298	83220	323	83636	323	84416	320	85686	347
82500	301	83221	330	83639	295	84417	298	85687	348
82512	302	83227	298	83640	323	84418	321	85688	348
82513	301	83308	328	83650	329	84426	322	85689	348
82514	301	83313	301	83708	322	84428	322	85690	348
82515	327	83314	301	83713	293	84432	311	85691	348
82516	327	83315	327	83714	293	84434	321	85692	348
82517	302	83321	340	83715	320	84439	295	85693	348
82518	328	83341	339	83716	320	84440	323	85694	348
82600	335	83400	310	83728	322	84441	323	85695	348
82603	335	83401	310	83816	324	84500	293	85696	348
82613	335	83402	312	83817	298	84501	293	85697	348
82615	327	83411	311	83916	327	84502	295	85698	348
82618	321	83412	311	84...		84503	295	85699	345
82620	335	83413	310	84000	334/352	84508	322	85700	345
82812	305	83414	310	84015	316	84511	294	85701	345
82816	331	83415	316	84017	298	84512	294	85702	345
82817	304	83416	316	84022	306	84513	293	85703	345
82818	331	83419	311	84029	318	84514	293	85704	345
82918	332	83422	310	84055	319	84517	294	85705	345
83...		83439	312	84100	306	84520	293	85706	345
83000	297	83500	306	84101	306	84600	301	85707	345
83001	297	83501	306	84102	308	84601	301	85708	345
83002	299	83502	308	84108	317	84602	303	85709	345
83009	299	83508	318	84110	316	84606	330	85710	345
83011	298	83511	307	84111	307	84608	328	85711	345
83012	298	83512	308	84112	308	84611	302	85712	345
83015	327	83513	306	84113	306	84612	302	85831	343
83016	327	83514	306	84114	306	84615	327	85832	343
83017	298	83515	316	84115	316	84616	327	85834	343
83018	328	83516	316	84116	316	84618	328	85837	346
83020	297	83517	307	84117	307	84620	301	85839	346
83024	327	83518	317	84118	317	84629	329	85846	349
83027	329	83519	307	84119	307	84634	328	85847	349
83029	329	83522	306	84123	318	84640	329	85848	349
83034	328	83523	318	84125	320	84706	327	85849	349
83039	299	83526	318	84126	318	84713	301	85850	349
83055	319	83528	318	84128	318	84714	301	85851	349
83100	301	83529	318	84132	307	84715	327	85852	351
83101	301	83532	307	84134	316	84716	327	85853	350
83102	303	83534	316	84139	309	84717	302	85854	351
83110	324	83539	309	84141	308	84720	330	85855	350
83111	302	83541	308	84180	319	84721	323	85856	346
83112	302	83580	319	84200	297	84815	320	85859	343
83115	324	83600	293	84201	297	84915	316	85864	343

INDEX

INCREASING BY ARTICLE NUMBER

85866	352	86112	294	86500	306	88568	307	9092	250
85869	344	86113	293	86501	306	88569	316	9095	276
85873	346	86114	293	86502	308	88570	320	9096	276
85889	345	86115	320	86504	308	88571	322	90527	44
85890	345	86117	294	86511	307	88572	316	90535	44
85891	345	86118	321	86512	308	88573	320	90602	83
85892	345	86120	293	86513	306	88574	320	90603	83
85893	345	86124	320	86514	306	88575	320	90604	83
85894	345	86126	322	86515	316	88600	293	90605	83
85901	343	86129	322	86516	316	88601	293	90606	83
85902	343	86134	321	86517	307	88603	293	90607	83
85903	346	86135	323	86518	317	88604	293	90608	83
85904	343	86139	295	86519	307	88605	293	90609	83
85905	346	86155	319	86522	306	88606	295	90610	83
85906	343	86200	297	86523	318	88607	294	90616	83
85907	343	86201	297	86526	318	88608	295	90804	83
85909	343	86202	299	86529	318	88609	321	90805	83
85910	343	86208	299	86532	307	88610	321	90806	83
85911	343	86211	298	86534	316	88639	295	90808	83
85912	346	86212	298	86535	319	90...		90810	83
85920	344	86213	297	86539	309	9002	109	90811	83
85930	346	86214	297	86541	308	9003	59	90812	83
85943	343	86215	316	86600	334/352	9005	59	90814	83
85944	344	86216	327	86601	334/352	9007	20	90816	83
85948	346	86217	298	86602	334/352	9008	59	90818	83
85954	343	86218	317	86603	334/352	9011	81	90820	83
85959	346	86220	297	86608	322	9027	254	90881	16
85960	346	86228	318	86616	320	9040	276	91...	
85966	346	86232	311	86617	298	9041	276	9100	55
85970	343	86239	299	86621	340	9042	248	9104	55
85972	343	86300	301	86641	339	9043	272	9110	61
85974	343	86301	301	86708	321	9044	272	9111	61
85976	343	86302	303	86715	320	9046	273	9112	57
85978	343	86308	328	86716	320	9047	250	9113	58
85980	344	86310	330	86728	322	9048	250	9114	93
85984	350	86311	302	86816	316	9049	250	9115	93
85985	350	86312	302	86915	327	9053	248	9116	93
85986	350	86313	301	86916	327	9054	248	9121	85
85987	350	86314	301	86935	330	9056	289	9122	85
85988	350	86315	327	88...		9059	289	9123	60
85989	350	86317	302	88000	310	9061	250	9124	85
86...		86318	328	88001	310	9062	250	9125	62
86000	313	86320	301	88002	312	9063	290	9130	366
86001	313	86329	329	88008	312	9071	272	9134	57
86002	314	86334	328	88011	311	9072	272	9135	28
86011	314	86335	329	88012	311	9073	273	9136	27
86012	314	86408	318	88013	310	9074	16	9139	366
86013	313	86410	339	88014	310	9075	78	9141	84
86014	313	86412	339	88019	311	9078	101	9172	102
86016	320	86414	339	88022	310	9079	101	9179	102
86017	314	86416	339	88039	312	9080	226	9181	89
86019	313	86418	340	88560	320	9081	245	9182	89
86022	313	86420	340	88561	320	9083	243/271	91010	84
86100	293	86422	340	88562	321	9085	239	91012	84
86101	293	86424	341	88563	318	9086	250	91013	84
86102	295	86426	341	88564	311	9087	251	91014	84
86108	295	86428	341	88565	316	9088	251	91015	84
86110	323	86429	341	88566	316	9089	251	91016	84
86111	294	86430	341	88567	316	9090	239	91018	84

INDEX

INCREASING BY ARTICLE NUMBER

91020	84	9345	277	95633	84
91022	84	9346	277	96...	
91051	56	9348	277	9603	280
91081	57	9349	277	9604	280
91118	125	9350	277	9605	280
92...		9361	366	9606	280
9224	80	9363	264	9607	280
9229	62	9385	290/340	9608	281
9272	110	93304	80	9609	281
9278	101	93305	80	9610	281
9293	49	93306	80	9612	281
9294	49	93308	80	9613	280
9295	49	93310	80	9615	280
9297	109	93312	80	9617	280
9298	107	93314	80	9619	281
9299	108	93316	80	9626	284
92118	125	94...		9627	284
92122	126	9402	227	9628	284
92123	126	9407	240	9629	284
92124	126	9408	240	9630	284
92125	125	9409	240	9632	285
92126	125	9421	367	9640	285
92322	88	9423	366	9641	285
92324	88	9424	366	9642	285
92326	88	9428	228	9644	285
92328	88	9430	227	9645	285
92330	88	9431	227	9646	285
92422	77/88	9432	236	9648	285
92424	77/88	9435	260	9649	285
92426	77/88	9436	260	9650	285
92428	77/88	9437	260	9695	281
92430	77/88	9438	228	9697	282
93...		9439	228	9699	282
9300	272	9440	226	97...	
9301	272	9441	226	9736	254
9302	273	9442	226	9738	254
9303	273	9443	226	97018	226
9306	273	9444	231	97043	239
9309	272	9445	231		
9311	254	9446	231		
9312	274	9447	231		
9313	274	9449	231		
9314	274	9450	239		
9320	276	9451	239		
9321	276	9460	226		
9322	276	9461	226		
9323	276	9471	271		
9324	276	9472	271		
9325	276	9484	227		
9330	272	9485	227		
9331	272	9486	236		
9332	273	9487	240		
9333	273	95...			
9334	271/273	9540	89		
9335	271/273	9571	57		
9340	277	9579	101		
9341	277	9599	108		
9342	277	95631	84		
9344	277	95632	84		

OVERVIEW OF ICONS

EXPLANATION OF ICONS



Aluminium profiles with white primer coating for lasting protection.



Galvanised steel profile with with increased zinc coating.



Stainless steel profiles.



Profiles with surface embossing for improved plaster adhesion.



Powder coating according to RAL possible against surcharge. Coating page see data sheet on the Internet. Exclusion of liability for stainless steel profiles.



Suitable for fixing in interior fittings with profile adhesive.



Plastering and plaster sealing strips that have been tested and certified by the ift. The current test reports are available for download at www.protektor.de.



Tested air, wind and driving rain tightness. The current test reports are available for download at www.protektor.de.



For damp rooms with water exposure class up to W2-I.



For damp rooms with water exposure class up to W3-I.



Filler profiles fulfil the specifications of the VOB (German Construction Contract Procedures).



Movement according to VDPM data sheet/SAF guideline Class A
 Movement according to ÖNORM B6400/ÖAP-VAR VII Class III
 The current test reports are available for download at www.protektor.de.

PROFILE SELECTION BY MORTAR TYPE



The following table gives the correct combinations of plaster profile and plaster mortar:

Mortar/plaster	Profile material for exterior use					Profile material for interior use (excluding damp areas and domestic bathrooms)				
	galvanised	alvanised with coating	galvanised with PVC edge	aluminium	stainless steel	galvanised	alvanised with coating	galvanised with PVC edge	aluminium	stainless steel
Gypsum mortar and mortars containing gypsum	⊖	⊖	⊖	⊖	⊖	✓	✓	✓	✓	✓
Lime plaster	✓	✓	✓	✓ ²	✓	✓	✓	✓	✓ ²	✓
Lime cement plaster	✓	✓	✓	✓ ²	✓	✓	✓	✓	✓ ²	✓
Cement plaster	✓	✓	✓	✓ ²	✓	✓	✓	✓	✓ ²	✓
Silicate plaster	✗ ¹	✓	✓	✓ ²	✓	✗ ¹	✓	✓	✓ ²	✓
Silicone resin plaster	✗ ¹	✓	✓	✓	✓	✗ ¹	✓	✓	✓	✓
Synthetic resin plaster	✗ ¹	✓	✓	✓	✓	✗ ¹	✓	✓	✓	✓
One-coat plaster (single layer)	✗	✓	✓	✓ ²	✓	✓	✓	✓	✓ ²	✓
Insulating plaster	✓	✓	✓	⊖	✓	✓	✓	✓	✓	✓
Renovating plaster	✗	✗	✗	✗	✓	✗	✗	✗	✗	✓
Clay plasters	⊖	⊖	⊖	⊖	⊖	✗	✓	✗	✓ ²	✓
Reinforcement plaster organic	✗	✓	✗	✓	✓	✗	✓	✗	✓	✓
Reinforcement plaster mineral	✓	✓	✓	✓ ²	✓	✓	✓	✓	✓ ²	✓
Adhesive plaster	✓	✓	✓	✓	✓	✓	✓	✓	✓	✓
Caption	¹⁾ In the case of synthetic resin, silicone resin or silicate finishing plasters/top coats on mineral substrates, incorporated galvanised profiles are to be protected additionally with a quartz filled, organically bound plaster primer (not thinned). ²⁾ Aluminium with base coat.									
	permitted			not permitted			not suitable			

COMMENTS

Please read the product information and the additional information at the different drawings.

- Galvanised profiles should not come into contact with aluminium and stainless steel profiles.
- For interior plaster profiles, the profile edge should remain visible or be covered, depending on the specification (single-layer or two-layer plaster).
- All exterior plaster profiles without PVC edge must be completely covered with plaster so that the profile edge is no longer visible. The covering must be at least the grain thickness of the finishing plaster (preferably at least 3 mm).

- Galvanised profiles with a smooth PVC edge must not be plastered over. After plastering, the PVC edge must be cleaned immediately.
- Galvanised profiles with a rough surface edge may be plastered over.
- For expansion joints, the joint area must remain open and free of mortar/plaster.
- In the case of galvanised profiles with coating, ensure that the coating is not damaged.
- Observe the leaflets „Planning and application of metallic plaster profiles in exterior and interior areas“ (www.euro-profiles.com) and „Plaster and dry construction in damp rooms“ (www.zdb.de).



GENERAL INFORMATION

- ▶ Various plaster profiles made of galvanized steel, aluminum with coating, stainless steel, plastic or material combinations are used for internal plastering.
- ▶ Only special profiles may be used for plasters in Wet rooms (see chapter on Wet rooms).
- ▶ When using pasty finishing plasters (silicate/silicone resin/dispersion plasters), preferably use profiles made of white aluminum or stainless steel. When using galvanized profiles, protect them additionally with a quartz-filled, organically bound plaster primer (undiluted).
- ▶ Galvanized profiles with the marking „Z“ are equipped with increased zinc coating for increased corrosion protection and increased safety.
- ▶ Cut metal profiles with hand shears. Never cut galvanized profiles with a cutting disc. Process stainless steel profiles only with stainless steel tools and cut them with a cutting disc recommended for stainless steel. Cut PVC profiles to the required installation dimension using suitable PVC shears (e.g. Protektor profile shears).
- ▶ Remove any nails used for pre-fixing before plastering.
- ▶ Attach the profiles with suitable mortar or with the plaster mortar to be used and align them flush and plumb.
- ▶ The heads of the plastering gauges must not protrude; re-smoothing may be necessary.
- ▶ For internal plaster profiles, the profile edge should remain visible or be covered, depending on the specification (single-layer or two-layer plaster).
- ▶ Clean flush metal parts, e.g. profile heads and PVC parts immediately after plastering.
- ▶ Ensure good ventilation after plastering.
- ▶ Store all profiles in a dry place! Additionally, store PVC profiles in a cool and frost-free place, horizontally and lying flat.

All standards and guidelines on the subject of plastering must be observed in their current version, in particular the following leaflet:

- Leaflet for the planning and application of metallic plaster profiles in external and internal areas from the European Association of Plaster Profile Manufacturers.

The product information as well as the additional information with the respective product illustrations in this catalogue and the further notes in our product data sheets and processing instructions on our homepage must be observed!

For the selection of metallic plaster profiles, please refer to the table for profile selection according to mortar types, for the selection of plastering strips and plastering sealing strips, please refer to the corresponding selection tables according to movement classes and areas of application in this catalogue, as well as the complete instructions for the selection, processing and installation of our plastering strips and plastering sealing strips on our homepage.



CORNER PROFILES

Corner bead for interior plaster

Aluminium corner profile for filler and thin-layer plaster of 3 mm and thicker in interior areas.

Stainless steel version: 2274

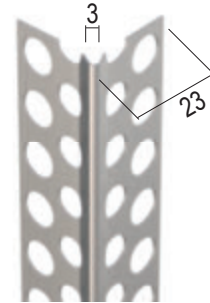

Item number	Plaster thickness (mm)	Length (cm)	Order number	Material	Package/ Large pack
9074	3 mm	250	107593	Aluminum natural	25 PCS / 250 BUN
	3 mm	300	107595	Aluminum natural	25 PCS / 250 BUN

Corner bead for interior plaster

Aluminium corner profile for thin-layer plaster of 5 mm and thicker for interior areas. Use profiles in accordance with data sheet Planning and Application of Metallic Plaster Profiles.

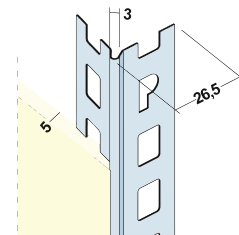

Item number	Plaster thickness (mm)	Length (cm)	Order number	Material	Package/ Large pack
90881	5 mm	220	112228	Aluminum natural	25 PCS / 120 BUN
	5 mm	260	112229	Aluminum natural	25 PCS / 120 BUN
	5 mm	300	112230	Aluminum natural	25 PCS / 120 BUN

Corner bead for interior plaster

Galvanised steel corner profile for filler and thin-layer plaster of 3 mm and thicker in interior areas.

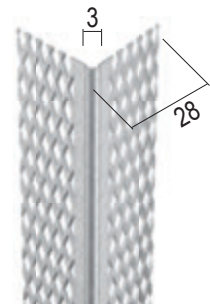

Item number	Plaster thickness (mm)	Length (cm)	Order number	Material	Package/ Large pack
1087	3 mm	250	109153	Galvanised steel	50 PCS / 47 BOX
	3 mm	300	109155	Galvanised steel	50 PCS / 47 BOX

Corner bead for interior plaster

Stainless steel corner profile for filler and thin-layer plaster of 3 mm and thicker in interior areas.

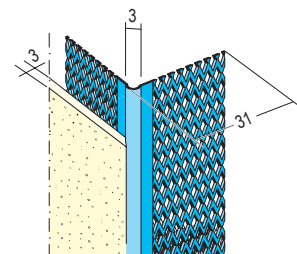

Item number	Plaster thickness (mm)	Length (cm)	Order number	Material	Package/ Large pack
1027	3 mm	260	119771	Galvanised steel	50 PCS / 100 BOX
	3 mm	300	119774	Galvanised steel	50 PCS / 100 BOX

Corner bead for interior plaster

Corner profile made of aluzinc steel, for thin-layer plaster of 5 mm and thicker in interior areas.

Item number	Plaster thickness (mm)	Length (cm)	Order number	Material	Package/ Large pack
1088	5 mm	200	108510	Steel, aluzinc	25 PCS / 120 BUN
	5 mm	220	108532	Steel, aluzinc	25 PCS / 120 BUN
	5 mm	250	108270	Steel, aluzinc	25 PCS / 120 BUN
	5 mm	260	108243	Steel, aluzinc	25 PCS / 120 BUN
	5 mm	270	108533	Steel, aluzinc	25 PCS / 120 BUN
	5 mm	280	115168	Steel, aluzinc	25 PCS / 120 BUN
	5 mm	300	108244	Steel, aluzinc	25 PCS / 120 BUN

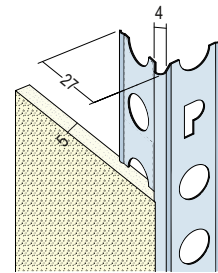

Corner bead for interior plaster

Corner profile made of aluzinc Steel, for thin-layer plaster of 5 mm and thicker for interior areas. Use profiles in accordance with data sheet Planning and Application of Metallic Plaster Profiles.

Item number	Plaster thickness (mm)	Length (cm)	Order number	Material	Package/ Large pack
10881	5 mm	200	114934	Steel, aluzinc	25 PCS / 100 BUN
	5 mm	220	114938	Steel, aluzinc	25 PCS / 100 BUN
	5 mm	250	114939	Steel, aluzinc	25 PCS / 100 BUN
	5 mm	260	114940	Steel, aluzinc	25 PCS / 100 BUN
	5 mm	270	114941	Steel, aluzinc	25 PCS / 100 BUN
	5 mm	280	114942	Steel, aluzinc	25 PCS / 100 BUN
	5 mm	300	114943	Steel, aluzinc	25 PCS / 100 BUN

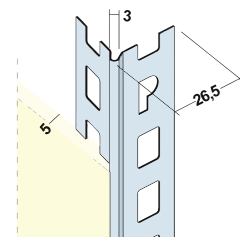

Corner bead for interior plaster

Corner profile made of galvanised steel, for thin-layer plaster of 6 mm and thicker in interior areas.

Aluminium version : 9104

Item number	Plaster thickness (mm)	Length (cm)	Order number	Material	Package/ Large pack
1084	6 mm	250	100789	Galvanised steel	25 PCS / 77 BUN

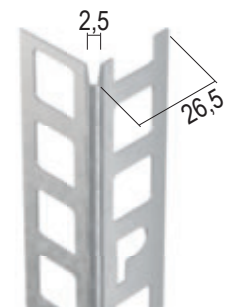

Corner bead for the switchover from to dry lining

Corner profile made of galvanised steel for transitions from drywall of 2 mm and thicker to plaster of 8 mm and thicker.

Item number	Plaster thickness (mm)	Length (cm)	Order number	Material	Package/ Large pack
1058	8 / 2 mm	260	108993	Galvanised steel	15 PCS / 132 BUN

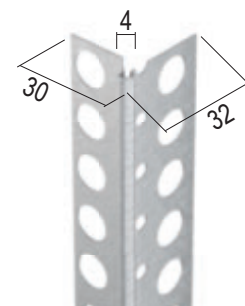

CORNER PROFILES

Corner bead for interior plaster

Corner profile made of galvanised steel for interior plaster of 8 mm and thicker.

Aluminium version : 9100

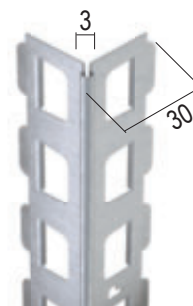

Item number	Plaster thickness (mm)	Length (cm)	Order number	Material	Package/ Large pack
1026	8 mm	250	100095	Galvanised steel	25 PCS / 66 BUN
	8 mm	300	102472	Galvanised steel	25 PCS / 66 BUN
1018	10 mm	200	100045	Galvanised steel	25 PCS / 66 BUN
	10 mm	225	100052	Galvanised steel	25 PCS / 66 BUN
	10 mm	250	100054	Galvanised steel	25 PCS / 66 BUN
	10 mm	260	103058	Galvanised steel	25 PCS / 66 BUN
	10 mm	275	100056	Galvanised steel	25 PCS / 66 BUN
	10 mm	300	100061	Galvanised steel	25 PCS / 66 BUN

Corner bead for interior plaster

Corner profile made of galvanised steel for interior plaster of 8 mm and thicker.

Rounding off radius: 4,75 mm

Stainless steel version: 2215

Notes:

Specially developed for schools and kindergartens. Satisfies the german guidelines and requirements of the statutory accident prevention regulations. See technical information.

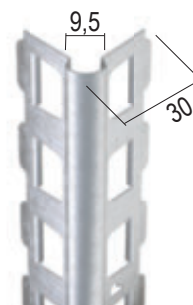

Item number	Plaster thickness (mm)	Length (cm)	Order number	Material	Package/ Large pack
1015	8 mm	240	100555	Galvanised steel	25 PCS / 66 BUN
	8 mm	250	100563	Galvanised steel	25 PCS / 66 BUN
	8 mm	300	100568	Galvanised steel	25 PCS / 66 BUN

Corner bead for interior plaster

Corner profile made of galvanised steel for interior plaster of 8 mm and thicker.

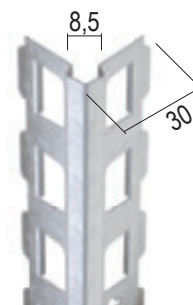

Item number	Plaster thickness (mm)	Length (cm)	Order number	Material	Package/ Large pack
1017	8 mm	200	100587	Galvanised steel	25 PCS / 66 BUN
	8 mm	225	100604	Galvanised steel	25 PCS / 66 BUN
	8 mm	250	100614	Galvanised steel	25 PCS / 66 BUN
	8 mm	260	100616	Galvanised steel	25 PCS / 66 BUN
	8 mm	270	100617	Galvanised steel	25 PCS / 66 BUN
	8 mm	300	102964	Galvanised steel	25 PCS / 66 BUN

Inside corner bead for interior plaster

Corner profile made of galvanised steel for inside corners and interior plaster of 8 mm and thicker.

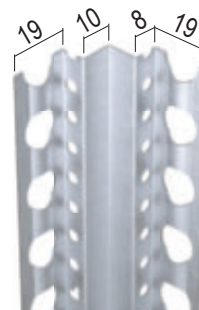

Item number	Plaster thickness (mm)	Length (cm)	Order number	Material	Package/ Large pack
1004	8 mm	260	109646	Galvanised steel	25 PCS / 132 BUN

Corner bead for interior plaster

Corner profile made of galvanised steel for various interior plaster thicknesses. In the reveal area additionally for different plaster thicknesses variable applicable.

Aluminium version : 91051
Stainless steel version: 2251



Item number	Plaster thickness (mm)	Length (cm)	Order number	Material	Package/ Large pack
1051	9 mm	250	100595	Galvanised steel	15 PCS / 100 BUN
	9 mm	300	103569	Galvanised steel	15 PCS / 88 BUN

Corner bead for interior plaster

Corner profile made of galvanised steel with thicker zinc coating for increased protection against corrosion, for interior plaster of 10 mm and thicker.

Aluminium version : 9007

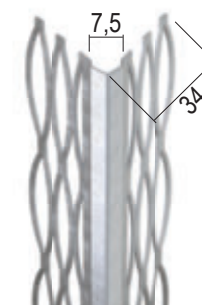

Item number	Plaster thickness (mm)	Length (cm)	Order number	Material	Package/ Large pack
1007Z	10 mm	200	106131	Galvanised steel	25 PCS / 80 BUN
	10 mm	225	106125	Galvanised steel	25 PCS / 80 BUN
	10 mm	250	105921	Galvanised steel	25 PCS / 81 BUN
	10 mm	260	105920	Galvanised steel	25 PCS / 81 BUN
	10 mm	275	106025	Galvanised steel	25 PCS / 81 BUN
	10 mm	300	105922	Galvanised steel	25 PCS / 81 BUN

Corner bead for interior plaster

Corner profile made of galvanised steel for interior plaster of 10 mm and thicker. Use profiles in accordance with data sheet Planning and Application of Metallic Plaster Profiles.

Aluminium version : 9007

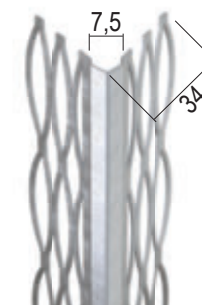

Item number	Plaster thickness (mm)	Length (cm)	Order number	Material	Package/ Large pack
1007	10 mm	150	100000	Galvanised steel	25 PCS / 80 BUN
	10 mm	160	100094	Galvanised steel	25 PCS / 80 BUN
	10 mm	180	100096	Galvanised steel	25 PCS / 80 BUN
	10 mm	200	100383	Galvanised steel	25 PCS / 80 BUN
	10 mm	220	100399	Galvanised steel	25 PCS / 80 BUN
	10 mm	225	100403	Galvanised steel	25 PCS / 80 BUN
	10 mm	250	100092	Galvanised steel	25 PCS / 81 BUN
	10 mm	260	100414	Galvanised steel	25 PCS / 81 BUN
	10 mm	270	100425	Galvanised steel	25 PCS / 81 BUN
	10 mm	275	100429	Galvanised steel	25 PCS / 81 BUN
	10 mm	280	103101	Galvanised steel	25 PCS / 81 BUN
	10 mm	300	100437	Galvanised steel	25 PCS / 81 BUN

CORNER PROFILES

Corner bead for interior plaster

Corner profile made of galvanised steel for interior plaster of 10 mm and thicker.

Aluminium version : 9007

Item number	Plaster thickness (mm)	Length (cm)	Order number	Material	Package/ Large pack
10077	10 mm	150	106478	Galvanised steel	25 PCS / 80 BUN
	10 mm	160	115179	Galvanised steel	25 PCS / 80 BUN
	10 mm	200	107991	Galvanised steel	25 PCS / 80 BUN
	10 mm	220	106513	Galvanised steel	25 PCS / 80 BUN
	10 mm	225	114633	Galvanised steel	25 PCS / 80 BUN
	10 mm	250	107038	Galvanised steel	25 PCS / 81 BUN
	10 mm	260	106477	Galvanised steel	25 PCS / 81 BUN
	10 mm	270	107945	Galvanised steel	25 PCS / 81 BUN
	10 mm	275	106480	Galvanised steel	25 PCS / 81 BUN
	10 mm	280	107965	Galvanised steel	25 PCS / 81 BUN
	10 mm	300	106514	Galvanised steel	25 PCS / 81 BUN

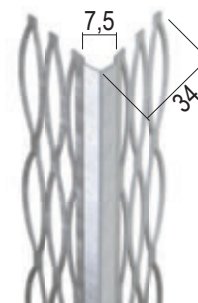

Corner bead for interior plaster

Corner bead made of aluzinc steel for interior plaster of 10 mm and thicker.

Item number	Plaster thickness (mm)	Length (cm)	Order number	Material	Package/ Large pack
1007A	10 mm	260	108297	Steel, aluzinc	25 PCS / 81 BUN
	10 mm	300	108298	Steel, aluzinc	25 PCS / 81 BUN

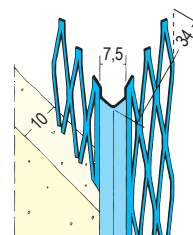

Corner bead for interior plaster

Aluminium corner profile for interior plasters of 10 mm and thicker.

Item number	Plaster thickness (mm)	Length (cm)	Order number	Material	Package/ Large pack
9007	10 mm	260	108400	Aluminum natural	25 PCS / 81 BUN
	10 mm	275	108290	Aluminum natural	25 PCS / 81 BUN
	10 mm	300	108291	Aluminum natural	25 PCS / 81 BUN

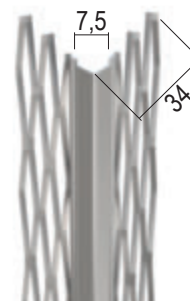

Corner bead for interior plaster

Corner profile made of galvanised steel for interior plaster of 10 mm and thicker.

Rounding off radius: 3,75 mm

Notes:

Specially developed for schools and kindergartens. Satisfies the german guidelines and requirements of the statutory accident prevention regulations. See technical information.

Item number	Plaster thickness (mm)	Length (cm)	Order number	Material	Package/ Large pack
1005	10 mm	250	100043	Galvanised steel	25 PCS / 81 BUN
	10 mm	260	102763	Galvanised steel	25 PCS / 81 BUN
	10 mm	300	100070	Galvanised steel	25 PCS / 81 BUN

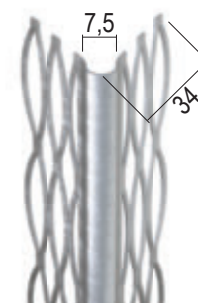

Corner bead 135° for interior plaster and exterior render

Corner profile made of galvanised steel with corner execution of 135° and thicker zinc coating for increased protection against corrosion, for interior and exterior plaster of 10 mm and thicker.

Angular position: 135

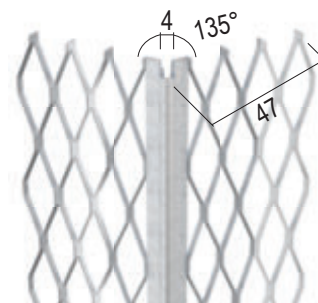

SALE

Item number	Plaster thickness (mm)	Length (cm)	Order number	Material	Package/ Large pack
1044Z	10 mm	250	100540	Galvanised steel	15 PCS / 42 BUN

Corner bead for interior plaster and exterior render

Corner profile made of galvanised steel with thicker zinc coating for increased protection against corrosion, for interior and exterior plaster of 10 mm and thicker.



POWER GRIP

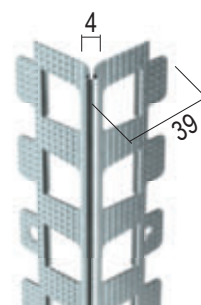

Item number	Plaster thickness (mm)	Length (cm)	Order number	Material	Package/ Large pack
1022Z	10 mm	250	117723	Galvanised steel	15 PCS / 56 BUN
	10 mm	300	117724	Galvanised steel	15 PCS / 56 BUN

Corner bead for interior plaster and exterior render

Corner profile made of galvanised steel with notched wall flanges and PVC coating for creating rounded arches on interior and exterior plaster of 12 mm and thicker.

Colour: 10 - white
Rounding off radius: 4 mm

Notes:
Smallest possible radius: 50 cm.
Specially developed for schools and kindergartens. Satisfies the german guidelines and requirements of the statutory accident prevention regulations. See technical information.

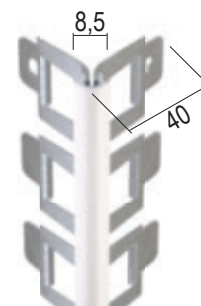

Item number	Plaster thickness (mm)	Length (cm)	Order number	Material	Package/ Large pack
1041	12 mm	250	100486	Galvanised steel, with PVC coating	15 PCS / 35 BOX

Corner bead for interior plaster

Corner protection beads made of galvanised steel for interior plaster of 20 mm and thicker.

Rounding off radius: 2,5 mm
Stainless steel version: 7483

Notes:
Specially developed for schools and kindergartens. Satisfies the german guidelines and requirements of the statutory accident prevention regulations. See technical information.

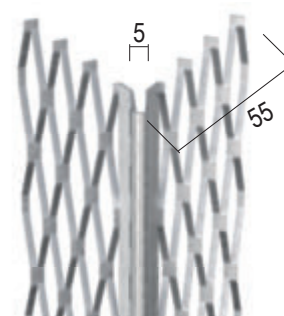

Item number	Plaster thickness (mm)	Length (cm)	Order number	Material	Package/ Large pack
7426	20 mm	300	102491	Galvanised steel	25 PCS / 72 BOX

CORNER PROFILES

Corner bead for interior plaster

Corner profile made of aluzinc steel, for surface plaster in interior areas, sharp-tipped head. Use profiles in accordance with data sheet Planning and Application of Metallic Plaster Profiles.

Item number	Plaster thickness (mm)	Length (cm)	Order number	Material	Package/ Large pack
10882	2 mm	275	115335	Steel, aluzinc	60 PCS / 30 BOX
	2 mm	305	115336	Steel, aluzinc	60 PCS / 30 BOX
	2 mm	305	119695	Steel, aluzinc	60 PCS / 25 BOX

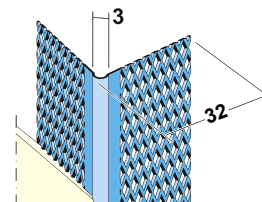

Sliding anchor small

Galvanised steel sliding anchor for attaching corner protection beads.

Suitable for product: 2026

Notes:

Can be attached by encasing in concrete or by screwing on. Required quantity: 2 pcs./m.

Item number	Order number	Material	Package/ Large pack
2072	101211	Galvanised steel	20 PC / 87 BOX



Sliding anchor large

Galvanised steel sliding anchor for attaching corner protection beads.

Suitable for product: 2027

Notes:

Can be attached by encasing in concrete or by screwing on. Required quantity: 2 pcs./m.

Item number	Order number	Material	Package/ Large pack
2073	101225	Galvanised steel	20 PC / 87 BOX



Corner protection profile

Stainless steel corner protection beads protect corners in high-trafficked rooms and can be attached mechanically. Matt surface. Plaster thickness with anchor = 16 mm.

Rounding off radius: 4 mm

Suitable for product: 2072

Notes:

Specially developed for schools and kindergartens. Satisfies the german guidelines and requirements of the statutory accident prevention regulations. See technical information.

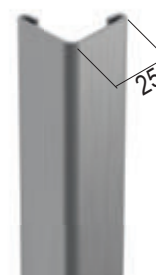

Item number	Plaster thickness (mm)	Length (cm)	Order number	Material	Package/ Large pack
2026	16 mm	200	101159	Stainless steel	15 PCS / 175 BUN
	16 mm	250	101161	Stainless steel	15 PCS / 175 BUN
	16 mm	300	101164	Stainless steel	15 PCS / 175 BUN

Corner protection profile

Stainless steel corner protection beads protect corners in high-trafficked rooms and can be attached mechanically.
Matt surface.
Plaster thickness with anchor = 21 mm.

Rounding off radius: 10 mm
Suitable for product: 2073

Notes:
Specially developed for schools and kindergartens. Satisfies the german guidelines and requirements of the statutory accident prevention regulations. See technical information.

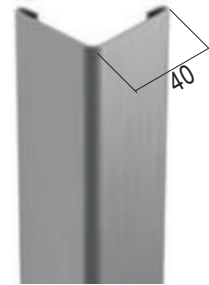

Item number	Plaster thickness (mm)	Length (cm)	Order number	Material	Package/ Large pack
2027	21 mm	200	101172	Stainless steel	6 PCS / 100 BUN
	21 mm	250	101175	Stainless steel	6 PCS / 100 BUN
	21 mm	300	101179	Stainless steel	6 PCS / 100 BUN

Corner protection profile

Stainless steel corner protection beads protect corners in high-trafficked rooms and can be glued on at any time.
Polished surface, 320 grit.

Rounding off radius: 3,5 mm
Notes:

Specially developed for schools and kindergartens. Satisfies the german guidelines and requirements of the statutory accident prevention regulations. See technical information.

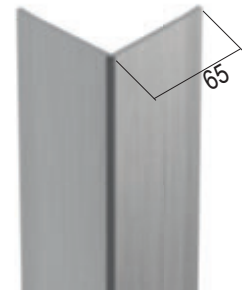

Item number	Plaster thickness (mm)	Length (cm)	Order number	Material	Package/ Large pack
2066		250	101221	Stainless steel	6 PCS / 63 BUN

Corner protection profile

Stainless steel corner protection beads protect corners in high-trafficked rooms and can be glued on at any time.
Brushed surface, 320 grit.

Rounding off radius: 3,5 mm
Notes:

Specially developed for schools and kindergartens. Satisfies the german guidelines and requirements of the statutory accident prevention regulations. See technical information.

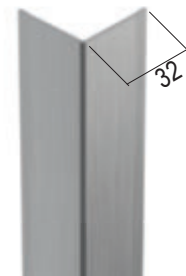

Item number	Plaster thickness (mm)	Length (cm)	Order number	Material	Package/ Large pack
2041		200	101194	Stainless steel	6 PCS / 150 BUN
		250	101201	Stainless steel	6 PCS / 150 BUN

FLATNESS GUIDES

Depth gauge profile for interior plaster

Depth gauge profile made of galvanised steel for interior plaster of 6 mm and thicker.

Aluminium version : 9003
Stainless steel version: 2206



Item number	Plaster thickness (mm)	Length (cm)	Order number	Material	Package/ Large pack
1106	6 mm	250	111969	Galvanised steel	50 PCS / 80 BUN
	6 mm	260	111970	Galvanised steel	50 PCS / 80 BUN
	6 mm	275	111971	Galvanised steel	50 PCS / 70 BUN
	6 mm	300	111972	Galvanised steel	50 PCS / 70 BUN

Depth gauge profile for interior plaster

Depth gauge profile made of galvanised steel for interior plaster of 6 mm and thicker.

Processing instructions: In damp rooms, stainless steel profiles are generally to be installed. The exception is domestic kitchens and bathrooms. Galvanized profiles must be removed after completion of the flush.



Item number	Plaster thickness (mm)	Length (cm)	Order number	Material	Package/ Large pack
11066	6 mm	250	119116	Galvanised steel	50 PCS / 80 BUN
	6 mm	260	119117	Galvanised steel	50 PCS / 80 BUN
	6 mm	275	119118	Galvanised steel	50 PCS / 70 BUN
	6 mm	300	119119	Galvanised steel	50 PCS / 70 BUN

Depth gauge profile for interior plaster

Depth gauge profile made of aluzinc steel for interior plaster of 6 mm and thicker.

Material thickness (mm): 0,5 mm

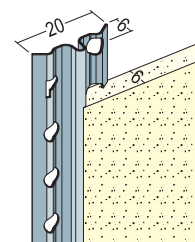

Item number	Plaster thickness (mm)	Length (cm)	Order number	Material	Package/ Large pack
1089	6 mm	260	111930	Steel, aluzinc	50 PCS / 80 BUN
	6 mm	300	115326	Steel, aluzinc	43 PCS / 80 BUN

Depth gauge profile for interior plaster

Depth gauge profile made of galvanised steel for interior plaster of 8 mm and thicker.

Aluminium version : 9008
Stainless steel version: 2208



Item number	Plaster thickness (mm)	Length (cm)	Order number	Material	Package/ Large pack
1108	8 mm	250	111995	Galvanised steel	50 PCS / 100 BUN
	8 mm	260	111996	Galvanised steel	50 PCS / 90 BUN
	8 mm	275	111998	Galvanised steel	50 PCS / 90 BUN
	8 mm	300	111999	Galvanised steel	50 PCS / 80 BUN

Depth gauge profile for interior plaster

Depth gauge profile made of galvanised steel for interior plaster of 10 mm and thicker.

Aluminium version : 9005
Stainless steel version: 2205



Item number	Plaster thickness (mm)	Length (cm)	Order number	Material	Package/ Large pack
1105	10 mm	250	111965	Galvanised steel	50 PCS / 64 BUN
	10 mm	260	111966	Galvanised steel	50 PCS / 64 BUN
	10 mm	275	111967	Galvanised steel	50 PCS / 56 BUN
	10 mm	300	111968	Galvanised steel	50 PCS / 56 BUN



Depth gauge profile for interior plaster

Depth gauge profile made of galvanised steel for interior plaster of 10 mm and thicker.

Processing instructions: In damp rooms, stainless steel profiles are generally to be installed. The exception is domestic kitchens and bathrooms. Galvanized profiles must be removed after completion of the flush.

Item number	Plaster thickness (mm)	Length (cm)	Order number	Material	Package/ Large pack
11055	10 mm	250	119110	Galvanised steel	50 PCS / 64 BUN
	10 mm	260	119111	Galvanised steel	50 PCS / 64 BUN
	10 mm	275	119112	Galvanised steel	50 PCS / 56 BUN
	10 mm	300	119113	Galvanised steel	50 PCS / 56 BUN



Depth gauge profile for interior plaster

Depth gauge profile made of galvanised steel for interior plaster of 12 mm and thicker.

Item number	Plaster thickness (mm)	Length (cm)	Order number	Material	Package/ Large pack
1104	12 mm	250	111992	Galvanised steel	50 PCS / 56 BUN



SHADOW JOINT PROFILES

Connecting profile for interior plaster

Shadow joint profile made of galvanised steel for interior plaster of 10 mm and thicker.

Shadow gap: 15 mm
Stainless steel version: 2241

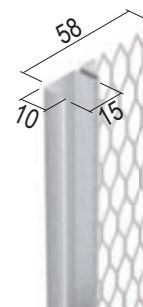

Item number	Plaster thickness (mm)	Length (cm)	Order number	Material	Package/ Large pack
1312	10 mm	250	115992	Galvanised steel	15 PCS / 47 BOX
	10 mm	300	115993	Galvanised steel	15 PCS / 47 BOX

Connecting profile for interior plaster

Shadow joint profile made of galvanised steel for interior plaster of 10 mm and thicker.

Shadow gap: 20 mm

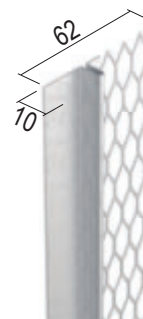

Item number	Plaster thickness (mm)	Length (cm)	Order number	Material	Package/ Large pack
1306	10 mm	250	115990	Galvanised steel	15 PCS / 47 BOX
	10 mm	300	115991	Galvanised steel	15 PCS / 47 BOX

Connecting profile for interior plaster

Shadow joint profile made of galvanised steel for interior plaster of 14 mm and thicker.

Shadow gap: 20 mm
Stainless steel version: 2263



Item number	Plaster thickness (mm)	Length (cm)	Order number	Material	Package/ Large pack
1301	14 mm	250	115988	Galvanised steel	15 PCS / 47 BOX
	14 mm	300	115989	Galvanised steel	150 PCS / 47 BOX

Stop profile for interior plaster

Plaster stop profile made of galvanised steel for interior plaster of 3 mm and thicker.

Aluminium version : 9136
Stainless steel version: 2136



Item number	Plaster thickness (mm)	Length (cm)	Order number	Material	Package/ Large pack
1236	3 mm	250	115636	Galvanised steel	25 PCS / 180 BUN
	3 mm	260	115634	Galvanised steel	25 PCS / 180 BUN
	3 mm	300	115635	Galvanised steel	25 PCS / 150 BUN

Stop profile for interior plaster

Aluminium plaster stop profile for interior plasters of 3 mm and thicker

Stainless steel version: 2136



Item number	Plaster thickness (mm)	Length (cm)	Order number	Material	Package/ Large pack
9136	3 mm	250	101938	Aluminum natural	25 PCS / 144 BUN
	3 mm	300	108708	Aluminum natural	25 PCS / 144 BUN

Stop profile for interior plaster

Plaster stop profile made of galvanized steel for interior plaster of 6 mm and thicker.

Aluminium version : 9123
Stainless steel version: 2135

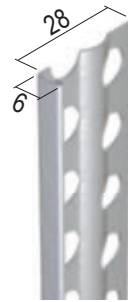

Item number	Plaster thickness (mm)	Length (cm)	Order number	Material	Package/ Large pack
1216	6 mm	250	115628	Galvanised steel	25 PCS / 180 BUN
	6 mm	260	115626	Galvanised steel	25 PCS / 180 BUN
	6 mm	270	115950	Galvanised steel	25 PCS / 180 BUN
	6 mm	300	115627	Galvanised steel	25 PCS / 150 BUN

Stop profile for interior plaster

Plaster stop profile made of galvanized steel for interior plaster of 6 mm and thicker.

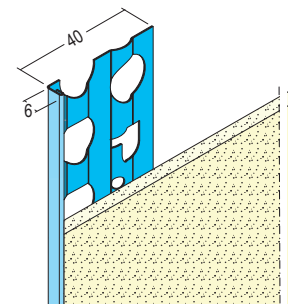

Item number	Plaster thickness (mm)	Length (cm)	Order number	Material	Package/ Large pack
12164	6 mm	260	118641	Steel, aluzinc	25 PCS / 100 BUN
	6 mm	300	118642	Steel, aluzinc	25 PCS / 100 BUN

Stop profile for interior plaster

Plaster stop profile made of aluzinc steel for interior plaster of 6 mm and thicker.

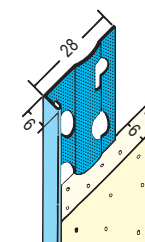

Item number	Plaster thickness (mm)	Length (cm)	Order number	Material	Package/ Large pack
1216A	6 mm	260	115619	Steel, aluzinc	25 PCS / 180 BUN
	6 mm	300	115620	Steel, aluzinc	25 PCS / 150 BUN

PLASTER STOP PROFILES

Stop profile for interior plaster

Plaster stop profile made of galvanised steel for interior plaster of 9 mm and thicker.

Aluminium version : 9111
Stainless steel version: 2178

Item number	Plaster thickness (mm)	Length (cm)	Order number	Material	Package/ Large pack
1211	9 mm	250	107972	Galvanised steel	25 PCS / 100 BUN
	9 mm	260	107974	Galvanised steel	25 PCS / 100 BUN
	9 mm	300	107973	Galvanised steel	25 PCS / 90 BUN
1210	14 mm	250	107946	Galvanised steel	25 PCS / 80 BUN
	14 mm	300	107947	Galvanised steel	25 PCS / 80 BUN

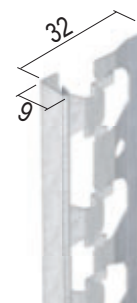

Stop profile for interior plaster

Plaster stop profile made of galvanised steel for interior plaster of 9 mm and thicker. Created using folding method.

Item number	Plaster thickness (mm)	Length (cm)	Order number	Material	Package/ Large pack
12111	9 mm	250	119070	Galvanised steel	25 PCS / 100 BUN
	9 mm	260	119075	Galvanised steel	25 PCS / 100 BUN
	9 mm	300	119076	Galvanised steel	25 PCS / 90 BUN

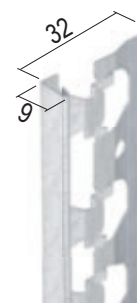

Stop profile for interior plaster

Aluminium plaster stop profile for interior plasters of 10 mm and thicker. With an extra-long plastering leg.

Item number	Plaster thickness (mm)	Length (cm)	Order number	Material	Package/ Large pack
9135	10 mm	250	105937	Aluminum natural	20 PCS / 150 BUN

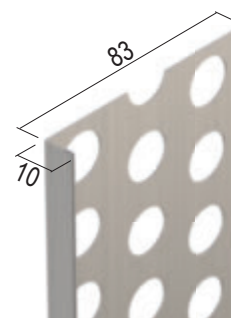

Stop profile for interior plaster

Plaster stop profile made of galvanised steel for interior plaster of 10 mm and thicker. With expanded metal wing and additional plaster removal edge.

Item number	Plaster thickness (mm)	Length (cm)	Order number	Material	Package/ Large pack
1231	10 mm	250	102319	Galvanised steel	25 PCS / 70 BUN
	10 mm	260	102322	Galvanised steel	25 PCS / 70 BUN
	10 mm	300	102327	Galvanised steel	25 PCS / 70 BUN
1235	10 mm	250	119040	Galvanised steel	24 PCS / 72 BUN
	10 mm	260	119041	Galvanised steel	24 PCS / 72 BUN
	10 mm	300	119042	Galvanised steel	24 PCS / 72 BUN

NEW

NEW

NEW

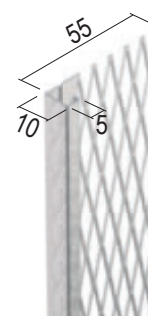

Stop profile for interior plaster

Stop profile made of aluzinked steel with filler perforation for 10 mm thick plasterboard.

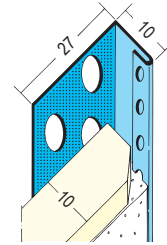

Item number	Plaster thickness (mm)	Length (cm)	Order number	Material	Package/ Large pack
1212A		300	115765	Steel, aluzinc	25 PCS / 100 BUN

Stop profile for interior plaster

Plaster stop profile made of galvanised steel for interior plaster of 12 mm and thicker.



Item number	Plaster thickness (mm)	Length (cm)	Order number	Material	Package/ Large pack
1218	12 mm	250	107449	Galvanised steel	25 PCS / 64 BUN
	12 mm	300	107450	Galvanised steel	25 PCS / 64 BUN
1220	18 mm	250	107468	Galvanised steel	25 PCS / 55 BUN
	18 mm	300	107469	Galvanised steel	25 PCS / 55 BUN

Stop profile for interior plaster

Plaster stop profile made of galvanised steel for interior plaster of 14 mm and thicker. With expanded metal wing and additional 5-mm plaster removal edge.

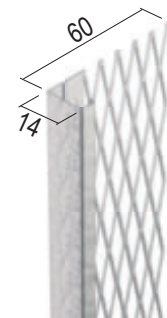

Item number	Plaster thickness (mm)	Length (cm)	Order number	Material	Package/ Large pack
1230	14 mm	250	102307	Galvanised steel	25 PCS / 60 BUN
	14 mm	300	102311	Galvanised steel	25 PCS / 60 BUN

Stop profile for interior plaster

Connection/stop profile made of galvanised steel for interior plaster of 14 mm and thicker.

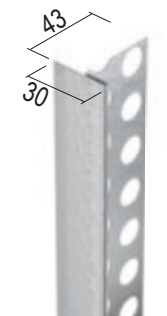

Item number	Plaster thickness (mm)	Length (cm)	Order number	Material	Package/ Large pack
1321	14 mm	300	101276	Galvanised steel	15 PCS / 65 BUN

BASE PROFILES

Base stop profile for interior plaster

Base stop profile made of galvanised steel for interior plaster of 9 mm and thicker.

Angular position: 110°

Item number	Plaster thickness (mm)	Length (cm)	Order number	Material	Package/ Large pack
1219	9 mm	250	107485	Galvanised steel	25 PCS / 60 BUN
	9 mm	300	107486	Galvanised steel	25 PCS / 60 BUN

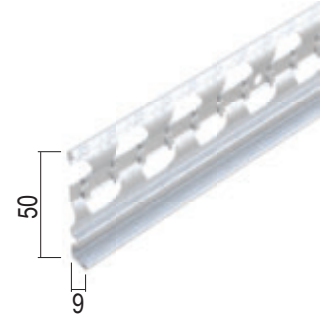

Base stop profile for interior plaster

Base stop profile made of galvanised steel for interior plaster of 15 mm and thicker.

Angular position: 110°

Stainless steel version: 2229

Item number	Plaster thickness (mm)	Length (cm)	Order number	Material	Package/ Large pack
1214	15 mm	300	107610	Galvanised steel	25 PCS / 60 BUN

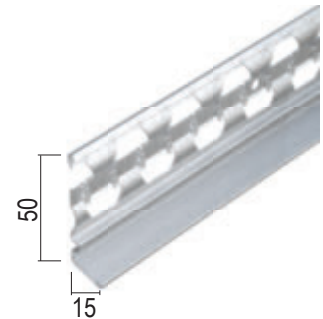

Expansion joint profile for interior plaster

Movement joint profile made of hard PVC and middle part made of soft PVC for interior and exterior plastering from 6 mm, for use on the surface and in the inside corner. Outdoors and in wet rooms only for vertical use.

Colour: 10 - white
Movement absorption tension/compression: +/-1,5 mm

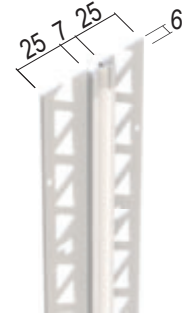

Item number	Plaster thickness (mm)	Length (cm)	Order number	Material	Package/ Large pack
3753	6 mm	275	110683	PVC	25 PCS / 36 BOX
3754	10 mm	275	110695	PVC	25 PCS / 36 BOX

Expansion joint profile for interior plaster

Expansion joint profile made of galvanized steel with increased zinc coating for interior plaster from 6 mm.

Movement absorption tension/compression: +/-5 mm
Stainless steel version: 2236;2135
Notes: See data sheet for possible profile combinations.

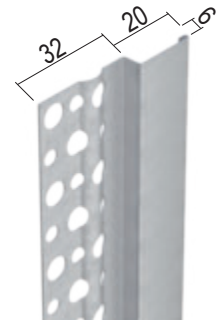

Item number	Plaster thickness (mm)	Length (cm)	Order number	Material	Package/ Large pack
1206Z	6 mm	250	100769	Galvanised steel	25 PCS / 130 BUN
	6 mm	300	100785	Galvanised steel	25 PCS / 130 BUN

Expansion joint profile for interior and exterior render

Movement joint profile made of galvanized steel and middle part made of soft PVC for interior and exterior plastering from 10 mm. Outdoors for vertical use only.

Colour: 10 - white
Stainless steel version: 7541
Movement absorption tension/compression: +/-1,5 mm

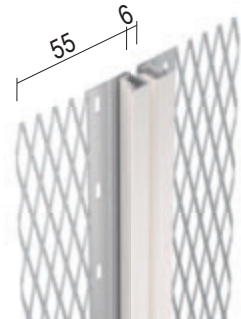

Item number	Plaster thickness (mm)	Length (cm)	Order number	Material	Package/ Large pack
7501	10 mm	300	102505	Galvanised steel, with PVC coating	10 PCS / 24 BOX
7503	14 mm	300	102506	Galvanised steel, with PVC coating	10 PCS / 24 BOX

Expansion joint profile for interior and exterior render

Movement joint profile made of stainless steel and middle part made of soft PVC for interior and exterior plastering from 10 mm. Outdoors and in wet rooms only for vertical use.

Colour: 10 - white
Movement absorption tension/compression: +/-1,5 mm

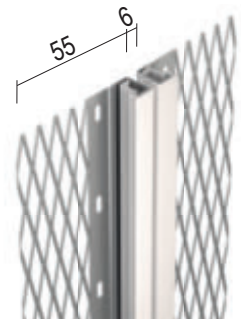

Item number	Plaster thickness (mm)	Length (cm)	Order number	Material	Package/ Large pack
7541	10 mm	300	102514	Stainless steel, with PVC coating	10 PCS / 24 BOX

JOINT PROFILES

Expansion joint profile for interior and exterior render

Profilé de joint de dilatation en acier inoxydable et partie médiane en PVC souple pour enduit intérieur et extérieur à partir de 10 mm, à utiliser en surface et dans le coin intérieur. En extérieur et dans des pièces humides uniquement pour une utilisation verticale.

Colour: 10 - white
Movement absorption tension/compression: +4/-3 mm

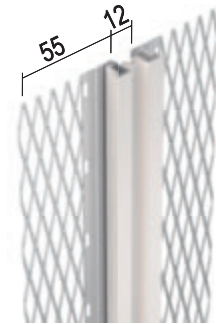

Item number	Plaster thickness (mm)	Length (cm)	Order number	Material	Package/ Large pack
7571	10 mm	300	102517	Stainless steel, with PVC coating	10 PCS / 24 BOX
7573	14 mm	300	102518	Stainless steel, with PVC coating	10 PCS / 24 BOX

Expansion joint profile for interior and exterior render

Expansion joint profile made of galvanized steel and middle part made of soft PVC for interior and exterior plastering from 14 mm, for use on the surface and in the inside corner. Outdoors for vertical use only.

Colour: 10 - white
Movement absorption tension/compression: +4/-3 mm

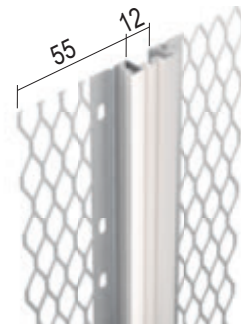

Item number	Plaster thickness (mm)	Length (cm)	Order number	Material	Package/ Large pack
7521	10 mm	300	102509	Galvanised steel, with PVC coating	10 PCS / 24 BOX
7523	14 mm	300	102511	Galvanised steel, with PVC coating	10 PCS / 24 BOX

Expansion joint profile for interior plaster

Expansion joint profile made of galvanized steel with increased zinc coating for interior plaster from 14 mm.

Movement absorption tension/compression: +/-10 mm
Notes: See data sheet for possible profile combinations.

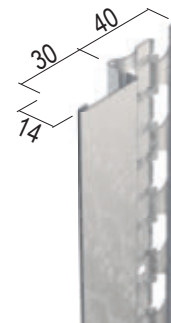

Item number	Plaster thickness (mm)	Length (cm)	Order number	Material	Package/ Large pack
1201Z	14 mm	250	108133	Galvanised steel	15 PCS / 81 BUN
	14 mm	300	108134	Galvanised steel	15 PCS / 81 BUN

Picture profile for interior plaster

Images bar made of galvanized steel for interior plaster from 12 mm.

Notes:
For extension of the picture strip connector 1113 to use an order separate. Matching picture strip article 1114.

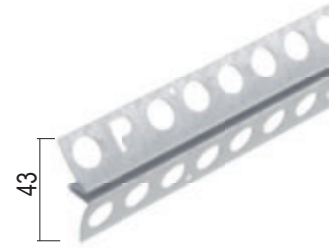

Item number	Plaster thickness (mm)	Length (cm)	Order number	Material	Package/ Large pack
1110	12 mm	250	100942	Galvanised steel	25 PCS / 42 BUN

Connector for Picture profile 1110 for interior plaster

Accessories for Picture profile 1110.

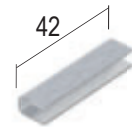

Item number	Plaster thickness (mm)	Length (cm)	Order number	Material	Package/ Large pack
1113		3	101003	Galvanised steel	20 PC / 4000 BEU

Picture hook for Picture profile 1110 for interior plaster

Accessories for Picture profile 1110.

Notes:
Only suitable for picture profile 1110.



Item number	Plaster thickness (mm)	Length (cm)	Order number	Material	Package/ Large pack
1114		3	102339	Brass	25 PC / 99 BOX

REINFORCING MESH INTERNAL PLASTERING

Barfix reinforcement fabric

Mesh size: 10 x 10 mm

Grammage: 140 g/m²

Item number	Width (mm)	Length (cm)	Order number	Material	Color	Package/ Large pack
14960	166	5	119716	Glass fiber	CD - blue	6 PC / 36 BOX
14961	200	5	119717	Glass fiber	CD - blue	5 PC / 30 BOX
14962	250	5	119718	Glass fiber	CD - blue	4 PC / 24 BOX
14963	330	5	119719	Glass fiber	CD - blue	3 PC / 18 BOX
14964	400	5	119720	Glass fiber	CD - blue	3 PC / 18 BOX



Reinforcing mesh interior plaster

Glass fibre mesh for the reinforcement of interior base plasters. Can be used for surface reinforcement and at transitions of e.g. wall connections, material changes, wall slots, roller shutter boxes, etc.

Mesh size: 5 x 5 mm

Grammage: 75 g/m²

Processing instructions: Features: Alkali-resistant, displacement-resistant, plasticizer-free

Item number	Fabric dimension	Order number	Material	Color	Package/ Large pack
14911	100 cm x 10 m	119790	Glass fiber	10 - white	10 M2 / 160 ROL
	100 cm x 50 m	119791	Glass fiber	10 - white	50 M2 / 48 ROL
	100 cm x 100 m	119792	Glass fiber	10 - white	100 M2 / 24 ROL
	50 cm x 50 m	119793	Glass fiber	10 - white	25 M2 / 96 ROL
	50 cm x 100 m	119794	Glass fiber	10 - white	50 M2 / 48 ROL
	33 cm x 50 m	119795	Glass fiber	10 - white	17 M2 / 144 ROL
	33 cm x 100 m	119796	Glass fiber	10 - white	33 M2 / 72 ROL
	25 cm x 100 m	119797	Glass fiber	10 - white	25 M2 / 96 ROL



Lath for interior plaster and exterior render (Stucanet 33)

Plaster board for interior and exterior plaster made of galvanized wire, with an intermediate layer made of moisture-absorbing cardboard.

Notes:
Panel size: 240 x 70 cm (1.68 m²)

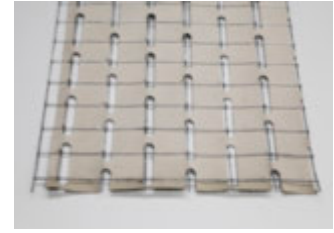

Item number	Plaster thickness (mm)	Length (cm)	Order number	Material	Package/ Large pack
17709	20 mm	258	116294	Galvanised steel	15 PC / 50 BUN

Lath for interior plaster and exterior render (Stucanet S)

Plaster board for interior and exterior plaster made of galvanized wire, with an intermediate layer made of moisture-absorbing cardboard.

Notes:
Panel size: 240 x 70 cm (1.68 m²)



Item number	Plaster thickness (mm)	Length (cm)	Order number	Material	Package/ Large pack
17710	20 mm	240	116295	Galvanised steel	15 PC / 25 BUN

Lath for interior plaster and exterior render (Stucanet SE)

Plaster board for interior and exterior plaster made of stainless steel wire, with an intermediate layer made of moisture-absorbing cardboard.

Notes:
Panel dimensions: 240 x 70 cm (1.68 m²)



Item number	Plaster thickness (mm)	Length (cm)	Order number	Material	Package/ Large pack
17708	20 mm	240	116293	Stainless steel	15 PC / 25 BUN

Glass fibre mesh for interior Plaster

Glass fibre mesh for internal plastering.
Roll width 12.5 cm, 4 x 4 mm, 75 g/m².

Processing instructions: Features: Alkali-resistant, displacement-resistant, plasticizer-free



Item number	Plaster thickness (mm)	Length (cm)	Order number	Material	Package/ Large pack
14912	10	118633	118633	Alkali-resistant glass fibre mesh	100 M / 192 ROL

Glass fibre mesh for interior Plaster

Glass fibre mesh for internal plastering.
Roll width 12,5 cm, 4 x 4 mm, 75 g/m².



Item number	Plaster thickness (mm)	Length (cm)	Order number	Material	Package/ Large pack
14913	10	118634	118634	Alkali-resistant glass fibre mesh	100 M / 96 ROL

PLASTER BASES

Glass fibre mesh for interior Plaster

Glass fibre mesh for internal plastering.
Roll width 50 cm, 4 x 4 mm, 75 g/m².

color value: 10 - white



Item number	Plaster thickness (mm)	Length (cm)	Order number	Material	Package/ Large pack
14914		10	118635	Alcali-resistant glass fibre mesh	100 M / 48 ROL

Glass fibre mesh for interior Plaster

Glass fibre mesh for internal plastering.
Roll width 100 cm, 4 x 4 mm, 75 g/m².

color value: 10 - white



Item number	Plaster thickness (mm)	Length (cm)	Order number	Material	Package/ Large pack
14915		10	118636	Alcali-resistant glass fibre mesh	100 M / 24 ROL



GENERAL INFORMATION

- Various plaster profiles made of galvanized steel, aluminum with coating, stainless steel, plastic or also material combinations are used for external rendering.
 - Galvanized steel profiles for external rendering either have an additional PVC coating in the profile head or are equipped with an increased zinc layer for increased corrosion protection and increased safety (marking „Z“).
 - We recommend the use of stainless-steel profiles for very exposed locations and facades exposed to heavy weather.
 - When using pasty finishing plasters (silicate/silicone resin/dispersion plasters), preferably use profiles made of white aluminum or stainless steel. For wire corner beads, use only those made of galvanized steel with additional organic coating (APP/APPA) or stainless steel (APE). Only use plaster profiles and wire corner beads made of galvanized steel without organic coating in outdoor areas with PVC coating or additionally protect them with a quartz-filled, organically bound plaster primer (undiluted).
 - Some galvanized profiles with PVC coating are manufactured with additional surface embossing for optimum plaster adhesion on the profile legs. Please note the „Power-Grip“ icon.
 - Galvanized profiles with PVC coating are also suitable for fine scratched plasters.
 - In areas in contact with the ground and/or plinth areas with influences such as snow accumulation, exposure to road salt or heavy splash water, plaster profiles made of corrosion-resistant material (e.g. stainless steel) should be used.
 - Cut metal profiles with hand shears. Never cut galvanized profiles with a cutting disc. Process stainless steel profiles only with stainless steel tools and cut with a cutting disc recommended for stainless steel. Cut PVC profiles to the required installation dimension using suitable PVC shears (e.g. Protektor profile shears).
 - Remove any nails used for pre-fixing before rendering.
 - Set the profiles with suitable mortar (no plaster or material containing plaster) and align them flush and plumb.
 - The heads of the plastering gauges must not protrude; re-smoothing may be necessary.
 - For internal plaster profiles, the profile edge should remain visible or be covered, depending on the specification (single-layer or two-layer plaster).
 - Clean flush metal parts, e.g. profile heads and PVC parts immediately after plastering.
 - Do not plaster over PVC coatings, clean immediately after plastering. If profile joints are required, push over PVC covers by approx. 10 cm as butt connector.
 - Galvanized profiles with rough edges may be plastered over.
 - All external rendering profiles without PVC edge must be completely covered with plaster so that the profile edge is no longer visible. The covering must be at least the grain thickness of the finishing plaster (preferably at least 3 mm).
 - Elastic middle parts of expansion joint profiles and metal surfaces that remain visible must be masked off before plastering. The masking strip must be removed immediately after plastering.
 - Store all profiles in a dry place! Also, store PVC profiles in a cool and frost-free place, horizontally and lying flat.
- All standards and guidelines on the subject of plaster must be observed in their current version, in particular the following leaflet:
- Leaflet for the planning and application of metallic plaster profiles in external and internal areas from the European Association of Plaster Profile Manufacturers.
 - Guideline „Façade plinth rendering / outdoor facilities“ from the Fachverband der Stuckateure für Ausbau und Fassade Baden-Württemberg (SAF) and other associations
 - Guideline „Metal Connections to Plaster, External Thermal Insulation and External Thermal Insulation Composite Systems“ from the Fachverband der Stuckateure für Ausbau und Fassade Baden-Württemberg (SAF) and other associations
 - Guideline „Connections to windows and roller shutters in plaster, external thermal insulation composite systems and drywall construction“ from the Fachverband der Stuckateure für Ausbau und Fassade Baden-Württemberg (SAF), the Fachverband Glas, Fenster, Fassade Baden-Württemberg and the Bundesverband Rollläden + Sonnenschutz e. V.
 - Leaflet „Formation of details with profiles and joint sealing tapes for external rendering and ETICS“ from the Association for Insulation Systems, Plaster and Mortar (VDPM)
 - „Processing Guideline for Plastering and Stop Profiles“ by the Austrian Working Group for Plaster (ÖAP).
- The product information as well as the additional information with the respective product illustrations in this catalogue and the further notes in our product data sheets and processing instructions on our homepage must be observed!**
- For the selection of metallic plaster profiles, please refer to the table for profile selection by mortar type, for the selection of plastering strips and plastering sealing strips, please refer to the corresponding selection tables by movement classes and areas of application in this catalogue, as well as the complete instructions for selection, processing and installation on our homepage.**

CORNER PROFILES

Corner bead for exterior render

Corner profile made of galvanised steel with PVC coating for interior and exterior plaster of 8 mm and thicker.

Colour: 10 - white

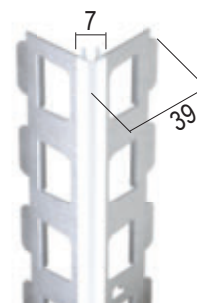

Item number	Plaster thickness (mm)	Length (cm)	Order number	Material	Package/ Large pack
1023	8 mm	250	100082	Galvanised steel, with PVC coating	15 PCS / 90 BUN
	8 mm	300	100084	Galvanised steel, with PVC coating	15 PCS / 90 BUN

Corner bead for interior plaster and exterior render

Corner profile made of galvanised steel with thicker zinc coating for increased protection against corrosion, for interior and exterior plaster of 10 mm and thicker.

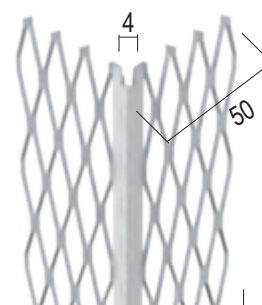

Item number	Plaster thickness (mm)	Length (cm)	Leg length	Order number	Material	Package/ Large pack
1085Z	10 mm	250	50 mm	100803	Galvanised steel	15 PCS / 42 BUN
	10 mm	300	50 mm	100811	Galvanised steel	15 PCS / 42 BUN
1045Z	12 mm	260	45 mm	113659	Galvanised steel	15 PCS / 42 BUN
	12 mm	300	45 mm	113658	Galvanised steel	15 PCS / 42 BUN
1043Z	15 mm	225	50 mm	108704	Galvanised steel	15 PCS / 48 BUN
	15 mm	250	50 mm	100508	Galvanised steel	15 PCS / 48 BUN
	15 mm	260	50 mm	103936	Galvanised steel	15 PCS / 48 BUN
	15 mm	275	50 mm	100520	Galvanised steel	15 PCS / 48 BUN
	15 mm	300	50 mm	100530	Galvanised steel	15 PCS / 48 BUN

Corner bead for exterior render

Corner profile made of galvanised steel with PVC coating with a narrow removal edge for interior and exterior plaster of 10 mm and thicker.

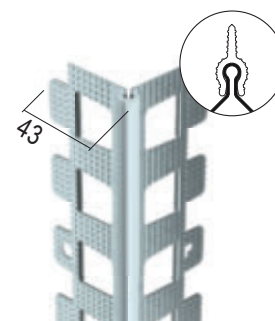

Item number	Plaster thickness (mm)	Length (cm)	Order number	Material	Package/ Large pack
1821	10 mm	225	117729	Galvanised steel, with PVC coating	15 PCS / 48 BUN
	10 mm	250	117730	Galvanised steel, with PVC coating	15 PCS / 48 BUN
	10 mm	260	117731	Galvanised steel, with PVC coating	15 PCS / 48 BUN
	10 mm	275	117732	Galvanised steel, with PVC coating	15 PCS / 48 BUN
	10 mm	300	117733	Galvanised steel, with PVC coating	15 PCS / 48 BUN
1824	14 mm	250	117734	Galvanised steel, with PVC coating	15 PCS / 56 BUN
	14 mm	260	117735	Galvanised steel, with PVC coating	15 PCS / 56 BUN
	14 mm	275	117736	Galvanised steel, with PVC coating	15 PCS / 56 BUN
	14 mm	300	117737	Galvanised steel, with PVC coating	15 PCS / 56 BUN

CORNER PROFILES

Corner bead for exterior render

Corner profile made of galvanised steel with PVC coating for various plaster thicknesses (a).

Colour: 10 - white

In the reveal area additionally for different plaster thicknesses variable applicable.

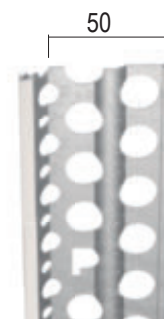

Item number	Plaster thickness (mm)	Length (cm)	Order number	Material	Package/ Large pack
1061	10 mm	250	100612	Galvanised steel, with PVC coating	15 PCS / 88 BUN
	10 mm	300	100625	Galvanised steel, with PVC coating	15 PCS / 88 BUN
1080	15 mm	300	100774	Galvanised steel, with PVC coating	15 PCS / 90 BUN
1062	20 mm	300	100646	Galvanised steel, with PVC coating	15 PCS / 64 BUN

Corner bead for exterior render

Corner profile made of galvanised steel with PVC coating for interior and exterior plaster of 10 mm and thicker.

Colour: 10 - white
Rounding off radius: 3,5 mm

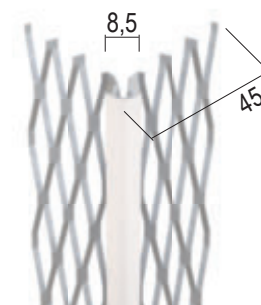

Item number	Plaster thickness (mm)	Length (cm)	Order number	Material	Package/ Large pack
1046	10 mm	225	105578	Galvanised steel, with PVC coating	15 PCS / 42 BUN
	10 mm	250	102534	Galvanised steel, with PVC coating	15 PCS / 42 BUN
	10 mm	300	102541	Galvanised steel, with PVC coating	15 PCS / 42 BUN

Corner bead for exterior plaster

Corner profile made of galvanised steel with PVC coating for interior and exterior plaster of 10 mm and thicker.

Colour: 10 - white
Rounding off radius: 4,25 mm

**POWER
GRIP**

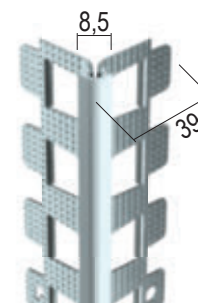

Item number	Plaster thickness (mm)	Length (cm)	Order number	Material	Package/ Large pack
1020	10 mm	225	117718	Galvanised steel, with PVC coating	15 PCS / 56 BUN
	10 mm	250	117719	Galvanised steel, with PVC coating	15 PCS / 56 BUN
	10 mm	250	117713	Galvanised steel, with PVC coating	15 PCS / 56 BUN
	10 mm	300	117722	Galvanised steel, with PVC coating	15 PCS / 56 BUN

Corner bead for exterior render

Corner profile made of galvanised steel with PVC coating for interior and exterior plaster of 12 mm and thicker.

Colour: 10 - white
Rounding off radius: 4 mm

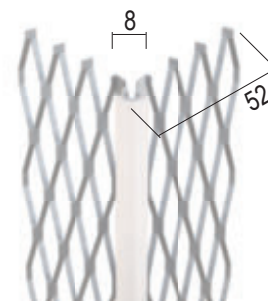

SALE

Item number	Plaster thickness (mm)	Length (cm)	Order number	Material	Package/ Large pack
1086	12 mm	300	100829	Galvanised steel, with PVC coating	15 PCS / 35 BUN

CORNER PROFILES

Corner bead for interior plaster and exterior render

Corner profile made of galvanised steel with thicker zinc coating for increased protection against corrosion, for interior and exterior plaster of 12 mm and thicker.

Aluminium version : 9112
Stainless steel version: 2212

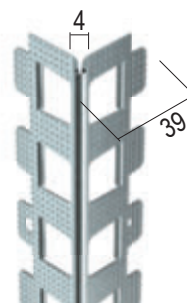

Item number	Plaster thickness (mm)	Length (cm)	Order number	Material	Package/ Large pack
1012Z	12 mm	225	117695	Galvanised steel	15 PCS / 72 BUN
	12 mm	250	117696	Galvanised steel	15 PCS / 72 BUN
	12 mm	275	117697	Galvanised steel	15 PCS / 72 BUN
	12 mm	300	117698	Galvanised steel	15 PCS / 72 BUN

Corner bead for interior plaster

Corner profile made of galvanised steel for interior and exterior plaster of 12 mm and thicker.

Notes:
 PowerGrip-surface embossing for improved plaster adhesion.

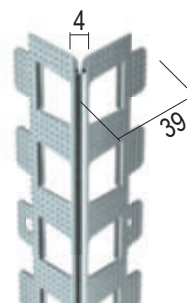

Item number	Plaster thickness (mm)	Length (cm)	Order number	Material	Package/ Large pack
1012Z	12 mm	225	119120	Galvanised steel	15 PCS / 72 BUN
	12 mm	250	119121	Galvanised steel	15 PCS / 72 BUN
	12 mm	275	119122	Galvanised steel	15 PCS / 72 BUN
	12 mm	300	119123	Galvanised steel	15 PCS / 72 BUN

Corner bead for interior plaster and exterior render

Corner profile made of galvanised steel with thicker zinc coating for increased protection against corrosion, for interior and exterior plaster of 14 mm and thicker.

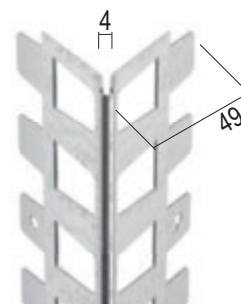

Item number	Plaster thickness (mm)	Length (cm)	Order number	Material	Package/ Large pack
1024Z	14 mm	250	100089	Galvanised steel	15 PCS / 40 BUN
	14 mm	300	100093	Galvanised steel	15 PCS / 40 BUN

CORNER PROFILES

Corner bead for exterior render

Corner profile made of galvanised steel with PVC coating for interior and exterior plaster of 14 mm and thicker.

Colour: 10 - white
Rounding off radius: 4 mm

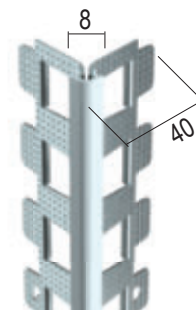

Item number	Plaster thickness (mm)	Length (cm)	Order number	Material	Package/ Large pack
1013	14 mm	200	117705	Galvanised steel, with PVC coating	15 PCS / 56 BUN
	14 mm	225	117706	Galvanised steel, with PVC coating	15 PCS / 56 BUN
	14 mm	250	117707	Galvanised steel, with PVC coating	15 PCS / 56 BUN
	14 mm	260	117708	Galvanised steel, with PVC coating	15 PCS / 56 BUN
	14 mm	275	117709	Galvanised steel, with PVC coating	15 PCS / 56 BUN
	14 mm	300	117710	Galvanised steel, with PVC coating	15 PCS / 56 BUN

Corner bead for interior plaster and exterior render

Corner profile with uneven flanges, made of galvanised steel with thicker zinc coating for increased protection against corrosion, for interior and exterior plaster of 15 mm and thicker.

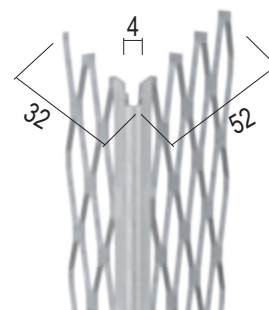

Item number	Plaster thickness (mm)	Length (cm)	Order number	Material	Package/ Large pack
SALE 1039Z	15 mm	260	100474	Galvanised steel	15 PCS / 64 BUN

Corner bead for exterior render

Corner profile made of galvanised steel with PVC coating for interior and exterior plaster of 15 mm and thicker.

Colour: 10 - white
Rounding off radius: 3,5 mm

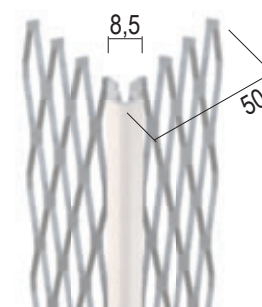

Item number	Plaster thickness (mm)	Length (cm)	Order number	Material	Package/ Large pack
1028	15 mm	250	100384	Galvanised steel, with PVC coating	15 PCS / 42 BUN
	15 mm	300	100400	Galvanised steel, with PVC coating	15 PCS / 42 BUN

Corner bead for exterior render

Corner profile made of galvanised steel with PVC coating for interior and exterior plaster of 20 mm and thicker.

Colour: 10 - white
Rounding off radius: 4,25 mm

Notes:
 Specially developed for schools and kindergartens. Satisfies the german guidelines and requirements of the statutory accident prevention regulations. See technical information.

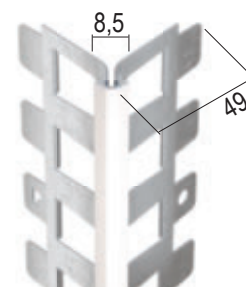

Item number	Plaster thickness (mm)	Length (cm)	Order number	Material	Package/ Large pack
1014	20 mm	250	100541	Galvanised steel, with PVC coating	15 PCS / 42 BUN
	20 mm	300	100552	Galvanised steel, with PVC coating	15 PCS / 42 BUN

PLASTER/RENDER STOPS

Stop profile for exterior render

Sliding joint profile made of galvanised steel with PVC coating for exterior plaster of 10 mm and thicker.

Colour: 10 - white

Notes:

Only to be installed vertically on damp or wet surfaces as well as exposed building elements.



Item number	Plaster thickness (mm)	Length (cm)	Order number	Material	Package/ Large pack
1224	10 mm	250	107487	Galvanised steel, with PVC coating	25 PCS / 50 BUN
	10 mm	300	107488	Galvanised steel, with PVC coating	25 PCS / 50 BUN
1223	14 mm	250	107380	Galvanised steel, with PVC coating	25 PCS / 49 BUN
	14 mm	300	107381	Galvanised steel, with PVC coating	25 PCS / 49 BUN
1222	20 mm	250	107471	Galvanised steel, with PVC coating	25 PCS / 42 BUN
	20 mm	300	107472	Galvanised steel, with PVC coating	25 PCS / 42 BUN

Stop profile roof for exterior render

Stop profiles made of galvanised steel provide a fix against roof planking between the rafters and provide DIN-conform roof ventilation.

Notes:

Ventilation cross section: 207 cm²/lfm.

Ventilation area: 207 cm²/lfm.

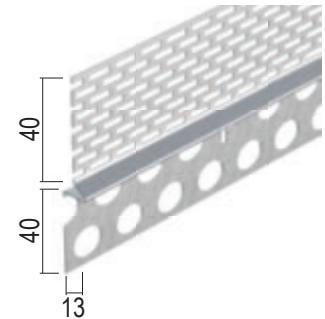

Item number	Plaster thickness (mm)	Length (cm)	Order number	Material	Package/ Large pack
1241	13 mm	250	100972	Galvanised steel	20 PCS / 84 BUN
1242	23 mm	250	100973	Galvanised steel	20 PCS / 91 BUN

BASE PROFILES

Base stop profile for exterior render

Base profile made of galvanised steel with PVC coating for exterior plaster of 10 mm and thicker.

Colour: 10 - white
Angular position: 110°

Item number	Plaster thickness (mm)	Length (cm)	Order number	Material	Package/ Large pack
1227	10 mm	250	107491	Galvanised steel, with PVC coating	25 PCS / 55 BUN
	10 mm	300	107492	Galvanised steel, with PVC coating	25 PCS / 55 BUN

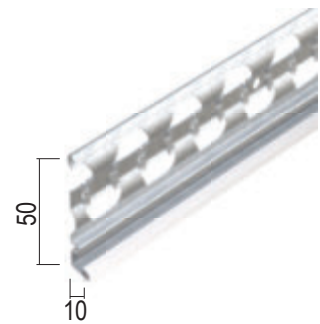

Base stop profile for exterior render

Base profile made of galvanised steel with PVC coating for exterior plaster of 14 mm and thicker.

Colour: 10 - white
Angular position: 110°

Item number	Plaster thickness (mm)	Length (cm)	Order number	Material	Package/ Large pack
1225	14 mm	250	107402	Galvanised steel, with PVC coating	25 PCS / 49 BUN
	14 mm	300	107403	Galvanised steel, with PVC coating	25 PCS / 49 BUN

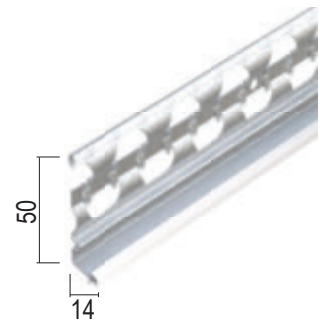

Base stop profile for exterior render

Base profile made of galvanised steel with PVC coating for exterior plaster of 20 mm and thicker.

Colour: 10 - white
Angular position: 110°

Item number	Plaster thickness (mm)	Length (cm)	Order number	Material	Package/ Large pack
1229	20 mm	250	107545	Galvanised steel, with PVC coating	25 PCS / 40 BUN
	20 mm	300	107546	Galvanised steel, with PVC coating	25 PCS / 40 BUN

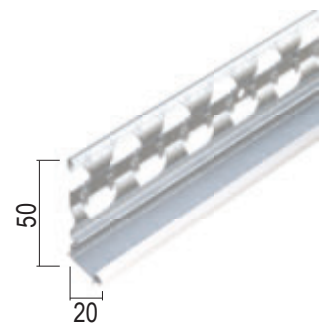

CONNECTING PROFILES

DIMPLED SHEET PROFILES

Dimpled sheet profile Universal - Base profile - Alu

Dimpled sheet profile universal - Base profile
made of aluminium
Also available as a Set 90535.

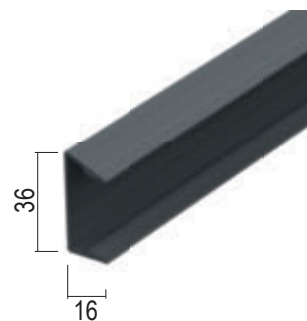

Item number	Length (cm)	Order number	Material	Package/ Large pack
90527	250	119860	Aluminum	5 PCS / 80 BUN

Dimpled sheet universel - Cover profile

Dimpled sheet profile universal - Cover profile
made of rigid PVC in anthracite.
Also available as a Set 90535.

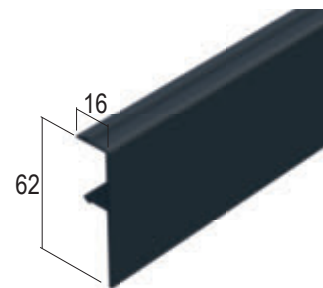

Item number	Length (cm)	Order number	Material	Colour	Package/ Large pack
37527	250	114202	PVC	91 - anthracite	10 PCS / 40 BOX

Dimpled sheet profile universal - Set Anthracite

Dimpled membrane profile universal - set
for 10 m dimpled membrane cover, consisting of:
4 basic profiles of 250 cm each made of aluminum
(90527) and 4 cover profiles of 250 cm each made
of PVC (37527).

Colour: 91 - anthracite

Notes:

Profile combination for 12,5 meters dimpled
sheet.

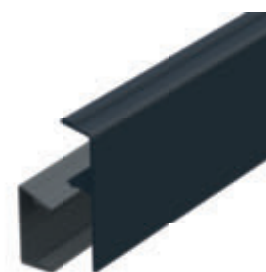

Item number	Length (cm)	Order number	Material	Package/ Large pack
90535	250	115584		1 PC / 49 BOX

Dimpled sheet profile

Convolute sheet/overhang profile made of stain-
less steel for interior and exterior plastering from
14 mm.

For the horizontal transition from the protective
layer (dimpled membrane, drainage mat, etc.) to
the base area. Also suitable for vertical and hori-
zontal use as an expansion joint/overhang profile.

Movement absorption tension/compression:
+/-10 mm

Notes:

Liability for coating adhesion on stainless steel
profiles is expressly excluded.

Color coating of our stainless steel profiles on
site is possible with suitable coatings. The
technical specifications in the coating
manufacturer's current data sheets must be
observed and, if necessary, test areas must be
created.

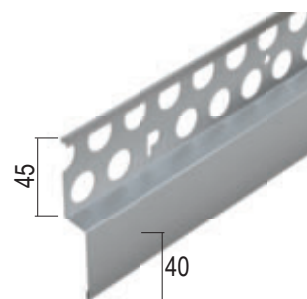

Item number	Plaster thickness (mm)	Length (cm)	Order number	Material	Package/ Large pack
2768	14 mm	250	115283	Stainless steel	10 PCS / 100 BUN

CONNECTING PROFILES

EXPANSION JOINT / OVERHANG PROFILES

Expansion joint profile for interior and exterior render

Expansion joint/overhang profile made of stainless steel for interior and exterior plastering from 14 mm.
Suitable for vertical and horizontal use.

Movement absorption tension/compression:
+/-10 mm

Notes:

See data sheet for possible profile combinations.
Liability for coating adhesion on stainless steel profiles is expressly excluded.
Color coating of our stainless steel profiles on site is possible with suitable coatings. The technical specifications in the coating manufacturer's current data sheets must be observed and, if necessary, test areas must be created.

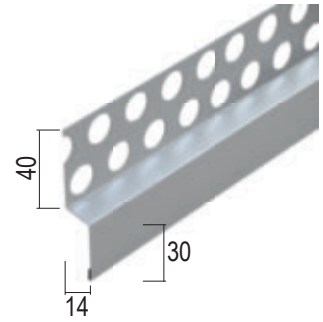

Item number	Plaster thickness (mm)	Length (cm)	Order number	Material	Package/ Large pack
2297	14 mm	250	114955	Stainless steel	25 PCS / 100 BUN
2299	20 mm	250	114956	Stainless steel	25 PCS / 100 BUN

Metal sheet connecting profile for exterior render

Plasterable metal connection profile made of stainless steel for exterior plaster of 18 mm and thicker.

Notes:

An additional reinforced plaster layer on the base render is recommended to increase the stability of the plaster layer.



Item number	Plaster thickness (mm)	Length (cm)	Order number	Material	Package/ Large pack
2765	18 mm	250	117190	Stainless steel	10 PCS / 49 BUN

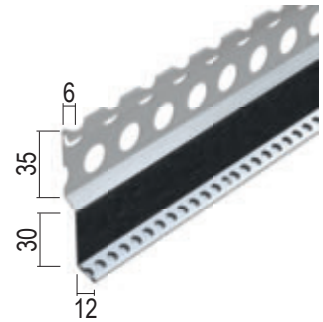

Metal sheet connecting profile for exterior render

Metal connection profile made of galvanised steel with PVC coating for exterior plaster of 20 mm and thicker.

Colour: 10 - white

Notes:

Suited for sheet thicknesses of approx. 0.8 - 1.0 mm.

Item number	Plaster thickness (mm)	Length (cm)	Order number	Material	Package/ Large pack
1765	20 mm	250	113726	Galvanised steel, with PVC coating	10 PCS / 80 BUN

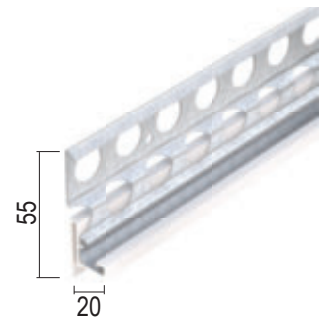

CONNECTING PROFILES

EXPANSION JOINT / OVERHANG PROFILES

Connecting profile for plaster and ceramic

Connecting profile made of stainless steel with a nosing of 20 mm for the horizontal transition of plaster surfaces to surfaces with ceramic coverings.

Notes:
 Liability for coating adhesion on stainless steel profiles is expressly excluded. Color coating of our stainless steel profiles on site is possible with suitable coatings. The technical specifications in the coating manufacturer's current data sheets must be observed and, if necessary, test areas must be created.

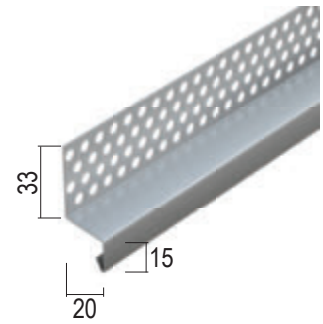

Item number	Length (cm)	Order number	Material	Package/ Large pack
2293	250	114417	Stainless steel	10 PCS / 80 BUN
2295	250	114418	Stainless steel	10 PCS / 80 BUN

CONNECTING PROFILES

CONNECTING PROFILES

Connection profile to roller shutter/venetian with mesh

Self-sticking connection profile of PVC with sewn alkali-resistant, coarse-meshed glass fibre mesh for plaster and WDVS, for producing connectors on roller shutter boxes with drip edge. For putting on to the border of the roller shutter box apron, additionally with self-sticking foam tape, close-celled, for optional glue mounting on thinner sheets.

Colour: 10 - white
Fabric dimension: 100 mm
Mesh size: 7 x 7 mm
Grammage: 160 g/m²
Notes: One-sided mesh-overhang of 10 cm at the end of the rod.

Item number	Plaster thickness (mm)	Length (cm)	Order number	Material	Package/ Large pack
37946	6 mm	250	114676	Rigid PVC with glass fibre mesh	25 PCS / 13 BOX

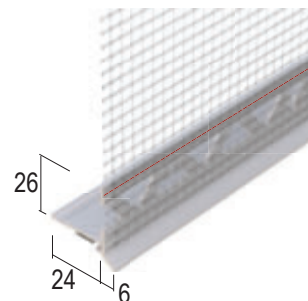

Connection profile to roller shutter/venetian with mesh

Self-sticking connection profile of PVC with sewn alkali-resistant, coarse-meshed glass fibre mesh for plaster and WDVS, for producing connectors on roller shutter boxes with drip edge. For putting on to the border of the roller shutter box apron, additionally with self-sticking foam tape, close-celled, for optional glue mounting on thinner sheets.

Colour: 10 - white
Fabric dimension: 100 mm
Mesh size: 7 x 7 mm
Grammage: 160 g/m²
Notes: One-sided mesh-overhang of 10 cm at the end of the rod.

Item number	Plaster thickness (mm)	Length (cm)	Order number	Material	Package/ Large pack
37428	6 mm	250	114675	Rigid PVC with glass fibre mesh	25 PCS / 13 BOX

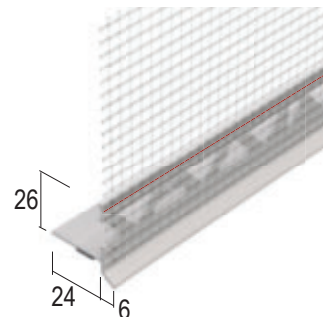

Connection profile to roller shutter/venetian with mesh

Connection profile of PVC with sewn alkali-resistant, coarse-meshed glass fibre mesh for plaster and WDVS, for producing connectors on roller shutter boxes with drip edge. For putting on to the border of the roller shutter box apron.

Colour: 10 - white
Fabric dimension: 100 mm
Mesh size: 7 x 7 mm
Grammage: 160 g/m²
Notes: One-sided mesh-overhang of 10 cm at the end of the rod.

Item number	Plaster thickness (mm)	Length (cm)	Order number	Material	Package/ Large pack
37429	6 mm	250	115769	Rigid PVC with glass fibre mesh	25 PCS / 13 BOX

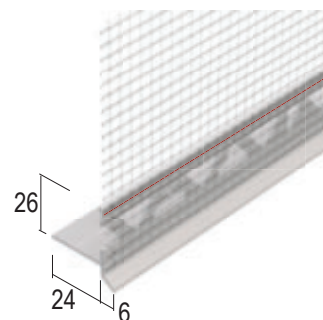

Attica profile for exterior render

White PVC stop profile for plaster thicknesses of 14 mm and greater. For all types of plaster and mortar. With a sealing edge to create precise flush and aligned on the edges of buildings.

Colour: 10 - white
Notes: Visible side in white, wings in grey.

Item number	Plaster thickness (mm)	Length (cm)	Order number	Material	Package/ Large pack
NEW 37214	14 mm	250	119310	Hard PVC	25 PCS / 20 BOX

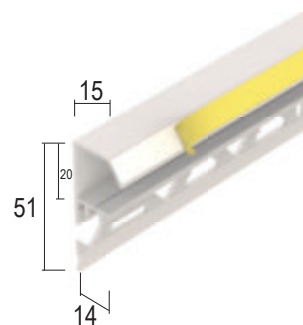

JOINT PROFILES

Sliding joint profile for exterior render

Sliding joint profile made of galvanised steel with PVC coating for interior and exterior plaster of 14 mm and thicker.

Colour: 10 - white

Notes:

The sliding joint profile is comprised of lower component 1240 and the upper base profile 1225.

Item number	Plaster thickness (mm)	Length (cm)	Order number	Material	Package/ Large pack
1240	14 mm	300	107608	Galvanised steel, with PVC coating	25 PCS / 40 BUN
	14 mm	250	107402	Galvanised steel, with PVC coating	25 PCS / 49 BUN
1225	14 mm	300	107403	Galvanised steel, with PVC coating	25 PCS / 49 BUN

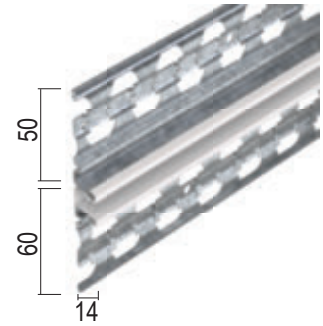

Sliding joint profile for exterior render

Sliding joint profile made of galvanised steel with PVC coating for interior and exterior plaster of 20 mm and thicker.

Colour: 10 - white

Notes:

The sliding joint profile is comprised of lower component 1226 and the upper base profile 1229.

Item number	Plaster thickness (mm)	Length (cm)	Order number	Material	Package/ Large pack
SALE 1226	20 mm	300	107470	Galvanised steel, with PVC coating	25 PCS / 56 BUN
1229	20 mm	250	107545	Galvanised steel, with PVC coating	25 PCS / 40 BUN
	20 mm	300	107546	Galvanised steel, with PVC coating	25 PCS / 40 BUN

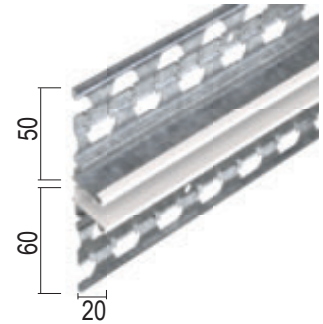

Bossprofile for interior plaster and exterior render

Boss aluminium profile with white base coat for interior and exterior plaster of 17 mm and thicker. **Colour: 10 - white**



Item number	Plaster thickness (mm)	Length (cm)	Order number	Material	Package/ Large pack
9293	17 mm	250	102139	Aluminum, with basic coating	20 PCS / 35 BUN

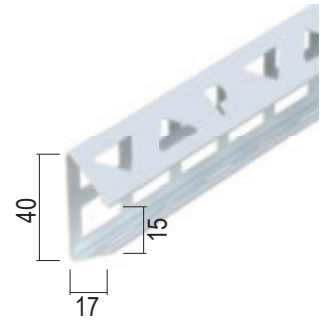

Bossprofile for interior plaster and exterior render

Boss aluminium profile with white base coat for interior and exterior plaster of 18.5 mm and thicker. **Colour: 10 - white**



Item number	Plaster thickness (mm)	Length (cm)	Order number	Material	Package/ Large pack
9294	18,5 mm	250	102141	Aluminum, with basic coating	20 PCS / 35 BUN

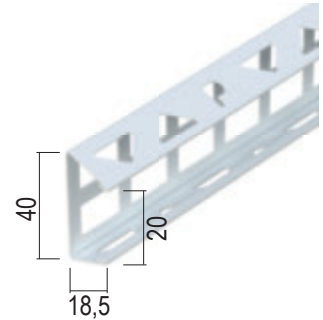

Bossprofile for interior plaster and exterior render

Boss aluminium profile with white base coat for interior and exterior plaster of 20 mm or more. **Colour: 10 - white**



Item number	Plaster thickness (mm)	Length (cm)	Order number	Material	Package/ Large pack
9295	20 mm	250	102143	Aluminum, with basic coating	20 PCS / 40 BUN

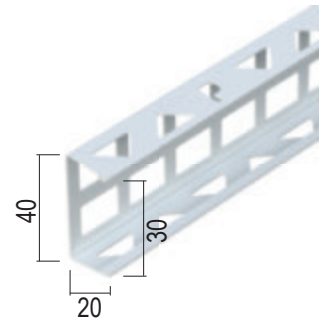

WIRED CORNER BEADS

Wired corner bead for interior plaster (IP)

Wire alignment bracket made of galvanised steel for interior and exterior plaster of 10 mm and thicker.



Item number	Plaster thickness (mm)	Length (cm)	Order number	Material	Package/ Large pack
1156	10 mm	250	108933	Galvanised steel	40 PCS / 48 BOX
	10 mm	295	102031	Galvanised steel	40 PCS / 48 BOX

Wired corner bead for interior and exterior plaster (AP)

Wire alignment bracket made of galvanised steel for interior and exterior plaster of 15 mm and thicker.

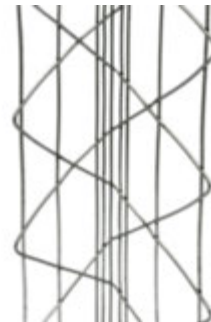

Item number	Plaster thickness (mm)	Length (cm)	Order number	Material	Package/ Large pack
11511	15 mm	260	115426	Galvanised steel	40 PCS / 56 BOX
	15 mm	275	115502	Galvanised steel	40 PCS / 56 BOX
	15 mm	295	115427	Galvanised steel	40 PCS / 56 BOX

Wired corner bead for interior and exterior plaster (APP)

Wire alignment bracket made of galvanised steel with white basecoat polyester coating for interior and exterior plaster of 15 mm and thicker.

Colour: 10 - white



Item number	Plaster thickness (mm)	Length (cm)	Order number	Material	Package/ Large pack
11571	15 mm	260	116290	Galvanised steel, with white basic coating	40 PCS / 56 BOX
	15 mm	295	116048	Galvanised steel, with white basic coating	40 PCS / 56 BOX

Wired corner bead for interior and exterior plaster (APS)

Wire alignment bracket made of galvanised steel for interior and exterior plaster of 15 mm and thicker.

Notes: Ideally suited for coarse-grained plaster when applying only two longitudinal wires.



Item number	Plaster thickness (mm)	Length (cm)	Order number	Material	Package/ Large pack
11541	15 mm	260	115424	Galvanised steel	40 PCS / 56 BOX
	15 mm	275	115503	Galvanised steel	40 PCS / 56 BOX
	15 mm	295	115425	Galvanised steel	40 PCS / 56 BOX

WIRED CORNER BEADS

Angle de redressement de fil pour extérieurs (APE)

Stainless steel wire alignment bracket for interior and exterior plasters of 15 mm and thicker.

Notes: Ideally suited for coarse-grained base plaster. Improved corrosion protection.
Processing instructions: Ideally suited for coarse-grained base plaster.



Item number	Plaster thickness (mm)	Length (cm)	Order number	Material	Package / Large pack
11521	15 mm	295	115513	Stainless steel	40 PCS / 56 BOX

Angle de redressement de fil pour extérieurs (APA)

Wire alignment bracket made of galvanised steel for interior and exterior plaster of 15 mm and thicker.

Item number	Plaster thickness (mm)	Length (cm)	Order number	Material	Package / Large pack
11531	15 mm	260	115514	Galvanised steel	40 PCS / 56 BOX
	15 mm	275	115515	Galvanised steel	40 PCS / 56 BOX
	15 mm	295	115516	Galvanised steel	40 PCS / 56 BOX

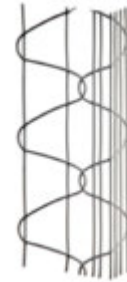

Wired corner bead for interior and exterior plaster (APPA)

Wire alignment bracket made of galvanised steel with white basecoat for interior and exterior plaster of 15 mm and thicker.

Colour: 10 - white

Item number	Plaster thickness (mm)	Length (cm)	Order number	Material	Package / Large pack
11551	15 mm	295	116047	Galvanised steel, with white basic coating	40 PCS / 56 BOX

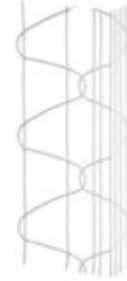

Wired corner bead for interior and exterior plaster (APR)

Wire alignment bracket made of galvanised steel specially designed for rounded edges on interior and exterior plaster of 15 mm and thicker.

Notes: Speziell entwickelt für Schulen und Kindergärten. Erfüllt die Richtlinien und Anforderungen der gesetzlichen Unfallverhütungsvorschriften (siehe Technik-Information).

Item number	Plaster thickness (mm)	Length (cm)	Order number	Material	Package / Large pack
11601	15 mm	295	115517	Galvanised steel	40 PCS / 56 BOX



WIRED CORNER BEADS

Wired corner bead for interior and exterior plaster (APB)

Wire alignment bracket made of galvanised steel for arched constructions with interior and exterior plaster of 15 mm and thicker.



Item number	Plaster thickness (mm)	Length (cm)	Order number	Material	Package/ Large pack
11581	15 mm	295	115518	Galvanised steel	40 PCS / 56 BOX

Wired corner bead for interior and exterior plaster (APK)

Wire alignment bracket made of galvanised steel with PVC edge for interior and exterior plaster of 15 mm and thicker.

Colour: 10 - white
Notes: Ideally suited for sgraffito.



Item number	Plaster thickness (mm)	Length (cm)	Order number	Material	Package/ Large pack
1161	15 mm	295	102045	Galvanised steel, with PVC coating	25 PCS / 30 BOX

Wired corner bead for interior and exterior plaster (APBK)

Wire alignment bracket made of galvanised steel with PVC edge for arched constructions with interior and exterior plaster of 15 mm and thicker.

Colour: 10 - white
Notes: Ideally suited for sgraffito.



Item number	Plaster thickness (mm)	Length (cm)	Order number	Material	Package/ Large pack
1159	15 mm	295	102038	Galvanised steel, with PVC coating	25 PCS / 30 BOX

REINFORCING MESH EXTERNAL RENDERING

Glass fibre mesh universal

Glass fibre mesh for thermal insulation. Fabric tested in accordance with ETAG 004, slide proof, free of plasticiser. Roll width 100 cm, 8 x 8 mm, 210g/m² bordeaux red.

Mesh size: 6 x 6 mm
Grammage: 105 g/m²



Item number	Fabric dimension	Order number	Material	Color	Package/ Large pack
14917	100 cm x 50 m	119798	Glass fiber	10 - white	50 M2 / 30 ROL
	100 cm x 100 m	119799	Glass fiber	10 - white	100 M2 / 15 ROL
	50 cm x 50 m	119800	Glass fiber	10 - white	25 M2 / 60 ROL
	50 cm x 100 m	119801	Glass fiber	10 - white	50 M2 / 30 ROL
	33 cm x 50 m	119802	Glass fiber	10 - white	17 M2 / 90 ROL
	33 cm x 100 m	119803	Glass fiber	10 - white	33 M2 / 45 ROL
	25 cm x 100 m	119804	Glass fiber	10 - white	25 M2 / 60 ROL
	20 cm x 50 m	119805	Glass fiber	10 - white	10 M2 / 150 ROL

Reinforcing mesh exterior plaster

Glass fibre mesh for thermal insulation. Fabric tested in accordance with ETAG 004, slide proof, free of plasticiser. Roll width 100 cm, 8 x 8 mm, 210g/m² bordeaux red.

Mesh size: 10 x 10 mm
Grammage: 140 g/m²

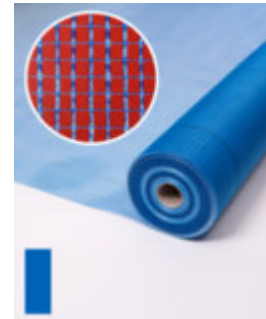

Item number	Fabric dimension	Order number	Material	Color	Package/ Large pack
14918	100 cm x 50 m	119806	Glass fiber	CD - blue	50 M2 / 24 ROL
	100 cm x 100 m	119807	Glass fiber	CD - blue	100 M2 / 12 ROL
	50 cm x 50 m	119808	Glass fiber	CD - blue	25 M2 / 48 ROL
	50 cm x 100 m	119809	Glass fiber	CD - blue	50 M2 / 24 ROL
	33 cm x 50 m	119810	Glass fiber	CD - blue	17 M2 / 72 ROL
	33 cm x 100 m	119811	Glass fiber	CD - blue	33 M2 / 36 ROL
	25 cm x 100 m	119812	Glass fiber	CD - blue	25 M2 / 48 ROL

Reinforcing mesh exterior plaster

Mesh for the reinforcement of base plasters in outdoor areas. Can be used for surface reinforcement and at transitions of e.g. wall connections, material changes, wall slots, roller shutter boxes, etc.

Mesh size: 10 x 10 mm
Grammage: 165 g/m²
Notes: Features: Alkali-resistant, displacement-resistant, plasticizer-free

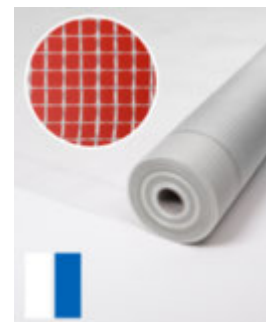

Item number	Fabric dimension	Order number	Material	Color	Package/ Large pack
14919	100 cm x 50 m	119813	Glass fiber	10 - white	50 M2 / 24 ROL
	100 cm x 100 m	119814	Glass fiber	10 - white	100 M2 / 12 ROL
	100 cm x 50 m	119815	Glass fiber	CD - blue	50 M2 / 24 ROL
	100 cm x 100 m	119816	Glass fiber	CD - blue	100 M2 / 12 ROL



GENERAL INFORMATION

- ▶ Wet rooms include domestic bathrooms, shower facilities, swimming pools, production areas, commercially used areas, including kitchens, etc. in which plaster and profiles are exposed to increased moisture. Only profiles with increased corrosion protection or made of corrosion-resistant material may be used there.
 - ▶ In DIN 18534, waterproofing of interiors, a distinction is made in Part 1 between different water impact classes:
 - ▶ W0-I – low water impact
 - ▶ W1-I – moderate water impact
 - ▶ W2-I – high water impact
 - ▶ W3-I – very high water impact
 - ▶ Our plaster profiles are therefore marked in this product area according to their suitability for these water impact classes:
 - ▶ For rooms with water impact classes W0-I to W2-I, plaster profiles made of aluminum with a white base coat can be used.
 - ▶ For rooms with water impact class W3-I, plaster profiles made of stainless steel must be used. Those can therefore be used for all water impact classes from W0-I to W3-I, provided that the profiles are covered by plaster, tiles or paint (exposed profiles require special care, see product information).
- ▶ Plaster profiles made of galvanized steel may only be used in Wet rooms if they are removed again after completion of the plastering.
- ▶ Cut metal profiles with hand shears. Never cut galvanized profiles with a cutting disc. Only process stainless steel profiles with rustproof tools and cut them with a cutting disc recommended for stainless steel.
- ▶ Remove any nails used for pre-fixing before plastering.
- ▶ In Wet rooms, attach the profiles with especially suitable mortar or with the plaster mortar to be used and align them flush and plumb.
- ▶ The heads of the plastering gauges must not protrude; re-smoothing may be necessary.
- ▶ The profile edge should remain visible or be covered, depending on the specification (single-layer or two-layer plaster).
- ▶ Clean flush metal parts, e.g. profile heads and PVC parts immediately after plastering.
- ▶ Ensure good ventilation after plastering.
- ▶ Store profiles in a dry place!

All standards and guidelines on the subject of plastering must be observed in their current version, in particular the following leaflets:

- Leaflet for the planning and application of metallic plaster profiles in external and internal areas from the European Association of Plaster Profile Manufacturers.
- Merkblatt Leaflet on plaster and drywall construction in Wet rooms with cladding made of ceramic tiles and boards or natural stone from the Finishing Division of the Central Association of the German Building Trade.

The product information as well as the additional information with the respective product illustrations in this catalogue and the further notes in our product data sheets and processing instructions on our homepage must be observed!



EDGE PROFILES CORROSION PROTECTION

Corner bead for interior plaster and exterior render

Stainless steel corner profile for filler and thin-layer plaster of 3 mm and thicker in interior or exterior areas. Suited for use in damp and wet areas.

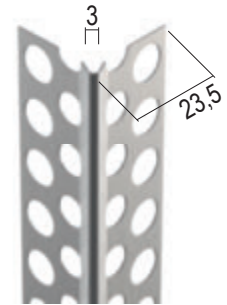

Item number	Plaster thickness (mm)	Length (cm)	Order number	Material	Package/ Large pack
2274	3 mm	250	107674	Stainless steel	25 PCS / 200 BUN

Corner bead for interior plaster and exterior render

Aluminium corner profile with white base coating for thin-layer plaster of 6 mm and thicker in interior or exterior areas.

Colour: 10 - white
Galvanised steel version : 1084

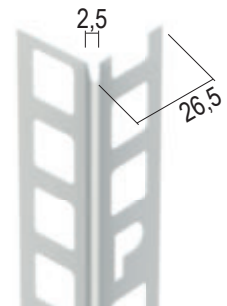

Item number	Plaster thickness (mm)	Length (cm)	Order number	Material	Package/ Large pack
9104	6 mm	250	107166	Aluminum, with basic coating	25 PCS / 88 BUN
	6 mm	300	107168	Aluminum, with basic coating	25 PCS / 88 BUN

Corner bead for interior plaster and exterior render

Aluminium corner profile with white base coat for interior and exterior plaster of 8 mm and thicker.

Colour: 10 - white
Galvanised steel version : 1026

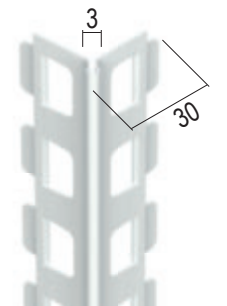

Item number	Plaster thickness (mm)	Length (cm)	Order number	Material	Package/ Large pack
9100	8 mm	260	108705	Aluminum, with basic coating	25 PCS / 56 BUN
	8 mm	275	112171	Aluminum, with basic coating	25 PCS / 56 BUN
	8 mm	300	108706	Aluminum, with basic coating	25 PCS / 56 BUN

Corner bead for interior plaster and exterior render

Stainless steel corner profile for interior and exterior plasters of 8 mm and thicker. Suited for use in damp and wet areas.

Rounding off radius: 4,75 mm

Notes:
Specially developed for schools and kindergartens. Satisfies the german guidelines and requirements of the statutory accident prevention regulations. See technical information.

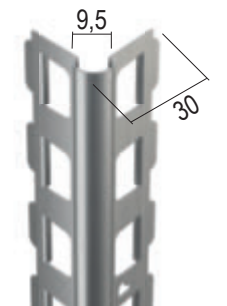

Item number	Plaster thickness (mm)	Length (cm)	Order number	Material	Package/ Large pack
2215	8 mm	260	108395	Stainless steel	25 PCS / 66 BUN

EDGE PROFILES CORROSION PROTECTION

Corner bead for interior plaster and exterior render

Stainless steel corner profile for interior and exterior plasters of 8 mm and thicker. Suited for use in damp and wet areas.

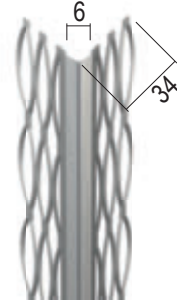

Item number	Plaster thickness (mm)	Length (cm)	Order number	Material	Package/ Large pack
2209	8 mm	250	101294	Stainless steel	25 PCS / 120 BUN

Corner bead for interior plaster and exterior render

Aluminium corner profile with white base coating, for interior plaster with various plaster thicknesses.

Colour: 10 - white

Stainless steel version: 2251

Notes:

In the reveal area additionally for different plaster thicknesses variable applicable.



Item number	Plaster thickness (mm)	Length (cm)	Order number	Material	Package/ Large pack
91051	9 mm	270	110603	Aluminum, with basic coating	15 PCS / 100 BUN

Corner bead for interior and exterior plaster

Stainless steel corner profile, for interior and exterior plaster with various plaster thicknesses, e.g., in the soffit area.

Notes:

In the reveal area additionally for different plaster thicknesses variable applicable.



Item number	Plaster thickness (mm)	Length (cm)	Order number	Material	Package/ Large pack
2251	9 mm	300	101369	Stainless steel	15 PCS / 88 BUN

Corner bead for interior and exterior plaster

Stainless steel corner profile for interior and exterior plasters of 10 mm and thicker. Suited for use in damp and wet areas.

Rounding off radius: 2,5 mm

Notes:

Specially developed for schools and kindergartens. Satisfies the german guidelines and requirements of the statutory accident prevention regulations. See technical information.

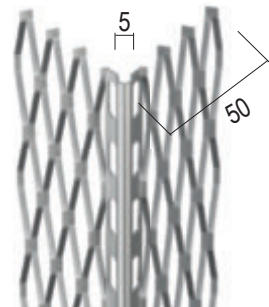

Item number	Plaster thickness (mm)	Length (cm)	Order number	Material	Package/ Large pack
7476	10 mm	300	102499	Stainless steel	25 PCS / 36 BOX

EDGE PROFILES CORROSION PROTECTION

Corner bead for interior plaster and exterior render

Stainless steel corner profile for interior and exterior plasters of 10 mm and thicker. Suited for use in damp and wet areas.

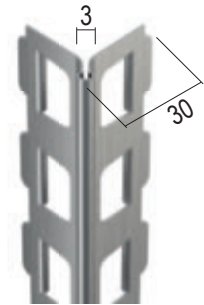

Item number	Plaster thickness (mm)	Length (cm)	Order number	Material	Package/ Large pack
2218	10 mm	250	101324	Stainless steel	25 PCS / 66 BUN
	10 mm	260	107749	Stainless steel	25 PCS / 66 BUN
	10 mm	300	103034	Stainless steel	25 PCS / 66 BUN

Corner bead for interior plaster and exterior render

Aluminium corner profile with white base coating for interior and exterior plaster of 10 mm and thicker.

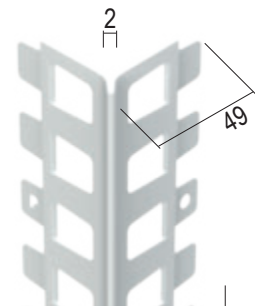

Item number	Plaster thickness (mm)	Length (cm)	Order number	Material	Package/ Large pack
91081	10 mm	260	108707	Aluminum, with basic coating	20 PCS / 24 BOX
	10 mm	300	106507	Aluminum, with basic coating	20 PCS / 24 BOX

Corner bead for interior plaster and exterior render

Aluminium corner profile with white base coat for interior and exterior plaster of 10 mm and thicker.

Colour: 10 - white
Rounding off radius: 12,5 mm

Notes: Specially developed for schools and kindergartens. Satisfies the german guidelines and requirements of the statutory accident prevention regulations. See technical information.

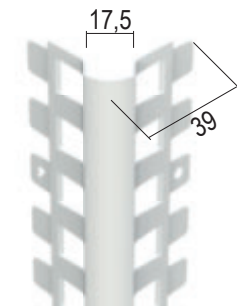

Item number	Plaster thickness (mm)	Length (cm)	Order number	Material	Package/ Large pack
9571	10 mm	260	106562	Aluminum, with basic coating	15 PCS / 30 BOX

Corner bead for interior plaster and exterior render

Aluminium corner profile with white base coating for interior and exterior plaster of 12 mm and thicker.

Colour: 10 - white

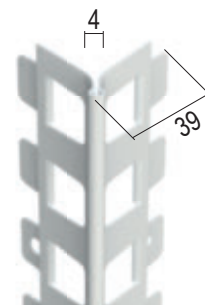

Item number	Plaster thickness (mm)	Length (cm)	Order number	Material	Package/ Large pack
9112	12 mm	225	108643	Aluminum, with basic coating	15 PCS / 72 BUN
	12 mm	260	107282	Aluminum, with basic coating	15 PCS / 72 BUN
	12 mm	275	112172	Aluminum, with basic coating	15 PCS / 72 BUN
	12 mm	300	107179	Aluminum, with basic coating	15 PCS / 72 BUN
9134	14 mm	300	107066	Aluminum, with basic coating	15 PCS / 42 BUN

EDGE PROFILES CORROSION PROTECTION

Corner bead for interior plaster and exterior render

Edge profile made of aluminium with white priming coat, for interior and exterior plaster from 12 mm.

Notes:
Optimized hole pattern as well as optimized perforation of the profile head.

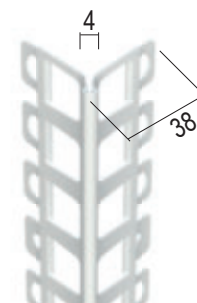

Item number	Plaster thickness (mm)	Length (cm)	Order number	Material	Package/ Large pack
9113	12 mm	260	114497	Aluminum, with basic coating	15 PCS / 72 BUN
	12 mm	275	117236	Aluminum, with basic coating	15 PCS / 72 BUN
	12 mm	300	114499	Aluminum, with basic coating	15 PCS / 72 BUN

Corner bead for interior plaster and exterior render

Stainless steel corner profile for interior and exterior plasters of 12 mm and thicker. Suited for use in damp and wet areas.

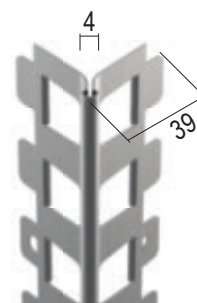

Item number	Plaster thickness (mm)	Length (cm)	Order number	Material	Package/ Large pack
2212	12 mm	300	105875	Stainless steel	15 PCS / 72 BUN

Corner bead for interior plaster and exterior render

Corner protection beads for interior plaster can be used in damp or wet rooms, or for exterior plaster.

Rounding off radius: 2,5 mm

Notes:
Specially developed for schools and kindergartens. Satisfies the german guidelines and requirements of the statutory accident prevention regulations. See technical information.

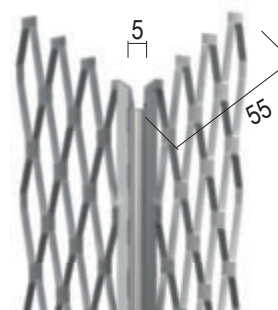

Item number	Plaster thickness (mm)	Length (cm)	Order number	Material	Package/ Large pack
7478	15 mm	250	113769	Stainless steel	25 PCS / 24 BUN
	15 mm	300	113768	Stainless steel	25 PCS / 24 BUN
7483	20 mm	300	102500	Stainless steel	25 PCS / 24 BOX

PLASTER GAUGES CORROSION PROTECTION

Depth gauge profile for interior plaster

Stainless steel plaster depth gauge profile for interior plasters of 6 mm and thicker.



Item number	Plaster thickness (mm)	Length (cm)	Order number	Material	Package/ Large pack
2206	6 mm	260	111975	Stainless steel	50 PCS / 100 BUN
	6 mm	300	111976	Stainless steel	50 PCS / 100 BUN
2205	10 mm	260	111973	Stainless steel	50 PCS / 64 BUN
	10 mm	300	111974	Stainless steel	50 PCS / 64 BUN

Depth gauge profile for interior plaster

Aluminium depth gauge profile with white base coating for interior plaster of 6 mm and thicker.

Colour: 10 - white
Stainless steel version: 2206



Item number	Plaster thickness (mm)	Length (cm)	Order number	Material	Package/ Large pack
9003	6 mm	260	111977	Aluminum, with basic coating	50 PCS / 100 BUN
	6 mm	300	111978	Aluminum, with basic coating	50 PCS / 100 BUN
	10 mm	260	111979	Aluminum, with basic coating	50 PCS / 64 BUN
9005	10 mm	275	111980	Aluminum, with basic coating	50 PCS / 64 BUN
	10 mm	300	111981	Aluminum, with basic coating	50 PCS / 64 BUN

Depth gauge profile for interior plaster

Aluminium depth gauge profile with white base coating for interior plaster of 8 mm and thicker.

Colour: 10 - white
Stainless steel version: 2208



Item number	Plaster thickness (mm)	Length (cm)	Order number	Material	Package/ Large pack
9008	8 mm	260	111994	Aluminum, with basic coating	50 PCS / 100 BUN
	8 mm	275	112166	Aluminum, with basic coating	50 PCS / 100 BUN

Depth gauge profile for interior plaster

Stainless steel plaster depth gauge profile for interior plasters of 8 mm and thicker.



Item number	Plaster thickness (mm)	Length (cm)	Order number	Material	Package/ Large pack
2208	8 mm	260	111993	Stainless steel	50 PCS / 100 BUN

PLASTER STOPS CORROSION PROTECTION

Stop profile for interior plaster and exterior render

Stainless steel corner profile for filler and thin-layer plaster of 3 mm and thicker in interior or exterior areas. Suited for use in damp and wet areas.

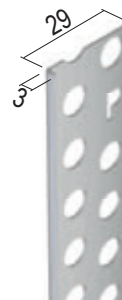

Item number	Plaster thickness (mm)	Length (cm)	Order number	Material	Package/ Large pack
2136	3 mm	250	101351	Stainless steel	25 PCS / 220 BUN
	3 mm	260	117860	Stainless steel	25 PCS / 220 BUN
	3 mm	300	117861	Stainless steel	25 PCS / 220 BUN

Stop profile for interior plaster and exterior render

Aluminium plaster stop profile with white base coating for interior and exterior plasters of 6 mm and thicker.

Colour: 10 - white

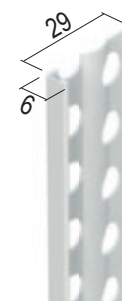

Item number	Plaster thickness (mm)	Length (cm)	Order number	Material	Package/ Large pack
9123	6 mm	250	116354	Aluminum, with basic coating	25 PCS / 224 BUN
	6 mm	300	116355	Aluminum, with basic coating	25 PCS / 224 BUN

Stop profile for interior plaster and exterior render

Stainless steel plaster stop profile for interior and exterior plasters of 6 mm and thicker. Suited for use in damp and wet areas.

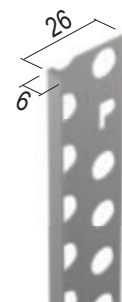

Item number	Plaster thickness (mm)	Length (cm)	Order number	Material	Package/ Large pack
2135	6 mm	250	101345	Stainless steel	25 PCS / 220 BUN
	6 mm	260	117862	Stainless steel	25 PCS / 220 BUN
	6 mm	300	117863	Stainless steel	25 PCS / 220 BUN

Stop profile for interior plaster and exterior render

Stop profile of stainless steel for interior and exterior plaster 8,5 mm and tile thicknesses up to 8 mm.



Item number	Plaster thickness (mm)	Length (cm)	Order number	Material	Package/ Large pack
2178	8,5 mm	250	101246	Stainless steel	20 PCS / 250 BUN
	8,5 mm	300	118468	Stainless steel	20 PCS / 250 BUN
2180	10,5 mm	250	101247	Stainless steel	20 PCS / 240 BUN
	10,5 mm	260	118469	Stainless steel	20 PCS / 240 BUN
2182	10,5 mm	300	118470	Stainless steel	20 PCS / 240 BUN
	12,5 mm	250	101249	Stainless steel	20 PCS / 234 BUN
2231	12,5 mm	300	118471	Stainless steel	20 PCS / 234 BUN
	14 mm	250	101339	Stainless steel	25 PCS / 150 BUN
2232	14 mm	300	101344	Stainless steel	25 PCS / 150 BUN
	16,5 mm	300	101355	Stainless steel	25 PCS / 150 BUN

PLASTER STOPS CORROSION PROTECTION

Stop profile for interior plaster and exterior render

Aluminium plaster stop profile with white base coating for interior and exterior plasters of 10 mm and thicker.

Colour: 10 - white
Stainless steel version: 2178

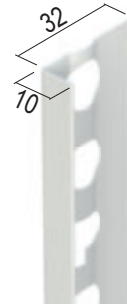

Item number	Plaster thickness (mm)	Length (cm)	Order number	Material	Package/ Large pack
9111	10 mm	250	107584	Aluminum, with basic coating	25 PCS / 144 BUN
	10 mm	300	108637	Aluminum, with basic coating	25 PCS / 144 BUN
9110	14 mm	250	107366	Aluminum, with basic coating	25 PCS / 120 BUN

Stop profile for interior plaster and exterior render

Stainless steel plaster stop profile for interior and exterior plasters of 20 mm and thicker and tile thicknesses up to 19.5 mm.

Angular position: 90°

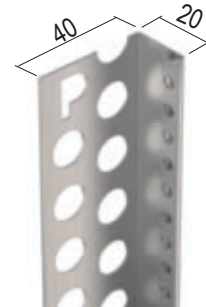

Item number	Plaster thickness (mm)	Length (cm)	Order number	Material	Package/ Large pack
2233	20 mm	300	101363	Stainless steel	25 PCS / 120 BUN

BASE PROFILES CORROSION PROTECTION

Base stop profile for interior plaster and exterior render

Stainless steel corner profile for interior and exterior plasters of 8 mm and thicker.

Angular position: 110°



Item number	Plaster thickness (mm)	Length (cm)	Order number	Material	Package/ Large pack
2184	8 mm	250	102501	Stainless steel	20 PCS / 200 BUN

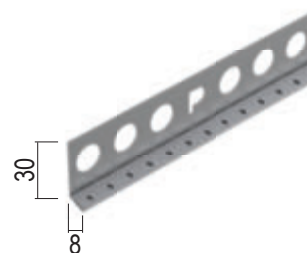

Base stop profile for interior plaster and exterior render

Stainless steel corner profile for interior and exterior plasters of 12 mm and thicker.

Angular position: 110°



Item number	Plaster thickness (mm)	Length (cm)	Order number	Material	Package/ Large pack
2225	12 mm	300	101331	Stainless steel	25 PCS / 56 BUN

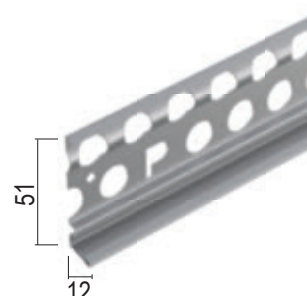

Base stop profile for interior plaster and exterior render

Aluminium base profile with white base coating for interior and exterior plasters of 12 mm and thicker.

Colour: 10 - white

Angular position: 110°

Stainless steel version: 2225



Item number	Plaster thickness (mm)	Length (cm)	Order number	Material	Package/ Large pack
9125	12 mm	300	107180	Aluminum, with basic coating	25 PCS / 48 BUN

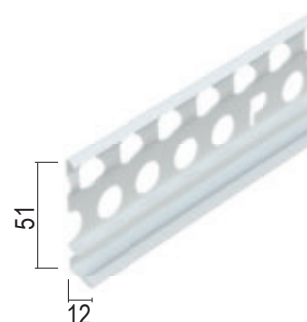

Base stop profile for interior plaster and exterior render

Stainless steel corner profile for interior and exterior plasters of 15 mm and thicker.

Angular position: 110°



Item number	Plaster thickness (mm)	Length (cm)	Order number	Material	Package/ Large pack
2229	15 mm	300	101335	Stainless steel	25 PCS / 48 BUN

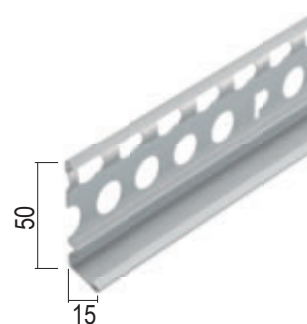

Base stop profile for interior plaster and exterior render

Base stop profile for exterior render 15mm, Aluminium-white primed.

Angular position: 110°



Item number	Plaster thickness (mm)	Length (cm)	Order number	Material	Package/ Large pack
9229	15 mm	300	119195	Aluminum, with basic coating	25 PCS / 48 BUN

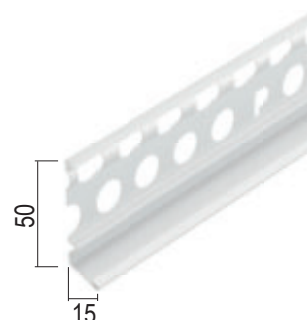

BASE PROFILES CORROSION PROTECTION

Base stop profile for interior plaster and exterior render

Stainless steel corner profile
for interior and exterior plasters of 20 mm and
thicker.

Angular position: 105°



Item number	Plaster thickness (mm)	Length (cm)	Order number	Material	Package/ Large pack
2230	20 mm	300	108910	Stainless steel	25 PCS / 120 BUN

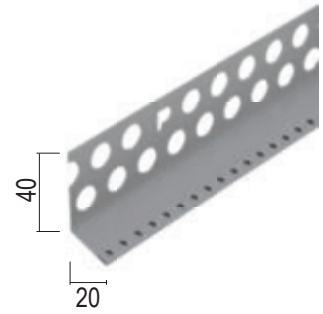

PVC PROFILES

Y-Corner bead for interior plaster and exterior render

PVC corner profile for plaster thicknesses of 6 mm and greater. For all types of plaster and mortar. With a sealing edge to create precise flush and aligned on the edges of buildings.

Colour: 10 - white

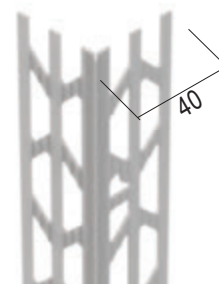

Item number	Plaster thickness (mm)	Length (cm)	Order number	Material	Package/ Large pack
38406	6 mm	260	118548	Hard PVC	20 PCS / 15 BOX
	6 mm	300	117890	Hard PVC	20 PCS / 15 BOX
38408	8 mm	260	118549	Hard PVC	20 PCS / 15 BOX
	8 mm	300	117893	Hard PVC	20 PCS / 15 BOX

Y-Corner bead for interior plaster and exterior render

PVC corner profile for plaster thicknesses of 6 mm and greater. For all types of plaster and mortar. With a sealing edge to create precise flush and aligned on the edges of buildings.

Colour: 10 - white

Notes:
Nose in white, wings in grey.

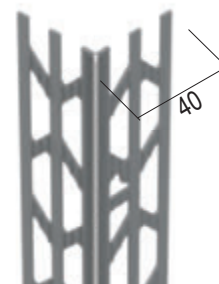

NEW

Item number	Plaster thickness (mm)	Length (cm)	Order number	Material	Package/ Large pack
37406	6 mm	260	118545	Hard PVC	20 PCS / 15 BOX
	6 mm	300	117869	Hard PVC	20 PCS / 15 BOX
37408	8 mm	260	118546	Hard PVC	20 PCS / 15 BOX
	8 mm	300	117872	Hard PVC	20 PCS / 15 BOX

NEW

Y-Corner bead for interior plaster and exterior render

PVC corner profile for plaster thicknesses of 10 mm and greater. For all types of plaster and mortar. With a sealing edge to create precise flush and aligned on the edges of buildings.

Colour: 10 - white

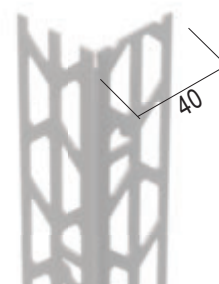

NEW

Item number	Plaster thickness (mm)	Length (cm)	Order number	Material	Package/ Large pack
38410	10 mm	260	118550	Hard PVC	20 PCS / 15 BOX
	10 mm	300	117895	Hard PVC	20 PCS / 15 BOX
38414	14 mm	260	118551	Hard PVC	20 PCS / 15 BOX
	14 mm	300	117897	Hard PVC	20 PCS / 15 BOX

Y-Corner bead for interior and exterior plaster

PVC corner profile for plaster thicknesses of 10 mm and greater. For all types of plaster and mortar. With a sealing edge to create precise flush and aligned on the edges of buildings.

Colour: 10 - white

Notes:
Nose in white, wings in grey.
Other colors on request.

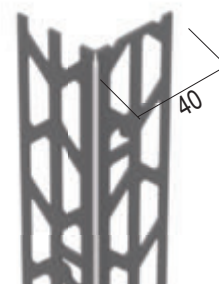

NEW

Item number	Plaster thickness (mm)	Length (cm)	Order number	Material	Package/ Large pack
37410	10 mm	260	118544	Hard PVC	20 PCS / 15 BOX
	10 mm	300	117876	Hard PVC	20 PCS / 15 BOX
37414	14 mm	260	118547	Hard PVC	20 PCS / 15 BOX
	14 mm	300	117881	Hard PVC	20 PCS / 15 BOX

NEW

Y-Corner bead for interior plaster and exterior render

Asymmetrical PVC corner profile for plaster thicknesses of 10 mm and greater. For all types of plaster and mortar. With a sealing edge to create precise flush and aligned on the edges of buildings.

Colour: 10 - white

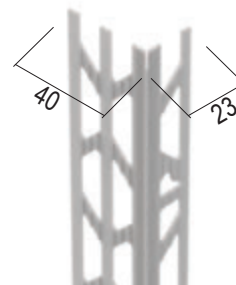

NEW

Item number	Plaster thickness (mm)	Length (cm)	Order number	Material	Package/ Large pack
38510	10 mm	260	118552	Hard PVC	20 PCS / 15 BOX
	10 mm	300	117899	Hard PVC	20 PCS / 15 BOX
38514	14 mm	260	118553	Hard PVC	20 PCS / 15 BOX
	14 mm	300	117901	Hard PVC	20 PCS / 15 BOX

NEW

Stop profile for interior and exterior render

Plaster stop profile made of PVC for interior and exterior plaster from 3 mm.

Colour: 10 - white



Item number	Plaster thickness (mm)	Length (cm)	Order number	Material	Package/ Large pack
37921	3 mm	250	115445	Hard PVC	50 PCS / 64 BOX
37922	6 mm	250	116015	Hard PVC	50 PCS / 64 BOX
37923	8 mm	250	116016	Hard PVC	50 PCS / 64 BOX
37924	10 mm	250	116017	Hard PVC	50 PCS / 64 BOX
37925	14 mm	250	116018	Hard PVC	50 PCS / 64 BOX

Stop profile for interior plaster and exterior render

White PVC stop profile for plaster thicknesses of 6 mm and greater. For all types of plaster and mortar. For creating precise flush and aligned on the edges of buildings.

Colour: 10 - white

Notes:
Visible side in white, wings in grey.

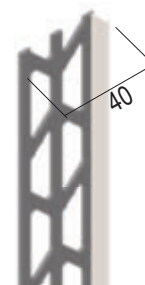

Item number	Plaster thickness (mm)	Length (cm)	Order number	Material	Package/ Large pack
37420	6 mm	250	117882	Hard PVC	25 PCS / 64 BOX
37422	10 mm	250	117884	Hard PVC	25 PCS / 64 BOX
37424	14 mm	250	117886	Hard PVC	25 PCS / 64 BOX

Base stop profile for interior plaster and exterior render

White PVC base profile for plaster thicknesses of 6,0 mm and greater. For all types of plaster and mortar. With an inside angle of 110°. For creating precise flush and aligned on the edges of buildings.

Colour: 10 - white

Angular position: 110°

Notes:
Visible side in white, wings in grey.

Item number	Plaster thickness (mm)	Length (cm)	Order number	Material	Package/ Large pack
37430	6 mm	250	117883	Hard PVC	25 PCS / 64 BOX
37432	10 mm	250	117887	Hard PVC	25 PCS / 64 BOX
37434	14 mm	250	117888	Hard PVC	25 PCS / 64 BOX

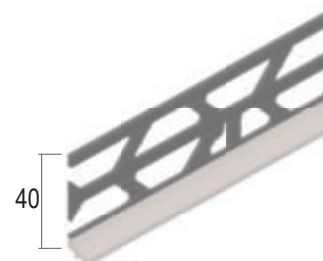

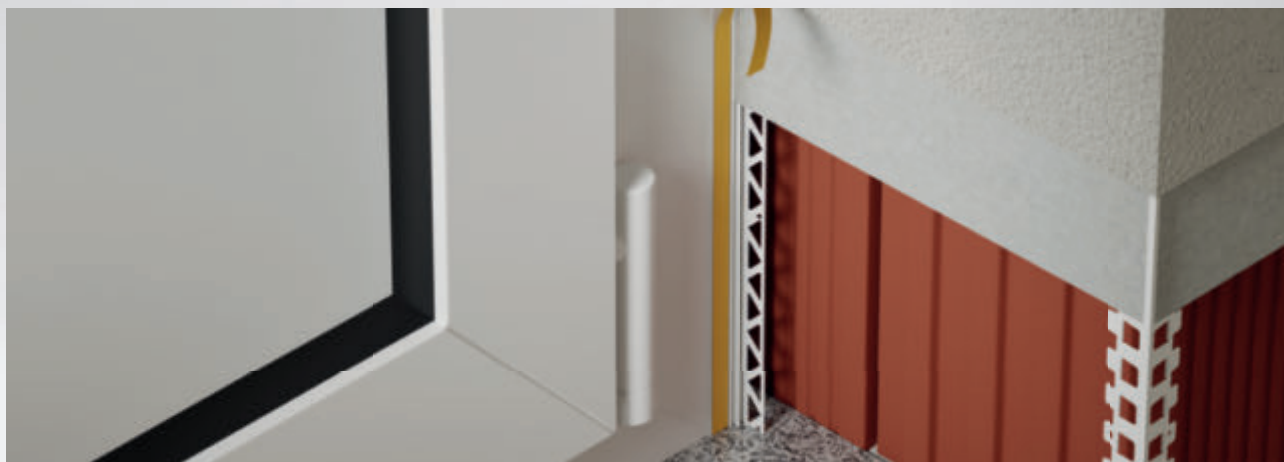

GENERAL INFORMATION

- ▶ Protektor offers plastering beads and plaster sealing beads in various designs for a secure, durable and visually clean connection of windows, doors and other components to plaster and external thermal insulation composite systems. They fulfil the function of a pulling aid for the plaster, sealing the connection and absorbing movements.
 - ▶ They consist of a PVC profile body, a tear-off adhesive flap (tear-off flap) and a self-adhesive, closed-cell foam tape. Protektor plastering strips have a U-shaped profile body to accommodate the plastering system. Protektor plaster sealing strips also have a plaster leg for optimum plaster adhesion and, especially for use in thermal insulation composite systems, an additional strip of alkali-resistant glass fibre fabric (in accordance with ETAG 004).
 - ▶ All Protektor plastering strips and plaster sealing strips are tested and classified in the movement classes in accordance with the VDPM data sheet and the SAF guideline (see below). Corresponding test certificates are available at www.protektor.de.
 - ▶ The selection of suitable Protektor plastering beads or plaster sealing beads for thermal insulation composite systems, exterior and interior plasters depends on the installation situation and size of windows and doors as well as the required movement class in the connection area in order to permanently ensure the required protection against driving rain. The selection tables on the following two pages allow for easy product selection.
 - ▶ When connecting to roller shutter guide rails, ensure that the rail itself is sufficiently fixed and secured. We generally recommend our Protektor ProLine membrane plaster sealing strips. Plastering strips without plaster legs are generally not suitable as connections on roller shutter guide rails
 - ▶ Cut PVC profiles to the required installation dimensions using suitable PVC scissors (e.g. Protektor profile scissors).
 - ▶ Plastering strips/plaster sealing strips with self-adhesive foam tape are glued plumb and level to the substrate and pressed down firmly. The bonding area must generally be dry, clean, free of frost, dust and grease and sufficiently load-bearing. A bonding test must always be carried out to assess the suitability of the adhesive.
 - ▶ Extending plastering strips without plaster legs by butting is not permitted. When butt-joining plaster sealing strips (with plaster legs), the joint must generally be positioned in the upper third of the reveal. Profile and mitre joints must be backed with Compriband.
 - ▶ To make it easier to remove the tear-off strip later, it is recommended to remove it approx. 1 to 2 cm wide in the area of the connection before setting the plastering bead or plaster sealing bead.
 - ▶ The permissible air and component temperature during application is between +5°C and +40°C.
 - ▶ Existing plaster strips must be completely backfilled and covered. Do not plaster or paint over the visible PVC strip, clean immediately after plastering.
 - ▶ The tear-off adhesive flap for attaching a protective film should only be removed after the final coat has been applied.
 - ▶ Store all profiles in a dry place! PVC profiles should also be stored in a cool, frost-free, horizontal and flat place.
- The regulations, recommendations and system approvals of the render and system manufacturers and the other trades involved in the construction work must always be observed. In addition, all standards and guidelines on the subject of rendering and ETICS in their current version must be observed, in particular DIN 55699, Ö-Norm B6400 and the guidelines and leaflets of the associations:
- Information sheet „Formation of details with profiles and joint sealing tapes for external rendering and ETICS“ from the Association for Insulation Systems, Render and Mortar (VDPM)
 - Guideline „Connections to windows and roller shutters with plaster, external thermal insulation composite systems and drywall construction“ from the Fachverband der Stuckateure für Ausbau und Fassade Baden-Württemberg (SAF), the Fachverband Glas, Fenster, Fassade Baden-Württemberg and the Bundesverband Rollläden + Sonnenschutz e. V.
 - „Processing guidelines for plastering and finishing profiles“ from the Austrian Plastering Working Group (ÖAP)
 - „Processing guideline for external thermal insulation composite systems“ of the Austrian Quality Group for Thermal Insulation Systems (QG)
- The product information as well as the additional information in the respective product illustrations in this catalogue and the further information in our product data sheets and processing instructions on our website must be observed! When selecting plastering strips and plaster sealing strips, please refer to the corresponding selection tables in this catalogue according to movement classes and areas of application, as well as the complete information on selection, processing and installation on our website.**

PROFILE SELECTION

PLASTER- AND PLASTER SEALING BORDERS



Classification of motion absorption capacity according to VPDM leaflet/SAF guideline

Movement class	A	B	C	D	E
Stretch	≥ 3,5 mm	≥ 3 mm	≥ 2 mm	≥ 1 mm	No requirement for motion absorption
Compression	≥ 2 mm	≥ 1,5 mm	≥ 1,5 mm	≥ 1 mm	
Shear transverse (both sides)	≥ 2 mm	≥ 1,5 mm	≥ 1 mm	≥ 1 mm	
Shear longitudinal (both sides)	≥ 2 mm	≥ 1,5 mm	≥ 1 mm	≥ 1 mm	

Position in relation to masonry	centered			flush	orset
external rendering					
	Window/door size	≤ 2,6m ²	≤ 6m ²	≤ 10m ²	
Movement class Connection ²⁾	Class D	Class C	Class B		
Art.Nr.	Profile Width				

Standard plastering borders in U-shape

37103	6 mm	✓ ¹⁾		
37104	9 mm	✓ ¹⁾		
3711 Neu	10 mm	✓ ¹⁾	✓ ¹⁾	
37111	6 mm	✓ ¹⁾	✓ ¹⁾	
3712 / 37129	10 mm	✓ ¹⁾	✓ ¹⁾	

Standard plastering borders in U-shape with hollow chamber

3726 Neu	9 mm	✓ ¹⁾	✓ ¹⁾	
3727	12 mm	✓ ¹⁾	✓ ¹⁾	

BasicLine Plaster sealing borders with perforated plaster leg

37606 / 37806	6 mm	✓	✓	
37609 / 37809	9 mm	✓	✓	
37706 / 37906	6 mm	✓	✓	
37709 (37729 ⁴⁾) / 37909 (37929 ⁴⁾)	9 mm	✓	✓	
37719 (37720 ⁴⁾)	9 mm	✓	✓	

ProLine Membrane-Plaster sealing borders with perforated plaster leg

38610 / 38810	10 mm	✓	✓	✓
38614 / 38814	14 mm	✓	✓	✓
38807	7 mm	✓	✓	✓

TopLine-Plaster sealing borders with plaster leg

39828	28 mm	✓	✓	✓
-------	-------	---	---	---

Special solution, object-specific planning required

Plaster connections for windows in front not executable

1) Applies up to an edge or reveal length of 2.6 m.

2) The specified „movement classes connection“ are minimum requirements for the respective installation situation and window/door size.

3) By depositing a sufficiently dimensioned and placed pre-compressed sealing tape, the SAF resp. VPDM movement class A / Önorm B6400 class III can be achieved. The strip then serves only as a peel-off aid.

4) Color anthracite

PROFILE SELECTION

PLASTER- AND PLASTER SEALING BORDERS



Position in relation to masonry		centered			flush			orset		
WDVS										
Window/door size		≤ 2,6m ²	≤ 6m ²	≤ 10m ²	≤ 2,6m ²	≤ 6m ²	≤ 10m ²	≤ 2,6m ²	≤ 6m ²	≤ 10m ²
Movement class connection ²⁾		Class C	Class C	Class B	Class B	Class A	Class A	Class A	Class A	Class A
Art.Nr.	Profile-Width									

BasicLine³⁾-Plaster sealing borders with plaster leg and mesh

37806 ¹⁾	6 mm	✓	✓	3)	3)	3)	3)	3)	3)	3)
37809 ¹⁾	9 mm	✓	✓							
37906 ¹⁾	6 mm	✓	✓							
37909 ¹⁾ /(37929 ¹⁾⁴⁾	9 mm	✓	✓							

ProLine-Plaster sealing borders membrane with plaster leg and mesh

38807 ¹⁾	7 mm	✓	✓	✓	✓	✓	✓	✓	✓	✓
38810 ¹⁾	10 mm	✓	✓	✓	✓	✓	✓	✓	✓	✓
38814 ¹⁾	14 mm	✓	✓	✓	✓	✓	✓	✓	✓	✓

TopLine-Plaster sealing borders with plaster leg and fabric (can be used without adhesive test)

39828 ¹⁾	28 mm	✓	✓	✓	✓	✓	✓	✓	✓	✓
---------------------	-------	---	---	---	---	---	---	---	---	---

- 1) Applies up to an edge or reveal length of 3.9 m or a maximum of 4.5 m for profiles with a bar length of 3 m.
- 2) The specified „movement classes connection“ are minimum requirements for the respective installation situation and window/door size.
- 3) By depositing a sufficiently dimensioned and placed pre-compressed sealing tape, the SAF or VDPM movement class A / Önorm B6400 class III can be achieved. The strip then serves only as a peel-off aid.
- 4) Color anthracite

Additional notes to the table

- The selection tables for ETICS apply to insulation thicknesses up to 300 mm.
- Protektor plaster sealing strips with perforated plaster leg can be used with exterior plasters in the above-mentioned installation situations mentioned above, even with colored windows without restriction (without increasing the movement class!). can be used. The functionality has been proven in cooperation with ift Rosenheim.
- When using colored metal and plastic windows, the higher movement class must be used for ETICS. (e.g. instead of class C => class B). This requirement is fulfilled for profiles of movement class A.
- Especially when working on critical substrates such as foiled plastic windows, painted wooden windows, powder-coated aluminum windows, etc., it is advisable to use a connection solution without adhesive connection (e.g. plaster sealing strip 39828 with precompressed joint sealing tape applied on site).
- In principle, all Protektor plaster sealing strips and plaster sealing strips (from movement class D) can be used for interior plasters. Plaster sealing strips with a perforated plaster leg offer more safety due to better plaster integration

SOFFIT CONNECTION PROFILES

Frameseal bead with shadow gap

Self-adhesive plastering strip made of PVC with shadow gap and tear-off adhesive tab for foil covering, for interior plastering and exterior rendering.

Colour: 10 - white
Shadow gap: 3 mm



Item number	Plaster thickness (mm)	Length (cm)	Colour	Order number	Material	Package/ Large pack
37606	6 mm	260	10 - white	111385	Rigid PVC with soft PVC	40 PCS / 36 BOX

Frameseal bead with protecting lip

Self-adhesive PVC window frame sealing bead with protective lip and detachable adhesive tab for coverage foil, for interior and exterior plaster.

Colour: 10 - white



Item number	Plaster thickness (mm)	Length (cm)	Colour	Order number	Material	Package/ Large pack
37706	6 mm	260	10 - white	111387	Rigid PVC with soft PVC	40 PCS / 36 BOX

Frameseal bead with protecting lip

Self-adhesive PVC window frame sealing bead with protective lip and detachable adhesive tab for coverage foil, for interior and exterior plaster.

Colour: 10 - white



Item number	Plaster thickness (mm)	Length (cm)	Colour	Order number	Material	Package/ Large pack
37111	6 mm	260	10 - white	109681	Rigid PVC with soft PVC	30 PCS / 120 BOX
	6 mm	300	10 - white	109518	Rigid PVC with soft PVC	60 PCS / 36 BOX

Frameseal bead with shadow gap

Self-adhesive PVC window frame sealing bead with shadow joint and detachable adhesive tab for coverage foil, for interior and exterior plaster.

Colour: 10 - white
Shadow gap: 2 mm



Item number	Plaster thickness (mm)	Length (cm)	Colour	Order number	Material	Package/ Large pack
37103	6 mm	260	10 - white	112382	Hard PVC	50 PCS / 64 BOX

Frameseal bead with shadow gap

Self-adhesive PVC window frame sealing bead with shadow joint and detachable adhesive tab for coverage foil, for interior and exterior plaster.

Colour: 10 - white
Shadow gap: 2 mm



Item number	Plaster thickness (mm)	Length (cm)	Colour	Order number	Material	Package/ Large pack
37104	9 mm	260	10 - white	112384	Hard PVC	60 PCS / 36 BOX

SOFFIT CONNECTION PROFILES

Frameseal bead with protecting lip

Self-adhesive PVC window frame sealing bead with protective lip. Complete with elastic moving elements and detachable glue flap for foil covering, for interior and exterior plaster. **Colour:** 10 - white



NEW

Item number	Plaster thickness (mm)	Length (cm)	Colour	Order number	Material	Package/ Large pack
37112	ab 9 mm	260	10 - white	118811	Rigid PVC with soft PVC	60 PCS / 36 BOX
	ab 9 mm	300	10 - white	118812	Rigid PVC with soft PVC	60 PCS / 36 BOX

Frameseal bead with flexible element, protecting lip

Self-adhesive PVC window frame sealing bead with protective lip. Complete with elastic moving elements and detachable glue flap for foil covering, for interior and exterior plaster. **Colour:** 10 - white



Item number	Plaster thickness (mm)	Length (cm)	Colour	Order number	Material	Package/ Large pack
3726	9 mm	150	10 - white	116153	Rigid PVC with soft PVC	50 PCS / 36 BOX
	9 mm	230	10 - white	116154	Rigid PVC with soft PVC	50 PCS / 36 BOX
	9 mm	260	10 - white	116155	Rigid PVC with soft PVC	50 PCS / 36 BOX

Frameseal bead with shadow gap

Self-adhesive plastering strip made of PVC with shadow gap and tear-off adhesive tab for foil covering, for interior plastering and exterior rendering. **Colour:** 10 - white
Shadow gap: 3 mm



Item number	Plaster thickness (mm)	Length (cm)	Colour	Order number	Material	Package/ Large pack
37609	9 mm	260	10 - white	110863	Hard PVC	40 PCS / 36 BOX

Frameseal bead with protecting lip

Self-adhesive plastering strip made of PVC with protective lip and tear-off adhesive tab for foil covering, for interior plaster. **Colour:** 10 - white



Item number	Plaster thickness (mm)	Length (cm)	Colour	Order number	Material	Package/ Large pack
37709	9 mm	260	10 - white	110865	Rigid PVC with soft PVC	40 PCS / 36 BOX
37729	9 mm	260	91 - anthracite	114193	Rigid PVC with soft PVC	40 PCS / 36 BOX
	9 mm	300	91 - anthracite	114194	Rigid PVC with soft PVC	40 PCS / 36 BOX

SOFFIT CONNECTION PROFILES

Frameseal bead with protecting lip

Self-adhesive plastering strip made of PVC with protective lip and tear-off adhesive tab for foil covering, for interior plaster.

Colour: 10 - white



Item number	Plaster thickness (mm)	Length (cm)	Colour	Order number	Material	Package/ Large pack
37719	9 mm	260	10 - white	114049	Rigid PVC with soft PVC	30 PCS / 36 BOX
	9 mm	300	10 - white	114262	Rigid PVC with soft PVC	30 PCS / 36 BOX
37720	9 mm	260	91 - anthracite	114191	Rigid PVC with soft PVC	30 PCS / 36 BOX
	9 mm	300	91 - anthracite	114192	Rigid PVC with soft PVC	30 PCS / 36 BOX

Frameseal bead with shadow gap, membrane

Self-adhesive plaster sealing strip made of PVC with shadow gap and membrane and tear-off adhesive tab for foil covering, for interior plastering and exterior rendering.

Colour: 10 - white
Shadow gap: 2 mm



Item number	Plaster thickness (mm)	Length (cm)	Colour	Order number	Material	Package/ Large pack
38610	10 mm	260	10 - white	114730	Rigid PVC with soft PVC	35 PCS / 36 BOX
38614	14 mm	260	10 - white	114731	Rigid PVC with soft PVC	35 PCS / 24 BOX

Frameseal bead with shadow gap, membrane

Self-adhesive plaster sealing strip made of PVC with shadow gap and membrane and tear-off adhesive tab for foil covering. Profile width 13 mm for interior plastering and exterior rendering.

Colour: 10 - white

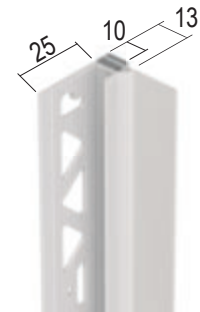

NEW

Item number	Plaster thickness (mm)	Length (cm)	Colour	Order number	Material	Package/ Large pack
38613	13 mm	260	10 - white	119109	Rigid PVC with soft PVC	30 PCS / 50 BOX

Frameseal bead with shadow gap

Self-adhesive PVC window frame sealing bead with shadow joint and detachable adhesive tab for coverage foil, for interior and exterior plaster.

Colour: 10 - white
Shadow gap: 10 mm



Item number	Plaster thickness (mm)	Length (cm)	Colour	Order number	Material	Package/ Large pack
3711	10 mm	260	10 - white	117814	Rigid PVC with soft PVC	60 PCS / 36 BOX

SOFFIT CONNECTION PROFILES

Frame seal bead with protecting lip

Self-adhesive PVC window frame sealing bead with protective lip. Complete with elastic moving elements and detachable glue flap for foil covering, for interior and exterior plaster. **Colour:** 10 - white



Item number	Plaster thickness (mm)	Length (cm)	Colour	Order number	Material	Package/ Large pack
3712	10 mm	150	10 - white	115834	Rigid PVC with soft PVC	60 PCS / 36 BOX
	10 mm	230	10 - white	115836	Rigid PVC with soft PVC	60 PCS / 36 BOX
	10 mm	260	10 - white	115284	Rigid PVC with soft PVC	60 PCS / 36 BOX
	10 mm	300	10 - white	115840	Rigid PVC with soft PVC	60 PCS / 36 BOX

Frame seal flex bead with protecting lip

Self-adhesive PVC window frame sealing bead with protective lip. Complete with elastic moving elements and detachable glue flap for foil covering, for interior and exterior plaster. **Colour:** 10 - white



Item number	Plaster thickness (mm)	Length (cm)	Colour	Order number	Material	Package/ Large pack
37129	10 mm	260	10 - white	116680	Rigid PVC with soft PVC	60 PCS / 36 BOX

Frame seal bead with protecting lip

Self-adhesive plastering strip made of PVC with protective lip and tear-off adhesive tab for foil covering. Self-adhesive foam tape, closed cell. Profile width 16 mm for interior plaster. **Colour:** 10 - white

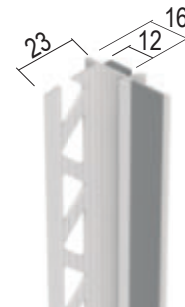

NEW

Item number	Plaster thickness (mm)	Length (cm)	Colour	Order number	Material	Package/ Large pack
37716	16 mm	260	10 - white	119105	Rigid PVC with soft PVC	30 PCS / 36 BOX

Frame seal bead with protecting lip, mesh

Self-adhesive plaster sealing strip made of PVC with sewn-on alkali-resistant glass fibre fabric, protective lip and tear-off adhesive tab for foil covering. Self-adhesive foam tape, closed cell. Profile with 16 mm for ETIC systems. **Colour:** 10 - white

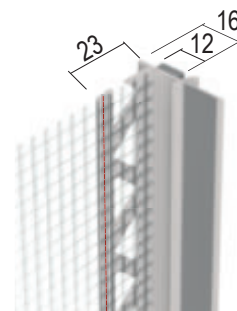

NEW

Item number	Plaster thickness (mm)	Length (cm)	Colour	Order number	Material	Package/ Large pack
37916	16 mm	260	10 - white	119107	Rigid PVC with soft PVC and glass fibre mesh	50 PCS / 13 BOX

SOFFIT CONNECTION PROFILES

Frameseal bead with shadow gap, mesh

Self-adhesive PVC window frame sealing bead with alkali-resistant fibreglass mesh, shadow joint and detachable adhesive tab for coverage foil. For heat insulation with 6-mm plaster thickness.

Colour: 10 - white
Shadow gap: 3 mm
Fabric dimension: 100 mm
Mesh size: 4 x 4 mm
Grammage: 160 g/m²

Notes:
 Single-sided mesh overlap of 10 cm from end of bar.

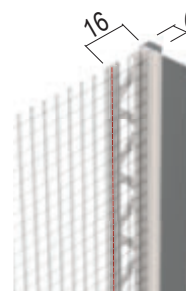

Item number	Plaster thickness (mm)	Length (cm)	Colour	Order number	Material	Package/ Large pack
37806	6 mm	260	10 - white	111389	Rigid PVC with glass fibre mesh	50 PCS / 13 BOX

Frameseal bead with protecting lip, mesh

Self-adhesive plaster sealing strip made of PVC with sewn-on alkali-resistant glass fibre fabric, protective lip and tear-off adhesive tab for foil covering. Profile with 6 mm for ETIC systems.

Colour: 10 - white
Fabric dimension: 100 mm
Mesh size: 4 x 4 mm
Grammage: 160 g/m²

Notes:
 Single-sided mesh overlap of 10 cm from end of bar.

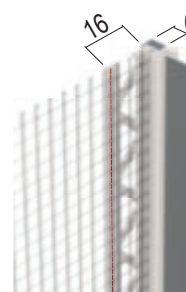

Item number	Plaster thickness (mm)	Length (cm)	Colour	Order number	Material	Package/ Large pack
37906	6 mm	260	10 - white	111391	Rigid PVC with soft PVC and glass fibre mesh	50 PCS / 13 BOX
	6 mm	300	10 - white	111924	Rigid PVC with soft PVC and glass fibre mesh	50 PCS / 13 BOX

Frameseal bead with shadow gap, mesh

Self-adhesive plastering strip made of PVC with shadow gap and tear-off adhesive tab for foil covering. Profile width 9 mm for interior plastering and exterior rendering.

Colour: 10 - white
Shadow gap: 3 mm
Fabric dimension: 100 mm
Mesh size: 4 x 4 mm
Grammage: 160 g/m²

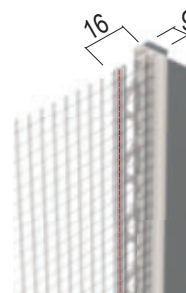

Item number	Plaster thickness (mm)	Length (cm)	Colour	Order number	Material	Package/ Large pack
37809	9 mm	260	10 - white	110867	Rigid PVC with glass fibre mesh	50 PCS / 13 BOX

SOFFIT CONNECTION PROFILES

Frameseal bead with protecting lip, mesh

Self-adhesive plaster sealing strip made of PVC with sewn-on alkali-resistant glass fibre fabric, protective lip and tear-off adhesive tab for foil covering. Profile with 9 mm for ETIC systems.

Colour: 10 - white
Fabric dimension: 100 mm
Mesh size: 4 x 4 mm
Grammage: 160 g/m²

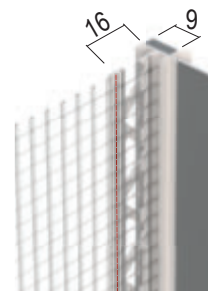

Item number	Plaster thickness (mm)	Length (cm)	Colour	Order number	Material	Package/ Large pack
37909	9 mm	260	10 - white	110869	Rigid PVC with soft PVC and glass fibre mesh	50 PCS / 13 BOX
	9 mm	300	10 - white	111923	Rigid PVC with soft PVC and glass fibre mesh	50 PCS / 13 BOX
	9 mm	300	BD - brown	112162	Rigid PVC with soft PVC and glass fibre mesh	50 PCS / 13 BOX
37929	9 mm	260	91 - anthracite	114195	Rigid PVC with soft PVC and glass fibre mesh	50 PCS / 13 BOX
	9 mm	300	91 - anthracite	114196	Rigid PVC with soft PVC and glass fibre mesh	50 PCS / 13 BOX

Frameseal bead with shadow gap, membrane and mesh

Self-adhesive white PVC window frame sealing bead with membrane for increased absorption of movements, with sewn alkaline resistant fibre-glass mesh, shadow joint and detachable adhesive flap for foil cover. For ETICS with render thickness starting from 6 mm and base render starting from 10 mm. Profile width 10 mm.

Colour: 10 - white
Shadow gap: 2 mm
Fabric dimension: 100 mm
Mesh size: 4 x 4 mm
Grammage: 160 g/m²
Notes:
 Single-sided mesh overlap of 10 cm from end of bar.

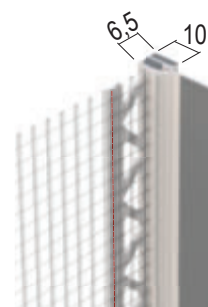

Item number	Plaster thickness (mm)	Length (cm)	Colour	Order number	Material	Package/ Large pack
38810	10 mm	260	10 - white	114524	Rigid PVC with soft PVC and glass fibre mesh	25 PCS / 20 BOX
38814	14 mm	260	10 - white	114525	Rigid PVC with soft PVC and glass fibre mesh	25 PCS / 20 BOX

SOFFIT CONNECTION PROFILES

Roller shutter connecting prof. shadow gap, membrane mesh

Self-adhesive white PVC window frame sealing bead with membrane for increased absorption of movements. For the lateral connection between render and roller shutter guide rails. With sewn alkaline resistant fibreglass mesh, shadow joint and detachable adhesive flap for foil cover. Profile width 7 mm, for ETICS.

Colour: 10 - white
Shadow gap: 3 mm
Fabric dimension: 100 mm
Mesh size: 4 x 4 mm
Grammage: 145 g/m²
Notes:
 Single-sided mesh overlap of 10 cm from end of bar.

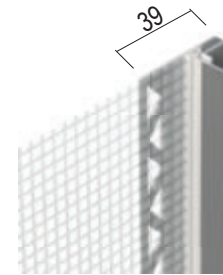

Item number	Plaster thickness (mm)	Length (cm)	Colour	Order number	Material	Package/ Large pack
38807	7 mm	260	10 - white	114672	Rigid PVC with soft PVC and glass fibre mesh	25 PCS / 40 BOX

Frameseal bead with shadow gap and mesh

Self-adhesive white PVC window frame sealing bead with membrane for increased absorption of movements, with sewn alkaline resistant fibreglass mesh, shadow joint and detachable adhesive flap for foil cover. Self-adhesive closed-cell foam tape. For carrying out optically and technically perfect connections between window frames and render, permeable. Profile width 14 mm, for ETICS with render thickness starting from 6 mm.

Colour: 10 - white
Shadow gap: 2 mm
Fabric dimension: 100 mm
Grammage: 160 g/m²
Mesh size: 4 x 4 mm mm
Notes:
 Single-sided mesh overlap of 10 cm from end of bar.

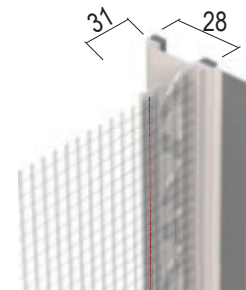

Item number	Plaster thickness (mm)	Length (cm)	Colour	Order number	Material	Package/ Large pack
39828	6 mm	260	10 - white	115771	Rigid PVC with soft PVC and glass fibre mesh	30 PCS / 8 BOX

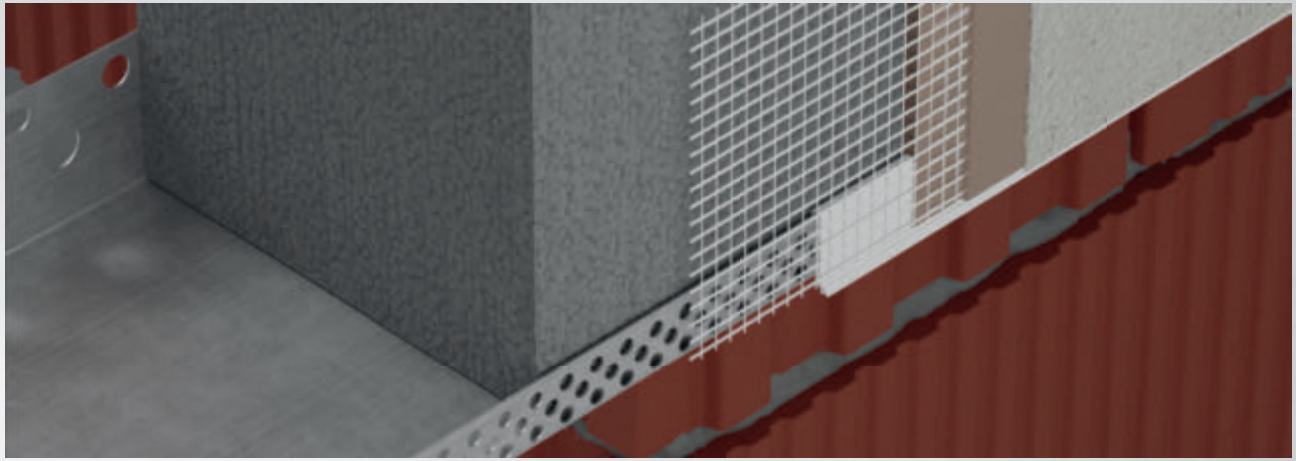

GENERAL INFORMATION

- Für For thermal insulation, Protektor offers a large portfolio of profiles for optimal, safe and durable detailed solutions on the thermally insulated exterior façade. The profiles for external thermal insulation composite systems (ETICS) are mainly made of PVC with glass-fibre fabric (according to ETAG004) or of aluminum. Profiles made of galvanized steel with PVC coating are used for thermal insulation plasters.
- Basically, the regulations, recommendations and system approvals of the plaster and system manufacturers as well as the other trades involved in the construction must be observed.
- Cut PVC profiles to the required installation dimension using suitable PVC shears (e.g. Protektor profile shears). Cut metal profiles with hand shears or a suitable cutting disc. Only process stainless steel profiles with rustproof tools and cut them with a cutting disc recommended for stainless steel.
- Plaster sealing strips with self-adhesive foam tape are glued to the substrate plumb and flush. The bonding area must generally be dry, clean, free of frost, dust and grease and have sufficient load-bearing capacity. To assess the suitability for bonding, a bonding test must generally be carried out.
- The profiles and, if necessary, the glass-fibre fabric strip are applied to the insulation surface over the entire surface with system reinforcement mortar and additionally covered completely up to the front edge of the profile with surface fabric.
- If profile joints are required, overlap any existing fabric protrusions. All profile joints must be completely covered with at least 10 cm of surface fabric.
- The tear-off adhesive tab for applying a protective film should only be removed after application of the finishing coat.
- Do not plaster over visible PVC surfaces, clean immediately after plastering.
- Aluminum base profiles with projections ≥ 80 mm must be temporarily secured against tilting for installation of the first insulation board row.
- Elastic middle parts of expansion joint profiles and metal surfaces that remain visible must be masked off before plastering. The masking strip must be removed immediately after plastering.
- Store all profiles in a dry place! Additionally, store PVC profiles in a cool and frost-free place, horizontally and lying flat.

All standards and guidelines on the subject of plaster and ETICS in their current version must be observed, in particular DIN 55699, Ö-Norm B6400 as well as the guidelines and leaflets of the associations:

- Guideline „Fassadensockelputz / Außenanlagen“ from the Fachverband der Stuckateure für Ausbau und Fassade Baden-Württemberg (SAF) and other associations.
- Guideline „Metal Connections to Plaster, External Thermal Insulation and External Thermal Insulation Composite Systems“ from the Fachverband der Stuckateure für Ausbau und Fassade Baden-Württemberg (SAF) and other associations.
- Guideline „Connections to windows and roller shutters in plaster, external thermal insulation composite systems and drywall construction“ by the Fachverband der Stuckateure für Ausbau und Fassade Baden-Württemberg (SAF), the Fachverband Glas, Fenster, Fassade Baden-Württemberg and the Bundesverband Rollläden + Sonnenschutz e. V.
- Leaflet „Formation of details with profiles and joint sealing tapes for external rendering and ETICS“ from the Association for Insulation Systems, Plaster and Mortar (VDPM)
- „Processing Guideline for Plastering and Finishing Profiles“ by the Austrian Working Group for Plaster (ÖAP)
- „Processing Guideline for External Thermal Insulation Composite Systems“ of the Austrian Quality Group for Thermal Insulation Systems (QG)

The product information as well as the additional information with the respective product illustrations in this catalogue and the further notes in our product data sheets and processing instructions on our homepage must be observed!

For the selection of the plastering strips and plastering sealing strips, the corresponding selection tables according to movement classes and areas of application in this catalogue must be observed, as well as the complete instructions for selection, processing and installation on our homepage.



CORNER PROFILES

Corner bead with mesh and hood for thermal insulation

Corner bead with mesh made of rigid PVC, with sealing edge and alkali-resistant fibreglass mesh, for heat insulation with plaster thicknesses of 3 mm and greater.

Colour: 10 - white
Fabric dimension: 100/150 mm
Mesh size: 4 x 4 mm
Grammage: 145 g/m²

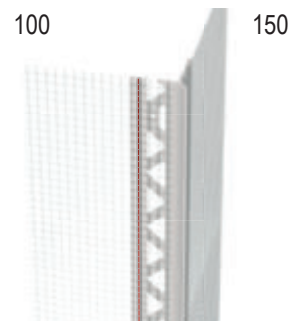

Item number	Plaster thickness (mm)	Length (cm)	Order number	Material	Fabric dimension	Package/ Large pack
NEW 37521	3 mm	250	119418	Hard PVC	100/150 mm	50 PCS / 8 BOX
NEW 37524	6 mm	250	109634	Hard PVC	100/150 mm	50 PCS / 15 BOX
	6 mm	250	119420	Hard PVC	100/150 mm	50 PCS / 8 BOX

Stop profile for insulation

Stop profile for insulation 20 mm

Material thickness: 0,8 mm
color value: 10 - white

Item number	Insulating boards (mm)	Length (cm)	Order number	Material	Package/ Large pack
NEW 92422	20	250	119508	Aluminum, with basic coating	10 PCS / 100 BUN
NEW 92424	40	250	119507	Aluminum, with basic coating	10 PCS / 56 BUN
NEW 92426	60	250	119506	Aluminum, with basic coating	10 PCS / 40 BUN
NEW 92428	80	250	119505	Aluminum, with basic coating	10 PCS / 32 BUN
NEW 92430	100	250	119504	Aluminum, with basic coating	10 PCS / 24 BUN

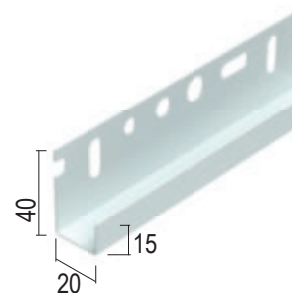

Corner bead with mesh and hood for thermal insulation

Corner bead with mesh made of rigid PVC, with sealing edge and alkali-resistant fibreglass mesh, for heat insulation with plaster thicknesses of 6 mm and greater.

Colour: 10 - white
Fabric dimension: 80/120 mm
Mesh size: 4 x 4 mm
Grammage: 145 g/m²

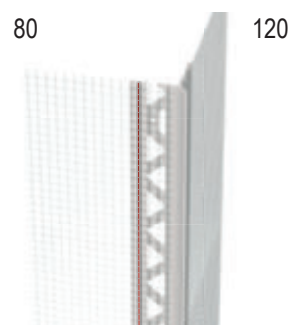

Item number	Plaster thickness (mm)	Length (cm)	Order number	Material	Fabric dimension	Package/ Large pack
NEW 37523	6 mm	250	109635	Hard PVC	80/120 mm	50 PCS / 15 BOX
	6 mm	250	119419	Hard PVC	80/120 mm	50 PCS / 8 BOX

Corner bead with mesh and hood for thermal insulation

Corner bead with mesh made of rigid PVC, with sealing edge and alkali-resistant fibreglass mesh, for heat insulation with plaster thicknesses of 10 mm and greater.

Colour: 10 - white
Fabric dimension: 100/150 mm
Mesh size: 4 x 4 mm
Grammage: 145 g/m²

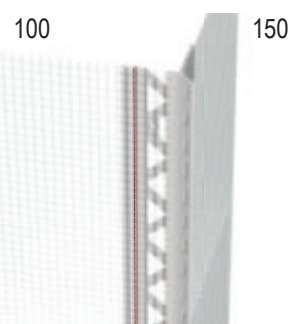

Item number	Plaster thickness (mm)	Length (cm)	Order number	Material	Fabric dimension	Package/ Large pack
NEW 37525	10 mm	250	110675	Hard PVC	100/150 mm	25 PCS / 15 BOX
	10 mm	250	119421	Hard PVC	100/150 mm	25 PCS / 8 BOX
37526	14 mm	250	110673	Hard PVC	100/150 mm	25 PCS / 8 BOX

CORNER PROFILES

Corner bead with mesh for thermal insulation

Corner bead with mesh made of rigid PVC, with alkali-resistant fibreglass mesh, for heat insulation.

Colour: 10 - white
Fabric dimension: 100/230 mm
Mesh size: 4 x 4 mm
Grammage: 160 g/m²

Notes:
 One-sided tissue protrusion of 10 cm at the end of the bar.

Item number	Length (cm)	Order number	Material	Fabric dimension	Package/ Large pack
37968	250	108166	Rigid PVC with glass fibre mesh	100/230 mm	50 PCS / 23 BOX
37969	250	109504	Rigid PVC with glass fibre mesh	100/300 mm	50 PCS / 24 BOX

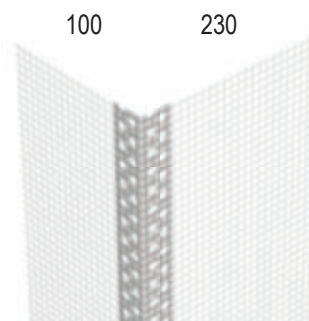

Corner bead with mesh for thermal insulation

Corner bead with mesh made of rigid PVC, with alkali-resistant fibreglass mesh, for heat insulation.

Colour: 10 - white
Fabric dimension: 100/150 mm
Mesh size: 4 x 4 mm
Grammage: 145 g/m²

Notes:
 One-sided tissue protrusion of 10 cm at the end of the bar.

Item number	Length (cm)	Order number	Material	Fabric dimension	Package/ Large pack
3797	250	111694	Rigid PVC with glass fibre mesh	100/150 mm	100 PCS / 15 BOX
3799	250	111697	Rigid PVC with glass fibre mesh	80/120 mm	100 PCS / 15 BOX

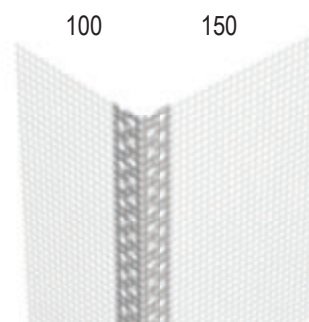

Corner bead with mesh for thermal insulation

Aluminium corner bead with mesh, with alkali-resistant fibreglass mesh, for heat insulation.

Mesh size: 4 x 4 mm
Grammage: 145 g/m²

Notes:
 One-sided tissue protrusion of 10 cm at the end of the bar.

Item number	Length (cm)	Order number	Material	Fabric dimension	Package/ Large pack
9075	250	113732	Aluminum natural	100/150 mm	50 PCS / 48 BOX

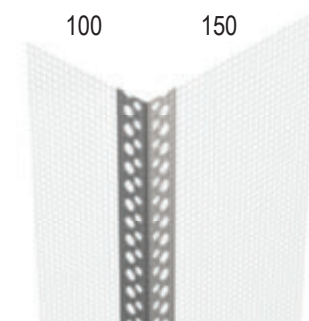

Glass fibre mesh corner bead for thermal insulation

Corner bead with mesh gauge made of alkali resistant armoured fibre, for use on outside and inside corners.

Colour: 10 - white
Fabric dimension: 80/120 mm
Mesh size: 18 x 20 mm
Grammage: 320 g/m²

Notes:
 Suitable for flame-retardant thermal insulation.

Item number	Length (cm)	Order number	Material	Fabric dimension	Package/ Large pack
1092	260	102309	Alkali-resistant glass fibre mesh	80/120 mm	50 PCS / 24 BOX

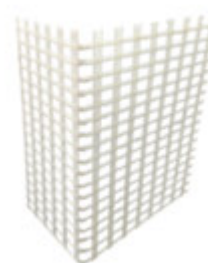

CORNER PROFILES

Glass fibre mesh corner bead for thermal insulation

Corner bead with mesh made of alkali-resistant armoured fibre for use on outside and inside corners.

Colour: 10 - white
Fabric dimension: 90/70 mm
Mesh size: 18 x 7 mm
Grammage: 280 g/m²
Notes:
 Suitable for flame-retardant thermal insulation.



Item number	Length (cm)	Order number	Material	Fabric dimension	Package/ Large pack
1096	5	113667	Alkali-resistant glass fibre mesh	90/70 mm	1 ROL / 80 BOX

Flexible corner bead with mesh for thermal insulation

Variable PVC corner bead with mesh, with alkali-resistant fibreglass mesh, for heat insulation.

Colour: 10 - white
Fabric dimension: 90/110 mm
Mesh size: 4 x 4 mm
Grammage: 145 g/m²
Notes:
 The "kink fold" allows users to create various acute and obtuse angled edges (e.g. 135° edges).

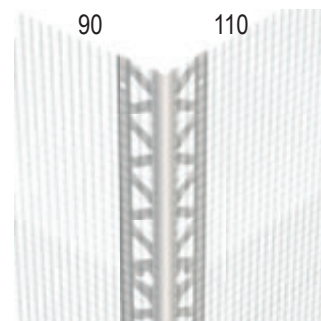

Item number	Length (cm)	Order number	Material	Fabric dimension	Package/ Large pack
3752	5	105505	Hard PVC	90/110 mm	1 ROL / 20 BOX

Corner bead with mesh for thermal insulation

PVC corner bead with mesh with alkali-resistant fibreglass mesh for creating exact edges in thermal insulation systems. White glass fibre mesh with black imprint "PROTEKTOR".

Mesh size: 4 x 4 mm
Grammage: 145 g/m²

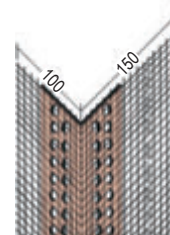

Item number	Insulating boards (mm)	Length (cm)	Order number	Plaster thickness (mm)	Material	Package/ Large pack
37976		250	112302		PVC	100 PCS / 15 BOX

PLASTER/RENDER STOPS

Stop profile with mesh for thermal insulation

Plaster stop profiles made of PVC, with sewn attached alkali-resistant fibreglass mesh, for plaster thicknesses of 3 mm and greater applied to heat insulation.

Colour: 10 - white
Fabric dimension: 100 mm
Mesh size: 4 x 4 mm
Grammage: 160 g/m²

Notes:
 Einseitiger Gewebeüberstand von 10 cm am Stabende.

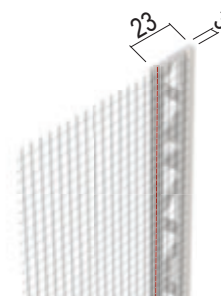

Item number	Insulating boards (mm)	Length (cm)	Order number	Plaster thickness (mm)	Material	Package/ Large pack
3793		250	111532	3 mm	Rigid PVC with glass fibre mesh	50 PCS / 40 BOX
3796		250	111531	6 mm	Rigid PVC with glass fibre mesh	50 PCS / 40 BOX
37098		250	111928	8 mm	Rigid PVC with glass fibre mesh	50 PCS / 40 BOX
3791		250	112024	10 mm	Rigid PVC with glass fibre mesh	40 PCS / 40 BOX
37914		250	111927	14 mm	Rigid PVC with glass fibre mesh	40 PCS / 40 BOX

Stop profile for thermal insulation

Aluminium box-shaped stop profile for thermal insulation systems with different insulation thicknesses (a).

Notes:
 Installation only vertical.

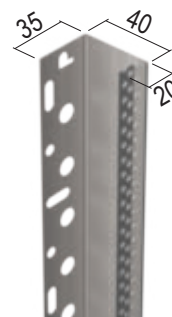

Item number	Insulating boards (mm)	Length (cm)	Order number	Plaster thickness (mm)	Material	Package/ Large pack
93304	40	250	109019		Aluminum natural	10 PCS / 80 BUN
93305	50	250	109020		Aluminum natural	10 PCS / 70 BUN
93306	60	250	109021		Aluminum natural	10 PCS / 60 BUN
93308	80	250	109023		Aluminum natural	10 PCS / 60 BUN
93310	100	250	109025		Aluminum natural	10 PCS / 48 BUN
93312	120	250	109026		Aluminum natural	10 PCS / 40 BUN
93314	140	250	109027		Aluminum natural	6 PCS / 66 BUN
93316	160	250	109028		Aluminum natural	6 PCS / 50 BUN

Stop profile for thermal insulation for roof ventilation

Aluminium corner profile with white case coating for installation between the rafters, providing DIN-conform roof ventilation.

Colour: 10 - white
Notes:
 Ventilation cross section: 207 cm²/lfm.
Ventilation area: 207 cm²/lfm.

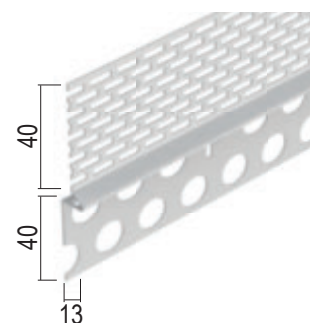

Item number	Plaster thickness (mm)	Length (cm)	Order number	Material	Package/ Large pack
9224	13 mm	250	101992	Aluminum, with basic coating	20 PCS / 70 BUN

DRIP EDGE PROFILES

Water drip nose profile for thermal insulation

Water drip nose profiles for achieving a clean finish in insulated attic constructions or balcony sub-layers, e.g. for insulated passageways, balcony and window lintel undersides with different plaster thicknesses (a). Plastering leg with sewn alkali-resistant glass fiber fabric strip.

Colour: 10 - white
Fabric dimension: 100/100 mm
Mesh size: 4 x 4 mm
Grammage: 160 g/m²
Notes: Single-sided mesh overlap of 10 cm from end of bar.

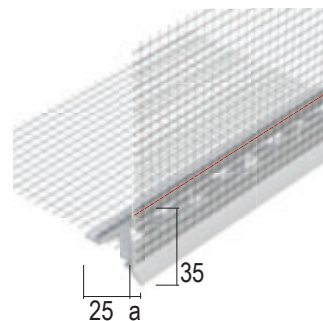

Item number	Insulating boards (mm)	Length (cm)	Order number	Plaster thickness (mm)	Material	Package/ Large pack
3794		250	114609	6 mm	Rigid PVC with glass fibre mesh	25 PCS / 13 BOX
37941		250	114617	10 mm	Rigid PVC with glass fibre mesh	25 PCS / 13 BOX
37942		250	114618	14 mm	Rigid PVC with glass fibre mesh	20 PCS / 13 BOX

Water drip nose profile for thermal insulation

Water drip profiles for achieving a clean finish in insulated attic constructions or balcony sub-layers.

Item number	Insulating boards (mm)	Length (cm)	Order number	Plaster thickness (mm)	Material	Package/ Large pack
9011		250	101936	6 mm	Aluminum natural	20 PCS / 47 BUN
2154		250	101411	6 mm	Stainless steel	20 PCS / 49 BUN

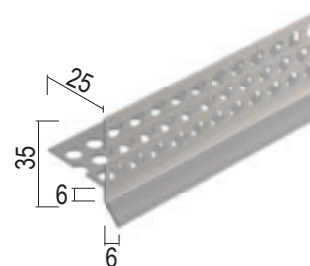

Water drip nose profile for transitions from render to ETIC

Drip edge profile made of PVC with sewn-on alkali-resistant fiberglass fabric for the transition from plasters with a thickness of 14 mm or more to WDV systems with a plaster thickness of 6 mm or more. To produce clean finishes, e.g. B. for insulated passages, balcony and window lintel soffits.

Colour: 10 - white
Fabric dimension: 100/100 mm
Mesh size: 7 x 7 mm/ bzw. 4 x 4 mm
Grammage: 180 / 165 g/m²
Notes: Single-sided mesh overlap of 10 cm from end of bar.

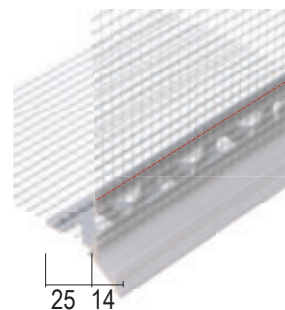

NEW

Item number	Insulating boards (mm)	Length (cm)	Order number	Plaster thickness (mm)	Material	Package/ Large pack
37945		250	119416	6 mm	Rigid PVC with glass fibre mesh	20 PCS / 13 BOX

THERMAL INSULATION

CONNECTING PROFILES

Window sill connection profile for sealing foils

Window sill connection profile made of PVC with sewn-on alkali-resistant glass fiber fabric for ETICS systems. With closed legs for sticking a sealing film as a second sealing level below the window sill.

Colour: 10 - white
Fabric dimension: 100 mm
Mesh size: 4 x 4 mm
Grammage: 160 g/m²
Notes:
 Single-sided mesh overlap of 10 cm from end of bar.

Item number	Plaster thickness (mm)	Length (cm)	Order number	Material	Package/ Large pack
37127	6 mm	250	116989	Rigid PVC with glass fibre mesh	15 PCS / 13 BOX

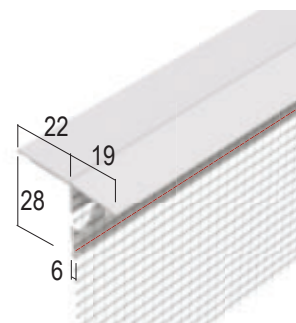

Metal sheet connecting profile for thermal insulation

PVC metal connection profile with sewn alkali-resistant fibreglass mesh, for creating sheet metal coverings with a plaster thickness of 8 mm on thermal insulation systems.

Colour: 10 - white
Fabric dimension: 100 mm
Mesh size: 4 x 4 mm
Grammage: 160 g/m²
Notes:
 One-sided tissue protrusion of 10 cm at the end of the bead.

Item number	Insulating boards (mm)	Length (cm)	Order number	Plaster thickness (mm)	Material	Package/ Large pack
3749		250	116913	8 mm	Rigid PVC with glass fibre mesh	20 PCS / 40 BOX

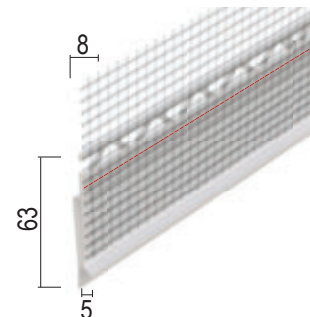

Window sill connection profile for sealing slurry

Window sill connection profile made of PVC with sewn-on alkali-resistant glass fiber fabric for ETICS systems. Additionally with sewn-on alkali-resistant glass fiber fabric for embedding in a sealing slurry as a second sealing level below the window sill.

Colour: 10 - white
Fabric dimension: 100 mm
Mesh size: 4 x 4 mm
Grammage: 160 g/m²
Notes:
 Single-sided mesh overlap of 10 cm from end of bar.

Item number	Plaster thickness (mm)	Length (cm)	Order number	Material	Package/ Large pack
37128	6 mm	250	116990	Rigid PVC with glass fibre mesh	15 PCS / 13 BOX

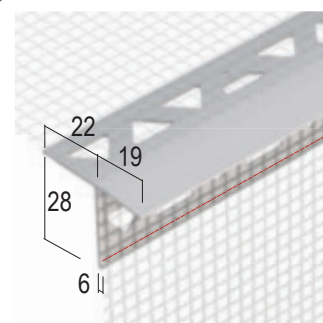

Attica profile for ETICS

White PVC stop profile for plaster thicknesses of 7 mm and greater. For all types of plaster and mortar. With a sealing edge to create precise flush and aligned on the edges of buildings.

Colour: 10 - white
Notes:
 Visible side in white, wings in grey.

Item number	Insulating boards (mm)	Length (cm)	Order number	Plaster thickness (mm)	Material	Package/ Large pack
NEW 37207		250	119452	7 mm	Hard PVC	30 PCS / 13 BOX

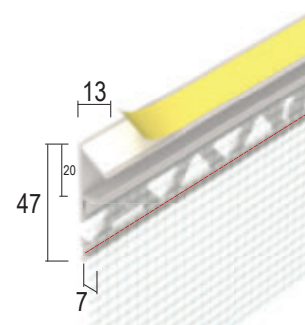

BASE PROFILES

Base profile for thermal insulation

Aluminum base profile for thermal insulation systems with different insulation thicknesses (a).

Material thickness: 0,6 mm
Height (b): 35 mm

Item number	Insulating boards (mm)	Length (cm)	Order number	Plaster thickness (mm)	Material	Package/ Large pack
90602	20	250	108807		Aluminum natural	10 PCS / 72 BUN
90603	30	250	108826		Aluminum natural	10 PCS / 120 BUN
90604	40	250	108825		Aluminum natural	10 PCS / 96 BUN
90605	50	250	108824		Aluminum natural	10 PCS / 90 BUN
90606	60	250	108823		Aluminum natural	10 PCS / 91 BUN
90607	70	250	108822		Aluminum natural	10 PCS / 84 BUN
90608	80	250	108806		Aluminum natural	10 PCS / 66 BUN
90609	90	250	108805		Aluminum natural	10 PCS / 60 BUN
90610	100	250	108783		Aluminum natural	10 PCS / 63 BUN
SALE 90616	160	250	108780		Aluminum natural	6 PCS / 48 BUN

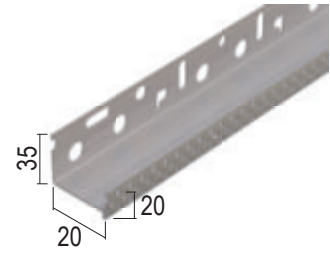

Base profile for thermal insulation

Aluminum base profile for thermal insulation systems with different insulation thicknesses (a).

Material thickness: 0,8 mm
Height (b): 35 mm

Item number	Insulating boards (mm)	Length (cm)	Order number	Plaster thickness (mm)	Material	Package/ Large pack
90804	40	250	108811		Aluminum natural	10 PCS / 96 BUN
90805	50	250	108810		Aluminum natural	10 PCS / 84 BUN
90806	60	250	108809		Aluminum natural	10 PCS / 78 BUN
90808	80	250	108793		Aluminum natural	10 PCS / 66 BUN
90810	100	250	108760		Aluminum natural	10 PCS / 54 BUN
90811	110	250	108759		Aluminum natural	6 PCS / 60 BUN
NEW 90812	120	250	119201		Aluminum natural	6 PCS / 70 BUN
NEW 90814	140	250	119212		Aluminum natural	6 PCS / 56 BUN
NEW 90816	160	250	119220		Aluminum natural	6 PCS / 56 BUN
NEW 90818	180	250	119236		Aluminum natural	6 PCS / 42 BUN
NEW 90820	200	250	119253		Aluminum natural	6 PCS / 39 BUN

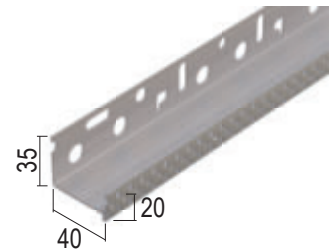

BASE PROFILES

Base profile for thermal insulation

Aluminium base profile for thermal insulation systems with different insulation thicknesses (a).

Material thickness: 1 mm
Height (b): 35 mm

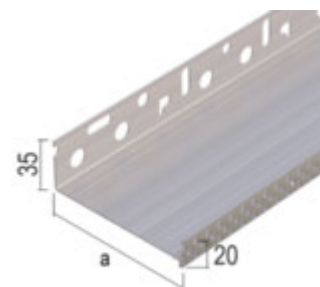

Item number	Insulating boards (mm)	Length (cm)	Order number	Plaster thickness (mm)	Material	Package/ Large pack
91010	100	250	108772		Aluminum natural	10 PCS / 54 BUN
91012	120	250	108784		Aluminum natural	6 PCS / 60 BUN
91013	130	250	109540		Aluminum natural	6 PCS / 48 BUN
NEW 91014	140	250	119271		Aluminum natural	6 PCS / 56 BUN
91015	150	250	119276		Aluminum natural	6 PCS / 52 BUN
91016	160	250	108648		Aluminum natural	6 PCS / 48 BUN
91018	180	250	119282		Aluminum natural	6 PCS / 39 BUN
NEW 91020	200	250	119286		Aluminum natural	6 PCS / 36 BUN
NEW 91022	220	250	119289		Aluminum natural	6 PCS / 42 BUN

Base profiles for thermal insulation

Aluminium base profile, two-part, for thermal insulation systems with insulation thicknesses of 200-300 mm.

Height (b): 42 mm
Material thickness: 1,5 mm

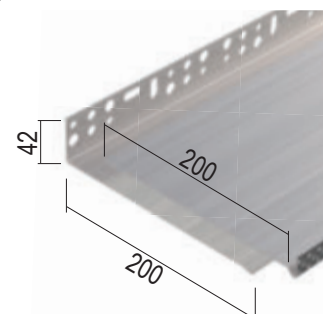

Item number	Insulating boards (mm)	Length (cm)	Order number	Plaster thickness (mm)	Material	Package/ Large pack
9141	ab 200	250	105835		Aluminum natural	4 PCS / 20 BUN

Corved wall connecting profile

Wall bracket made of embossed aluminum with a leg length of 50 mm as a lower support. Insulation material thickness at least 50 mm.

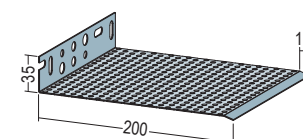

Item number	Insulating boards (mm)	Length (cm)	Order number	Plaster thickness (mm)	Material	Package/ Large pack
95631	50	250	109144		Aluminum	15 PCS / 90 BUN
95632	90	250	109145		Aluminum	15 PCS / 90 BUN
95633	200	250	109146		Aluminum natural	15 PCS / 90 BUN

Connecting element

Connection pieces for box-shaped render profiles.



Item number	Insulating boards (mm)	Length (cm)	Order number	Plaster thickness (mm)	Material	Package/ Large pack
3756		3	102259		Hard PVC	100 PC / 25 BEU

BASE PROFILES

Mounting set ETICX

Assembly set comprised of 50 levelling pieces (3 mm), 75 dowels (6 x 60 mm) and 10 connection pieces (3756) for box-shaped render profiles.

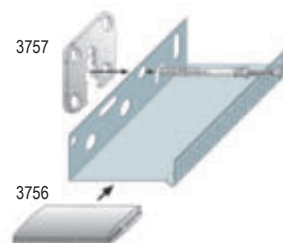

Item number	Insulating boards (mm)	Length (cm)	Order number	Plaster thickness (mm)	Material	Package/ Large pack
3757		20	102264			1 PC / 240 BOX

Clip-on profile for thermal insulation

Box-shaped stainless steel clip-on profiles, for exterior plaster, used to mount or attach to base profiles.



Item number	Insulating boards (mm)	Length (cm)	Order number	Plaster thickness (mm)	Material	Package/ Large pack
2134		250	101340	6 mm	Stainless steel	20 PCS / 196 BUN
2130		250	101325	10 mm	Stainless steel	20 PCS / 156 BUN
2132		250	101334	15 mm	Stainless steel	20 PCS / 132 BUN

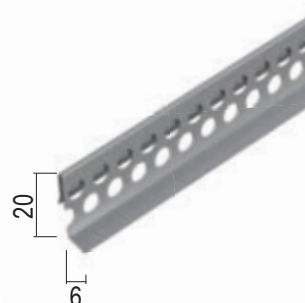

Clip-on profile for thermal insulation

Box-shaped aluminium clip-on profile, for exterior plaster, for mounting or attaching to base profiles.

Item number	Insulating boards (mm)	Length (cm)	Order number	Plaster thickness (mm)	Material	Package/ Large pack
9124		250	103661	6 mm	Aluminum natural	20 PCS / 200 BUN
9121		250	103662	10 mm	Aluminum natural	20 PCS / 156 BUN
9122		250	102465	15 mm	Aluminum natural	20 PCS / 108 BUN

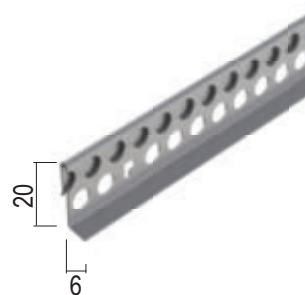

Clip-on profile for thermal insulation

PVC clip-on render stop profile for heat insulation systems with a plaster thickness of 6 mm, with drip edge. Plastering leg made of alkali-resistant fibreglass mesh strips.

Colour: 10 - white
Fabric dimension: 100 mm
Mesh size: 4 x 4 mm
Grammage: 160 g/m²

Notes:
 Single-sided mesh overlap of 10 cm from end of bar.

Item number	Insulating boards (mm)	Length (cm)	Order number	Plaster thickness (mm)	Material	Package/ Large pack
37300		250	110877	6 mm	Rigid PVC with glass fibre mesh	15 PCS / 24 BOX
		250	119189	6 mm	Rigid PVC with glass fibre mesh	15 PCS / 24 BOX
37301		250	111925	10 mm	Rigid PVC with glass fibre mesh	15 PCS / 24 BOX
		250	119190	10 mm	Rigid PVC with glass fibre mesh	15 PCS / 24 BOX
37302		250	111926	14 mm	Rigid PVC with glass fibre mesh	15 PCS / 24 BOX
		250	119191	14 mm	Rigid PVC with glass fibre mesh	15 PCS / 24 BOX

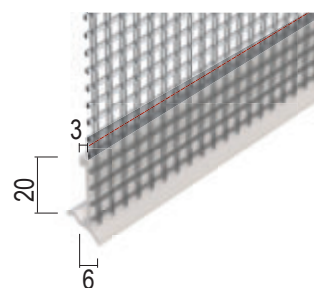

BASE PROFILES

Clip-on profile for thermal insulation

PVC clip-on profile for thermal insulation systems, for 6 mm plaster thickness with sewn alkali-resistant fiberglass mesh.

Also suitable for attaching to the edging profile of the apron of roller shutter and Venetian blind boxes.

Colour: 10 - white

Fabric dimension: 100 mm

Mesh size: 4 x 4 mm

Grammage: 160 g/m²

Notes:

One-sided mesh-overhang of 10 cm at the end of the rod.

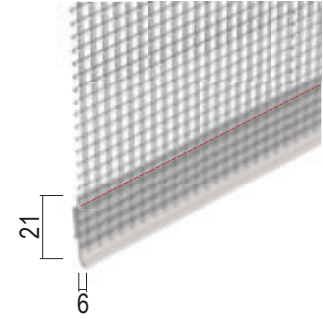

Item number	Insulating boards (mm)	Length (cm)	Order number	Plaster thickness (mm)	Material	Package/ Large pack
37400		250	112324	6 mm	Rigid PVC with glass fibre mesh	15 PCS / 40 BOX
37404		250	112327	8 mm	Rigid PVC with glass fibre mesh	15 PCS / 40 BOX
37401		250	112325	10 mm	Rigid PVC with glass fibre mesh	15 PCS / 40 BOX
37402		250	112326	14 mm	Rigid PVC with glass fibre mesh	15 PCS / 40 BOX

Insertion profile with drip nose for thermal insulation

PVC insertion base profile, for 6 mm plaster thickness, with drip edge. Plastering leg with sewn alkali-resistant glass fiber fabric strip.

Colour: 10 - white

Leg length: 60/40 mm

Fabric dimension: 100 mm

Mesh size: 4 x 4 mm

Grammage: 160 g/m²

Suitable for product: 37539; 37537; 37538

Notes:

One-sided tissue protrusion of 10 cm at the end of the bead.

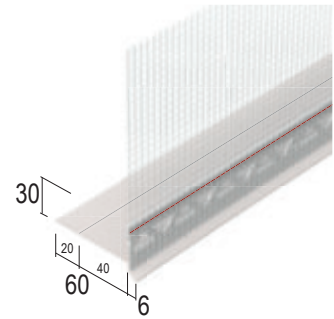

Item number	Insulating boards (mm)	Length (cm)	Order number	Plaster thickness (mm)	Material	Package/ Large pack
37500	ab 40	200	114908	6 mm	Rigid PVC with glass fibre mesh	15 PCS / 25 BOX

Insertion profile with drip nose for thermal insulation

PVC insertion base profile, for 6 mm plaster thickness, with drip edge. Plastering leg with sewn alkali-resistant glass fiber fabric strip.

Colour: 10 - white

Leg length: 60/30 mm

Fabric dimension: 100 mm

Mesh size: 4 x 4 mm

Grammage: 160 g/m²

Suitable for product: 37539; 37537; 37538

Notes:

One-sided tissue protrusion of 10 cm at the end of the bead.

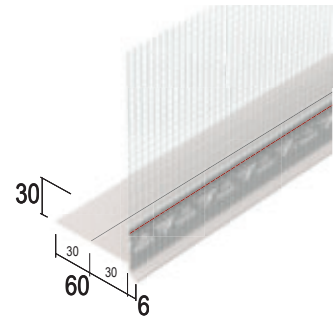

Item number	Insulating boards (mm)	Length (cm)	Order number	Plaster thickness (mm)	Material	Package/ Large pack
37530	ab 30	200	115315	6 mm	Rigid PVC with glass fibre mesh	15 PCS / 13 BOX

Insertion profile with drip nose for thermal insulation

PVC insertion base profile, for 6 mm plaster thickness, with drip edge. Plastering leg with sewn alkali-resistant glass fiber fabric strip.

Colour: 10 - white

Leg length: 100/80 mm

Fabric dimension: 100 mm

Mesh size: 4 x 4 mm

Grammage: 160 g/m²

Suitable for product: 37539; 37537; 37538

Notes:

One-sided tissue protrusion of 10 cm at the end of the bead.

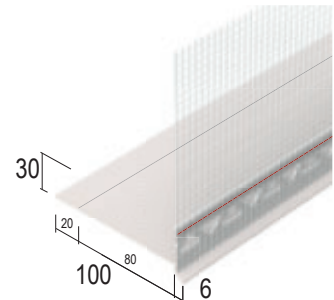

Item number	Insulating boards (mm)	Length (cm)	Order number	Plaster thickness (mm)	Material	Package/ Large pack
37501	ab 80	200	114909	6 mm	Rigid PVC with glass fibre mesh	15 PCS / 25 BOX

BASE PROFILES

Insertion profile with drip nose for thermal insulation

PVC insertion base profile, for 6 mm plaster thickness, with drip edge. Plastering leg with sewn alkali-resistant glass fiber fabric strip.

Colour: 10 - white
Leg length: 60/40 mm
Fabric dimension: 100 mm
Mesh size: 4 x 4 mm
Grammage: 160 g/m²
Suitable for product: 37539; 37537; 37538
Notes:
 One-sided tissue protrusion of 10 cm at the end of the bead.

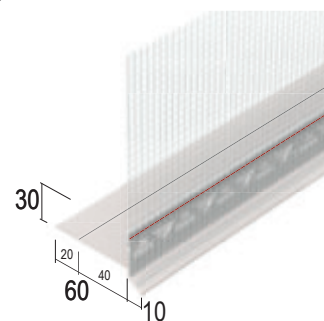

Item number	Insulating boards (mm)	Length (cm)	Order number	Plaster thickness (mm)	Material	Package/ Large pack
37503	ab 40	200	114910	10 mm	Rigid PVC with glass fibre mesh	10 PCS / 25 BOX

Mounting angle ETICS

PVC angle profile use as bottom bad for insulation material.

Colour: 10 - white
Leg length: 40 mm
Suitable for product: 37503; 37501; 37500; 37530
Notes:
 Minimized thermal bridges.

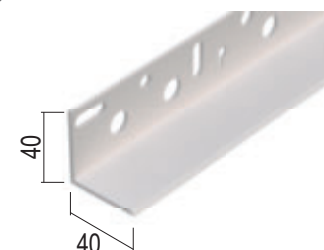

Item number	Insulating boards (mm)	Length (cm)	Order number	Plaster thickness (mm)	Material	Package/ Large pack
37537	ab 40	200	115338		Hard PVC	15 PCS / 36 BOX

Mounting angle ETICS

PVC angle profile use as bottom bad for insulation material.

Colour: 10 - white
Leg length: 100 mm
Suitable for product: 37503; 37501; 37500; 37530
Notes:
 Minimized thermal bridges.

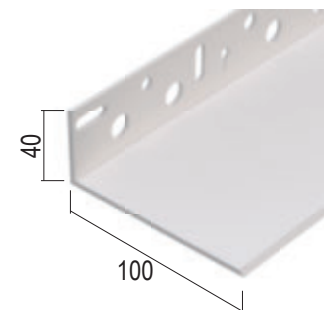

Item number	Insulating boards (mm)	Length (cm)	Order number	Plaster thickness (mm)	Material	Package/ Large pack
37538	ab 100	200	115339		Hard PVC	15 PCS / 40 BOX

Mounting angle ETICS

PVC angle profile use as bottom bad for insulation material.

Colour: 10 - white
Leg length: 160 mm
Suitable for product: 37503; 37501; 37500; 37530
Notes:
 Minimized thermal bridges.

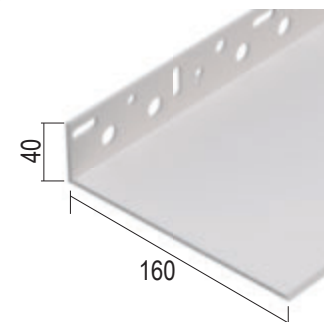

Item number	Insulating boards (mm)	Length (cm)	Order number	Plaster thickness (mm)	Material	Package/ Large pack
37539	ab 160	200	115340		Hard PVC	15 PCS / 30 BOX

BASE PROFILES

Floor connection profile for thermal insulation

Connection profile with drip edge for thermal insulation from 60/6 mm, for inserting connections between thermal insulation and e.g. existing coverings, hard PVC, alkali-resistant fabric

Colour: 10 - white
Fabric dimension: 100 mm
Mesh size: 4 x 4 mm
Grammage: 160 g/m²
Notes:
 One-sided tissue protrusion of 10 cm at the end of the bead.

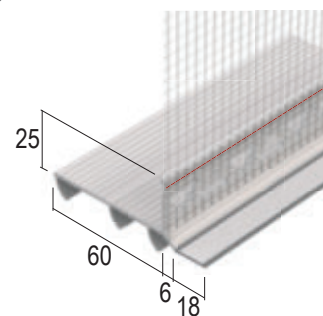

Item number	Insulating boards (mm)	Length (cm)	Order number	Plaster thickness (mm)	Material	Package/ Large pack
37520	ab 30	200	116008	6 mm	Rigid PVC with glass fibre mesh	10 PCS / 25 BOX

Base profile for thermal insulation

Base profile made of PVC, with sewn attached alkali-resistant fibreglass mesh, for plaster thicknesses of 6 mm and greater applied to heat insulation,

Colour: 10 - white
Fabric dimension: 100 mm
Mesh size: 4 x 4 mm
Grammage: 160 g/m²
Notes:
 Einseitiger Gewebeüberstand von 10 cm am Stabende.

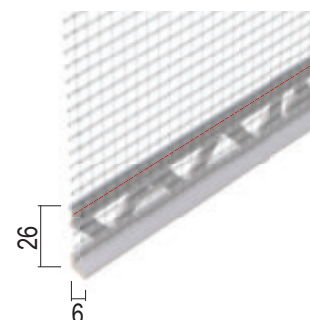

Item number	Insulating boards (mm)	Length (cm)	Order number	Plaster thickness (mm)	Material	Package/ Large pack
37964		250	115169	6 mm	Rigid PVC with glass fibre mesh	50 PCS / 40 BOX

Stop profile for insulation

Stop profile for insulation 20 mm

Material thickness: 0,8 mm

	Item number	Insulating boards (mm)	Length (cm)	Order number	Material	Package/ Large pack
NEW	92322	20	250	119513	Aluminum natural	10 PCS / 100 BUN
NEW	92324	40	250	119512	Aluminum natural	10 PCS / 56 BUN
NEW	92326	60	250	119511	Aluminum natural	10 PCS / 40 BUN
NEW	92328	80	250	119510	Aluminum natural	10 PCS / 32 BUN
NEW	92330	100	250	119509	Aluminum natural	10 PCS / 24 BUN

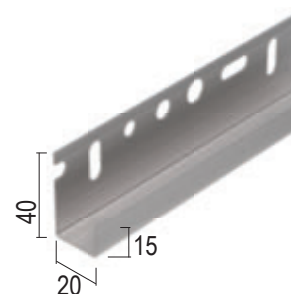

Stop profile for insulation

Stop profile for insulation 20 mm

Material thickness: 0,8 mm
color value: 10 - white

	Item number	Insulating boards (mm)	Length (cm)	Order number	Material	Package/ Large pack
NEW	92422	20	250	119508	Aluminum, with basic coating	10 PCS / 100 BUN
NEW	92424	40	250	119507	Aluminum, with basic coating	10 PCS / 56 BUN
NEW	92426	60	250	119506	Aluminum, with basic coating	10 PCS / 40 BUN
NEW	92428	80	250	119505	Aluminum, with basic coating	10 PCS / 32 BUN
NEW	92430	100	250	119504	Aluminum, with basic coating	10 PCS / 24 BUN

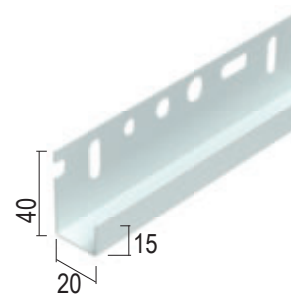

JOINT PROFILES

Expansion joint profile for interior and exterior render

Expansion joint profile made of stainless steel for interior and exterior plastering from 6 mm. Outdoors and in wet rooms only for vertical use.

Movement absorption tension/compression:
+/-5 mm

Notes:
See data sheet for possible profile combinations.

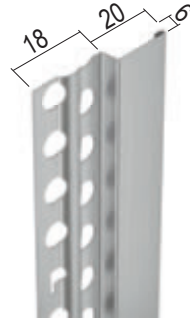

Item number	Plaster thickness (mm)	Length (cm)	Order number	Material	Package/ Large pack
2236	6 mm	250	102498	Stainless steel	25 PCS / 160 BUN

Sliding joint profile for thermal insulation

Clip-on profile for creating plain bearing joints for thermal insulation systems.

Suitable for product: 9181; 2151

Item number	Insulating boards (mm)	Length (cm)	Order number	Plaster thickness (mm)	Material	Package/ Large pack
9182		250	102009	6 mm	Aluminum natural	20 PCS / 126 BUN
2152		250	101406	6 mm	Stainless steel	10 PCS / 200 BUN

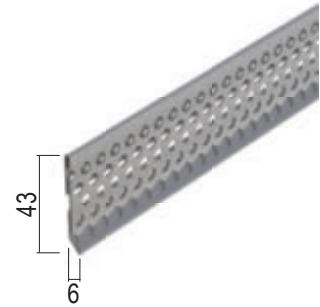

Sliding joint profile for thermal insulation

Profile combination for creating sliding joints on thermal insulation systems.

Suitable for product: 9182; 2152



Item number	Insulating boards (mm)	Length (cm)	Order number	Plaster thickness (mm)	Material	Package/ Large pack
9181		250	102008	6 mm	Aluminum natural	20 PCS / 154 BUN
2151		250	101403	6 mm	Stainless steel	10 PCS / 234 BUN

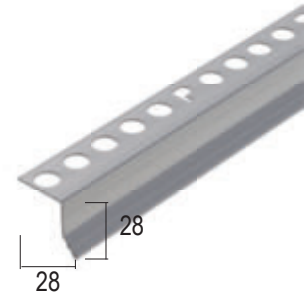

Sliding joint profile for thermal insulation

Plain bearing joint profile - slide-in profile for forming plain bearing joints in ETIC systems, particularly suitable for producing the joint in the case of extensions with a lightweight construction.

Notes:
Profile for subsequent insertion into the plain bearing joint, e.g. between a massive old building and a building extension in lightweight construction.

Item number	Insulating boards (mm)	Length (cm)	Order number	Plaster thickness (mm)	Material	Package/ Large pack
9540		250	115637	6 mm	Aluminum natural	10 PCS / 48 BUN

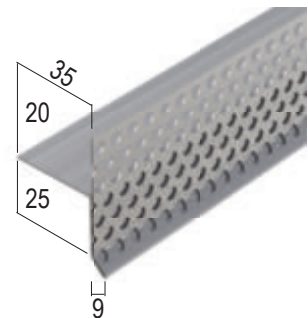

JOINT PROFILES

Sliding joint profile for thermal insulation

Plain bearing joint profile - slide-in profile for forming plain bearing joints in ETIC systems, particularly suitable for producing the joint in the case of extensions with a lightweight construction.

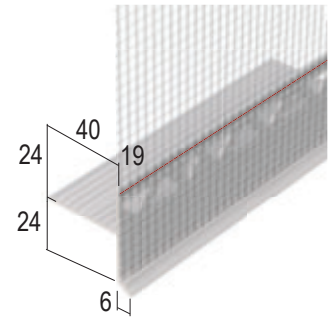

Item number	Insulating boards (mm)	Length (cm)	Order number	Plaster thickness (mm)	Material	Package/ Large pack
37540		250	115994	6 mm	Rigid PVC with glass fibre mesh	15 PCS / 13 BOX

Expansion joint profile for thermal insulation

Expansion joint profile made of hard PVC and loop in the middle part made of soft PVC with alkali-resistant glass fiber fabric for interior and exterior plastering from 6 mm, for use on surfaces. Outdoors and in wet rooms only for vertical use.

Colour: 10 - white

Notes:

One-sided fabric and loop overhang at the end of the rod.

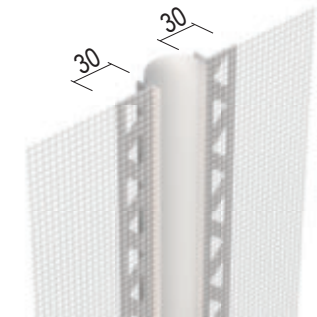

Item number	Insulating boards (mm)	Length (cm)	Order number	Plaster thickness (mm)	Material	Package/ Large pack
30351		250	116300	6 mm	Rigid PVC with soft PVC and glass fibre mesh	10 PCS / 48 BOX
30352		250	116301	10 mm	Rigid PVC with soft PVC and glass fibre mesh	10 PCS / 48 BOX

Expansion joint profile for thermal insulation

Expansion joint profile made of hard PVC and loop in the middle part made of soft PVC with alkali-resistant glass fiber fabric for interior and exterior plastering from 6 mm, for use in the inside corner. Outdoors and in wet rooms only for vertical use.

Colour: 10 - white

Notes:

One-sided fabric and loop overhang at the end of the rod.

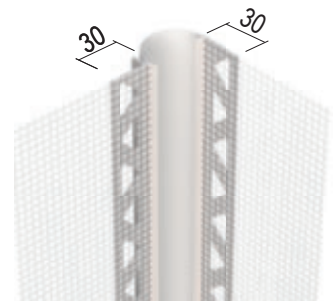

Item number	Insulating boards (mm)	Length (cm)	Order number	Plaster thickness (mm)	Material	Package/ Large pack
30361		250	116302	6 mm	Rigid PVC with soft PVC and glass fibre mesh	10 PCS / 48 BOX
30362		250	116303	10 mm	Rigid PVC with soft PVC and glass fibre mesh	10 PCS / 48 BOX

Expansion joint profile for thermal insulation

Expansion joint profile made of hard PVC and middle part made of soft PVC with alkali-resistant glass fiber fabric for interior and exterior plastering from 6 mm, for use on the surface and in the inside corner. Outdoors and in wet rooms only for vertical use.

Movement absorption tension/compression: +4/-2 mm

Colour: 10 - white

Fabric dimension: 100/100 mm

Mesh size: 4 x 4 mm

Grammage: 160 g/m²

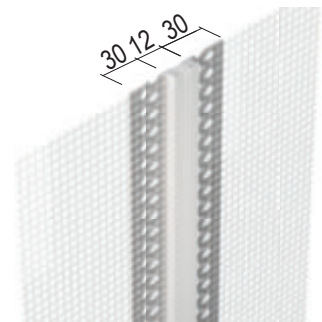

Item number	Insulating boards (mm)	Length (cm)	Order number	Plaster thickness (mm)	Material	Package/ Large pack
37532		300	109538	6 mm	Rigid PVC with soft PVC and glass fibre mesh	10 PCS / 15 BOX

JOINT PROFILES

Expansion joint profile for thermal insulation

Movement joint profile made of hard PVC and middle part made of soft PVC with sewn-on alkali-resistant fiberglass fabric for interior and exterior plastering from 6 mm, for use on the surface and in the inside corner.
Outdoors and in wet rooms only for vertical use.

Movement absorption tension/compression:
+/-1,5 mm

Colour: 10 - white

Fabric dimension: 100/100 mm

Mesh size: 4 x 4 mm

Grammage: 160 g/m²

Notes:

Einseitiger Gewebeüberstand von 10 cm am Stabende.

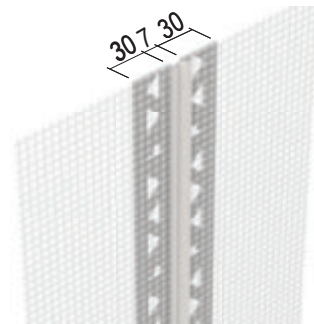

Item number	Insulating boards (mm)	Length (cm)	Order number	Plaster thickness (mm)	Material	Package/ Large pack
37531		275	115761	6 mm	Rigid PVC with soft PVC and glass fibre mesh	10 PCS / 13 BOX

EDGING PROFILES

Edge profile with waterdrip nose and mesh for lathwork board

Frame profile with drip edge made of PVC with alkali-resistant fabric for horizontal use for panel thickness 12.5 mm with 6 mm plaster structure.

Colour: 10 - white

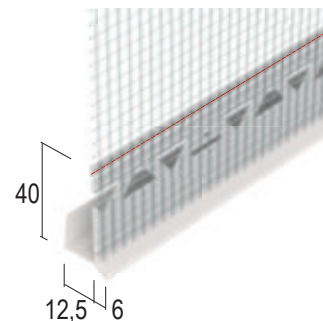

NEW

Item number	Insulating boards (mm)	Length (cm)	Order number	Plaster thickness (mm)	Material	Package/ Large pack
37155		250	118868	6 mm	Rigid PVC with glass fibre mesh	25 PCS / 20 BOX

Edge profile with mesh for Lathwork boards

PVC edging profile with alkali-resistant fabric for panel thickness 12.5 mm with 6 mm plaster structure.

Colour: 10 - white

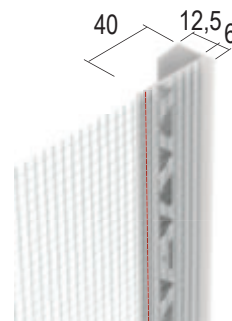

NEW

Item number	Insulating boards (mm)	Length (cm)	Order number	Plaster thickness (mm)	Material	Package/ Large pack
37154		250	118867	6 mm	Rigid PVC with glass fibre mesh	25 PCS / 20 BOX

PROFILES FOR MECHANICAL FIXING

Start profile for mechanical fixed thermal insulation

Start bar made of rigid PVC

Item number	Insulating boards (mm)	Length (cm)	Order number	Plaster thickness (mm)	Material	Package/ Large pack
3759		250	103114		Hard PVC	20 PCS / 24 BOX

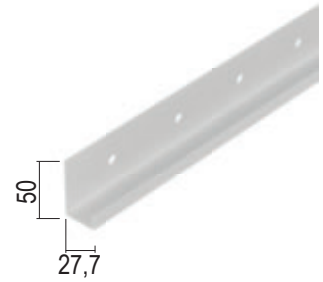

Retaining profile for mechanical fixed thermal insulation

Retaining profile made of rigid PVC for mechanical fixed thermal insulation.

Item number	Insulating boards (mm)	Length (cm)	Order number	Plaster thickness (mm)	Material	Package/ Large pack
3760		250	101761		Hard PVC	25 PCS / 20 BOX

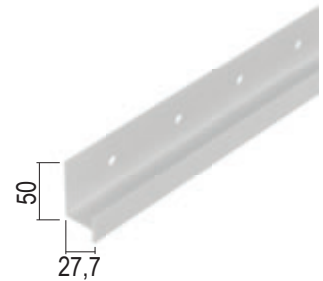

Connecting profile for mechanical fixed thermal insulation

Connection profile made of rigid PVC for mechanical fixed thermal insulation.

Item number	Insulating boards (mm)	Length (cm)	Order number	Plaster thickness (mm)	Material	Package/ Large pack
3761		49	101766		Hard PVC	100 PC / 60 BOX

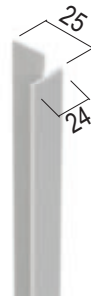

Connecting profile for mechanical fixed thermal insulation

Aluminium Connection profile for mechanical fixed thermal insulation.

Item number	Insulating boards (mm)	Length (cm)	Order number	Plaster thickness (mm)	Material	Package/ Large pack
9115		47	101932		Aluminum natural	100 PC / 40 BOX
9114		59	101906		Aluminum natural	100 PC / 40 BOX



Retaining profile for mechanical fixed thermal insulation

Aluminium retaining profile for mechanical fixed thermal insulation.

Item number	Insulating boards (mm)	Length (cm)	Order number	Plaster thickness (mm)	Material	Package/ Large pack
9116		200	101934		Aluminum natural	25 PCS / 36 BOX

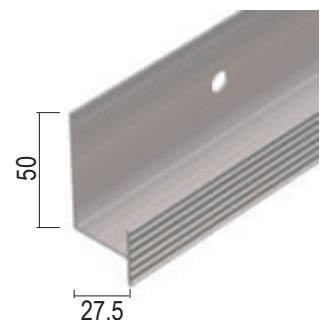

REINFORCEMENT MESH

Glass fibre mesh for thermal insulation

Mesh for the reinforcement of base plasters in outdoor areas. Can be used for surface reinforcement and at transitions of e.g. wall connections, material changes, wall slots, roller shutter boxes, etc.

Mesh size: 4 x 4 mm
Grammage: 160 g/m²
Notes:
 Features: Alkali resistant, displacement-resistant, plasticizer-free.
 Meets the requirements of ETAG 004



Item number	Insulating boards (mm)	Length (cm)	Order number	Plaster thickness (mm)	Material	Package/ Large pack
1492	5	109173			Alkali-resistant glass fibre mesh	50 M / 30 ROL

Glass fibre mesh for thermal insulation

Glass fibre mesh for thermal insulation, printed with the word "PROTEKTOR".
 4 x 4 mm, 145 g/m² white, width 1 m

Mesh size: 4 x 4 mm
Grammage: 145 g/m²



Item number	Insulating boards (mm)	Length (cm)	Order number	Plaster thickness (mm)	Material	Package/ Large pack
1493	5,000	111947			Alkali-resistant glass fibre mesh	50 M / 33 ROL

Glass fibre mesh for thermal insulation

Reinforcement fabric for the reinforcement of mechanically heavily loaded areas in ETICS systems. Tested and certified fabric in accordance with ETAG 004. Can be used for e.g. plinth areas, connections to balconies, terraces, roller shutter boxes, etc.

Notes:
 Features: Alkali resistant, displacement-resistant, plasticizer-free.
 Meets the requirements of ETAG 004
color value: R8 - yellow



Item number	Insulating boards (mm)	Length (cm)	Order number	Plaster thickness (mm)	Material	Package/ Large pack
1494	5	111308			Alkali-resistant glass fibre mesh	50 M / 33 ROL

Glass fibre mesh for thermal insulation

Glass fibre mesh for thermal insulation.
 6 x 6 mm, 160 g/m² white, width 1 m

color value: 10 - white



Item number	Insulating boards (mm)	Length (cm)	Order number	Plaster thickness (mm)	Material	Package/ Large pack
1098	5	109865			Alkali-resistant glass fibre mesh	50 M / 25 ROL

Glass fibre mesh for thermal insulation

Glass fibre mesh for internal plastering.
 Roll width 100 cm, 4 x 4 mm, 75 g/m².



Item number	Insulating boards (mm)	Length (cm)	Order number	Plaster thickness (mm)	Material	Package/ Large pack
14916	5	118637			Alkali-resistant glass fibre mesh	50 M / 20 ROL

PROFILES FOR INSULATING PLASTER

Corner bead for insulating

Corner profile made of galvanised steel with PVC coating for thermal insulation plaster with various plaster thicknesses (a). In the reveal area additionally for different plaster thicknesses variable applicable.

Colour: 10 - white



Item number	Plaster thickness (mm)	Length (cm)	Order number	Material	Package/ Large pack
1063	30 mm	300	100668	Galvanised steel, with PVC coating	15 PCS / 49 BUN
1064	40 mm	300	100678	Galvanised steel, with PVC coating	15 PCS / 35 BUN
1065	50 mm	300	100686	Galvanised steel, with PVC coating	15 PCS / 35 BUN
1066	60 mm	300	100694	Galvanised steel, with PVC coating	15 PCS / 35 BUN

Base stop profile for insulating

Render stops made of galvanised steel with PVC coating for thermal insulation plaster with different plaster thicknesses (a).

Colour: 10 - white
Angular position: 110°

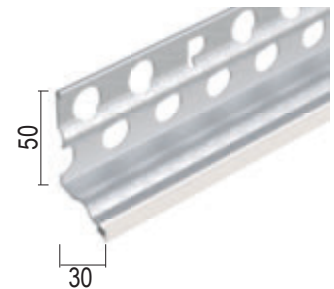

Item number	Plaster thickness (mm)	Length (cm)	Order number	Material	Package/ Large pack
1263	30 mm	300	100975	Galvanised steel, with PVC coating	15 PCS / 63 BUN
1264	40 mm	300	100976	Galvanised steel, with PVC coating	15 PCS / 54 BUN
1265	50 mm	300	100977	Galvanised steel, with PVC coating	15 PCS / 49 BUN
1266	60 mm	300	100978	Galvanised steel, with PVC coating	15 PCS / 55 BUN

Stop profile for insulating

Render stops made of galvanised steel with PVC coating for thermal insulation plaster with different plaster thicknesses (a).

Colour: 10 - white

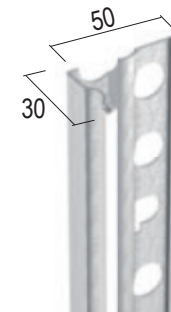

Item number	Plaster thickness (mm)	Length (cm)	Order number	Material	Package/ Large pack
1283	30 mm	300	101019	Galvanised steel, with PVC coating	15 PCS / 55 BUN
1284	40 mm	300	101025	Galvanised steel, with PVC coating	15 PCS / 55 BUN
1285	50 mm	300	101029	Galvanised steel, with PVC coating	15 PCS / 55 BUN
1286	60 mm	300	101035	Galvanised steel, with PVC coating	15 PCS / 55 BUN

Base and lintel stop profile for insulating

Base profiles/window lintels made of galvanised steel with PVC coating for thermal insulation plaster with different plaster thicknesses (a).

Colour: 10 - white

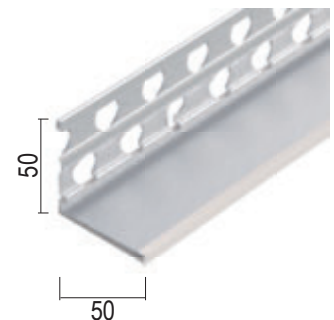

Item number	Plaster thickness (mm)	Length (cm)	Order number	Material	Package/ Large pack
1295	50 mm	300	101052	Galvanised steel, with PVC coating	15 PCS / 40 BUN

SALE

REINFORCING MESH THERMAL INSULATION

Glass fibre mesh ETICS

Mesh for the reinforcement of base plasters in outdoor areas. Can be used for surface reinforcement and at transitions of e.g. wall connections, material changes, wall slots, roller shutter boxes, etc.

Mesh size: 4 x 4 mm

Grammage: 160 g/m²

Notes:

Features: Alkali resistant, displacement-resistant, plasticizer-free.

Meets the requirements of ETAG 004



Item number	Fabric dimension	Order number	Material	Color	Package/ Large pack
14920	100 cm x 50 m	119817	Glass fiber	10 - white	50 M2 / 33 ROL
	110 cm x 50 m	119818	Glass fiber	10 - white	55 M2 / 33 ROL
	100 cm x 50 m	119819	Glass fiber	R8 - yellow	50 M2 / 33 ROL
	100 cm x 50 m	119820	Glass fiber	Z1 - orange	50 M2 / 33 ROL
	100 cm x 50 m	119821	Glass fiber	CD - blue	50 M2 / 33 ROL
	100 cm x 50 m	119822	Glass fiber	T5 - rot	50 M2 / 33 ROL
	100 cm x 50 m	119823	Glass fiber	GN - grün	50 M2 / 33 ROL
	100 cm x 50 m	119824	Glass fiber	G1 - oliv	50 M2 / 33 ROL
	100 cm x 50 m	119825	Glass fiber	BX - bordeaux	50 M2 / 33 ROL

Glass fibre mesh ETICS

Reinforcement fabric for the execution of surface reinforcement in ETICS systems.

Tested and certified fabric according to ETAG 004.

Can also be used outside the system to prevent or remediate cracks in the façade area.

Mesh size: 6 x 6 mm

Grammage: 160 g/m²

Notes:

Features: Alkali resistant, displacement-resistant, plasticizer-free.

Meets the requirements of ETAG 004

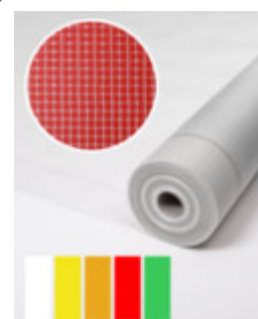

Item number	Fabric dimension	Order number	Material	Color	Package/ Large pack
14921	100 cm x 50 m	119826	Glass fiber	10 - white	50 M2 / 24 ROL
	100 cm x 50 m	119827	Glass fiber	R8 - yellow	50 M2 / 24 ROL
	100 cm x 50 m	119828	Glass fiber	Z1 - orange	50 M2 / 24 ROL
	100 cm x 50 m	119829	Glass fiber	T5 - rot	50 M2 / 24 ROL
	100 cm x 50 m	119830	Glass fiber	GN - grün	50 M2 / 24 ROL

Glass fibre mesh ETICS

Reinforcement fabric for the execution of surface reinforcement in ETICS systems.

Tested and certified fabric according to ETAG 004.

Can also be used outside the system to prevent or remediate cracks in the façade area.

Mesh size: 4 x 4 mm

Grammage: 165 g/m²

Notes:

Features: Alkali resistant, displacement-resistant, plasticizer-free.

Meets the requirements of ETAG 004



Item number	Fabric dimension	Order number	Material	Color	Package/ Large pack
14922	100 cm x 10 m	119831	Glass fiber	10 - white	10 M2 / 125 ROL
	100 cm x 50 m	119832	Glass fiber	10 - white	50 M2 / 33 ROL
	110 cm x 50 m	119833	Glass fiber	10 - white	55 M2 / 33 ROL
	100 cm x 10 m	119834	Glass fiber	BX - bordeaux	10 M2 / 125 ROL
	100 cm x 50 m	119835	Glass fiber	BX - bordeaux	50 M2 / 33 ROL
	100 cm x 10 m	119836	Glass fiber	R8 - yellow	10 M2 / 125 ROL
	100 cm x 50 m	119837	Glass fiber	R8 - yellow	50 M2 / 33 ROL
	100 cm x 10 m	119838	Glass fiber	CD - blue	10 M2 / 125 ROL
	100 cm x 50 m	119839	Glass fiber	CD - blue	50 M2 / 33 ROL

REINFORCING MESH THERMAL INSULATION

Glass fibre mesh ETICS

Reinforcement fabric for the execution of surface reinforcement in ETICS systems.
Tested and certified fabric according to ETAG 004.
Can also be used outside the system to prevent or remediate cracks in the façade area.

Mesh size: 7 x 7 mm
Grammage: 210 g/m²
Notes:
Features: Alkali resistant, displacement-resistant, plasticizer-free.
Meets the requirements of ETAG 004

Item number	Fabric dimension	Order number	Material	Color	Package/ Large pack
14923	100 cm x 50 m	119843	Glass fiber	10 - white	50 M2 / 20 ROL
	100 cm x 50 m	119844	Glass fiber	G1 - oliv	50 M2 / 20 ROL
	100 cm x 50 m	119845	Glass fiber	BX - bordeaux	50 M2 / 20 ROL



Glass fibre mesh ETICS

Reinforcement fabric for the execution of surface reinforcement in ETICS systems.
Tested and certified fabric according to ETAG 004.
Can also be used outside the system to prevent or remediate cracks in the façade area.

Mesh size: 8 x 8 mm
Grammage: 210 g/m²
Notes:
Features: Alkali resistant, displacement-resistant, plasticizer-free.
Meets the requirements of ETAG 004

Item number	Fabric dimension	Order number	Material	Color	Package/ Large pack
14924	100 cm x 50 m	119846	Glass fiber	10 - white	50 M2 / 20 ROL
	100 cm x 50 m	119847	Glass fiber	G1 - oliv	50 M2 / 20 ROL
	100 cm x 50 m	119849	Glass fiber	BX - bordeaux	50 M2 / 20 ROL



Filler and renovation mesh

Reinforcement fabric for the execution of surface reinforcement in ETICS systems.
Tested and certified fabric according to ETAG 004.
Can also be used outside the system to prevent or remediate cracks in the façade area.

Mesh size: 4 x 4 mm
Grammage: 145 g/m²
Notes:
Features: Alkali resistant, displacement-resistant, plasticizer-free.
Meets the requirements of ETAG 004

Item number	Fabric dimension	Order number	Material	Color	Package/ Large pack
14925	100 cm x 50 m	119850	Glass fiber	10 - white	50 M2 / 33 ROL



Armor mesh

Reinforcement fabric for the reinforcement of mechanically heavily loaded areas in ETICS systems. Tested and certified fabric in accordance with ETAG 004. Can be used for e.g. plinth areas, connections to balconies, terraces, roller shutter boxes, etc.

Mesh size: 6 x 6 mm
Grammage: 330 g/m²
Notes:
Features: Alkali resistant, displacement-resistant, plasticizer-free.
Meets the requirements of ETAG 004

Item number	Fabric dimension	Order number	Material	Color	Package/ Large pack
14926	100 cm x 25 m	119851	Glass fiber	10 - white	25 M2 / 33 ROL



REINFORCING MESH THERMAL INSULATION

Armor mesh

Reinforcement fabric for the reinforcement of mechanically heavily loaded areas in ETICS systems. Tested and certified fabric in accordance with ETAG 004. Can be used for e.g. plinth areas, connections to balconies, terraces, roller shutter boxes, etc.

Mesh size: 6 x 8 mm
Grammage: 330 g/m²
Notes:
 Features: Alkali resistant, displacement-resistant, plasticizer-free.
 Meets the requirements of ETAG 004



Item number	Fabric dimension	Order number	Material	Color	Package/ Large pack
14927	100 cm x 25 m	119852	Glass fiber	10 - white	25 M2 / 33 ROL

Diagonal reinforcement ETICS

Glass fibre mesh for thermal insulation. 4 x 5 mm, 160 g/m² yellow, width 1,1 m

Fabric dimension: 330 x 400 mm
Mesh size: 4 x 4 mm
Grammage: 165 g/m²



Item number	Width (mm)	Length (cm)	Order number	Material	Color	Package/ Large pack
14940		40	119699	Glass fiber	10 - white	100 PC / 60 BOX
14941		40	119706	Glass fiber	10 - white	10 PC / 120 BOX

Diagonal reinforcement ETICS

Glass fibre mesh for thermal insulation. 4 x 5 mm, 160 g/m² yellow, width 1,1 m

Fabric dimension: 330 x 400 mm
Mesh size: 7 x 7 mm
Grammage: 200 g/m²



Item number	Width (mm)	Length (cm)	Order number	Material	Color	Package/ Large pack
14942		40	119707	Glass fiber	10 - white	100 PC / 60 BOX
14943		40	119708	Glass fiber	10 - white	10 PC / 120 BOX

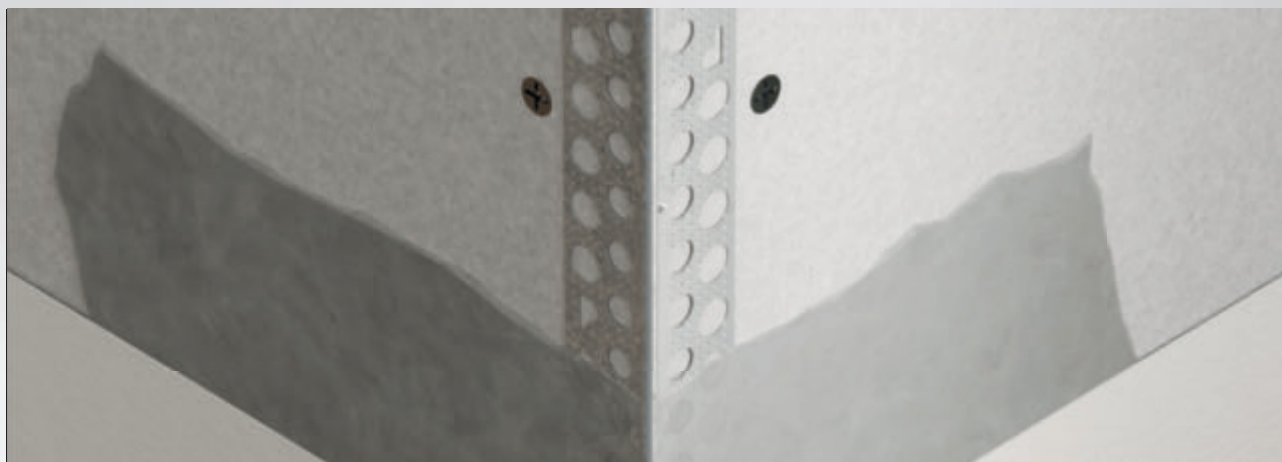

GENERAL INFORMATION

- ▶ For internal finishing, trowel profiles made of metal (steel, aluminum, stainless steel), plastic or composite profiles are used for edges, connections and terminations, edgings, movement joints or creative designs.
- ▶ Our paper-flocked or paper-laminated composite profiles ensure a particularly precise and fast filling result in dry construction, with minimal filling consumption.
- ▶ They are extremely resilient and impact-resistant and can be used as roll material for all edge and angle positions.
- ▶ The water-activated, self-adhesive WET profiles are set without additional filler or mechanical fastening.
- ▶ Setting the filler profiles is even faster with the NEW Protektor spray adhesive!
- ▶ Cut metal profiles with hand shears. Never cut galvanized profiles with a cutting disc. Process stainless steel profiles only with rustproof tools and cut with a cutting disc recommended for stainless steel. Cut PVC profiles to the required installation dimension using suitable PVC shears (e.g. Protektor profile shears).
- ▶ Fill in both sides of the edge profiles all the way to the head. Place edge and end profiles on factory-bevelled GRP edges or chamfer cut edges.
- ▶ Edge profiles, connecting profiles and stop profiles, which are applied to the GRP panels, must be embedded in the filler over the entire surface.
- ▶ Do not overfill metal or PVC edging profiles, only apply filler.
- ▶ Expansion and movement joint profiles must be mechanically fixed by means of staples or screws in addition to the filler fastening.
- ▶ It is advisable to store rolled PVC profiles at room temperature $\geq 18\text{ °C}$ in winter to facilitate the processing.
- ▶ Store all profiles in a dry place! Additionally, store PVC profiles in a cool and frost-free place, horizontal and flat lying.

All standards and guidelines on the subject of plaster and drywall must be observed in their current version, in particular the following leaflet:

- Leaflet for the planning and application of metallic plaster profiles in external and internal areas from the European Association of Plaster Profile Manufacturers.

The product information as well as the additional information with the respective product illustrations in this catalogue and the further notes in our product data sheets and processing instructions on our homepage must be observed! For the selection of metallic plaster profiles, please refer to the table for profile selection according to mortar types.

The VOB mark of Protektor - quality that pays off. Protektor trowel profiles with the blue sign meet the requirements of the VOB and can be invoiced as special services. So with the blue sign on your side, you can easily find the right profile to deliver quality and receive performance.



CORNER PROFILES

Corner bead for dry lining

Galvanised steel corner profiles for jointing on plasterboard edges.

Notes:
With a 3D surface structure for increased profile stability and improved plaster embedding.

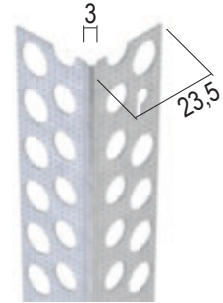

Item number	Plaster thickness (mm)	Length (cm)	Order number	Material	Package/ Large pack
1030	1 mm	250	117431	Galvanised steel	30 PCS / 160 BUN
	1 mm	300	117435	Galvanised steel	30 PCS / 140 BUN

Corner bead for dry lining

Galvanised steel corner profiles for jointing on plasterboard edges.
With long plastering leg for covering tears along cut edges.

Notes:
With a 3D surface structure for increased profile stability and improved plaster embedding.

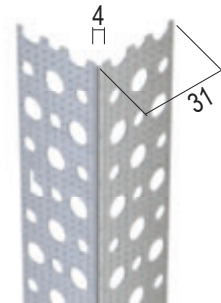

Item number	Plaster thickness (mm)	Length (cm)	Order number	Material	Package/ Large pack
1078	1 mm	250	112221	Galvanised steel	25 PCS / 90 BUN
	1 mm	300	112222	Galvanised steel	25 PCS / 90 BUN

CORNER PROFILES

Corner bead for dry lining

Aluminium corner profiles for jointing on plasterboard edges.

Material thickness (mm): 0,35 mm

Stainless steel version: 1031

Notes:

With a 3D surface structure for increased profile stability and improved plaster embedding. The profile is not CE conform.

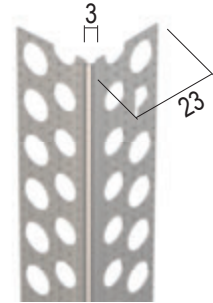

Item number	Plaster thickness (mm)	Length (cm)	Material thickness (mm)	Order number	Material	Package/ Large pack
9579	1 mm	200	0,35 mm	108546	Aluminum natural	50 PCS / 136 BUN
	1 mm	250	0,35 mm	106172	Aluminum natural	50 PCS / 136 BUN
	1 mm	275	0,35 mm	106228	Aluminum natural	50 PCS / 136 BUN
	1 mm	300	0,35 mm	106173	Aluminum natural	50 PCS / 136 BUN
9079	1 mm	200	0,4 mm	106952	Aluminum natural	50 PCS / 136 BUN
	1 mm	250	0,4 mm	106950	Aluminum natural	50 PCS / 136 BUN
	1 mm	275	0,4 mm	106953	Aluminum natural	50 PCS / 136 BUN
	1 mm	300	0,4 mm	106954	Aluminum natural	50 PCS / 136 BUN
9078	1 mm	200	0,45 mm	106955	Aluminum natural	50 PCS / 136 BUN
	1 mm	250	0,45 mm	106956	Aluminum natural	50 PCS / 136 BUN
	1 mm	275	0,45 mm	106957	Aluminum natural	50 PCS / 136 BUN
	1 mm	300	0,45 mm	106958	Aluminum natural	50 PCS / 136 BUN

Corner bead for dry lining

Aluminium corner profiles with white case coat for jointing on plasterboard edges.

Colour: 10 - white

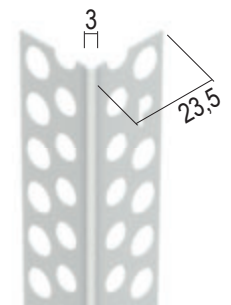

Item number	Plaster thickness (mm)	Length (cm)	Order number	Material	Package/ Large pack
9278	1 mm	250	102032	Aluminum, with basic coating	50 PCS / 126 BUN

Corner bead for dry lining

Stainless steel corner profile for filler and thin-layer plaster of 1 mm and thicker in interior areas.

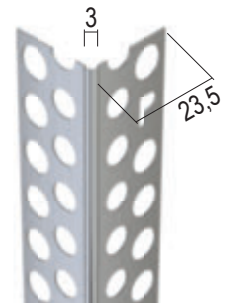

Item number	Plaster thickness (mm)	Length (cm)	Order number	Material	Package/ Large pack
1031	1 mm	250	117438	Stainless steel	30 PCS / 160 BUN
	1 mm	260	117439	Stainless steel	30 PCS / 140 BUN
	1 mm	300	117440	Stainless steel	30 PCS / 140 BUN

CORNER PROFILES

Corner bead 135° for dry lining

Aluminium corner profiles for jointing on plaster-board edges. Profile for 135° corner execution.

Rounding off radius: 2,75 mm

Notes:

Specially developed for schools and kindergartens. Satisfies the german guidelines and requirements of the statutory accident prevention regulations. See technical information.

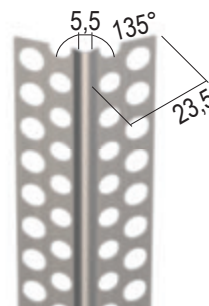

Item number	Plaster thickness (mm)	Length (cm)	Order number	Material	Package/ Large pack
9172	1 mm	250	101988	Aluminum natural	50 PCS / 180 BUN
	1 mm	300	101990	Aluminum natural	50 PCS / 150 BUN

Corner bead for dry lining

Aluminium corner profile, with an extra-long plastering leg, for joining on plasterboard panels, providing greater stability and preventing cracks in the cut edge area.

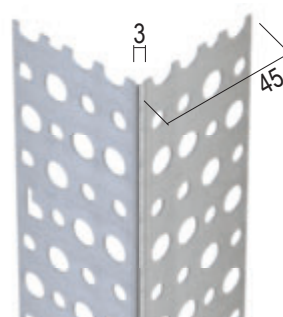

Item number	Plaster thickness (mm)	Length (cm)	Order number	Material	Package/ Large pack
9179	1 mm	250	102002	Aluminum natural	25 PCS / 108 BUN
	1 mm	300	102005	Aluminum natural	25 PCS / 108 BUN

Corner bead for dry lining

Corner profile made of aluzinc steel, for plaster of 2 mm in the interior.

Processing instructions: Placed and fixed in a mortar bed, if necessary to fix with additional clips.

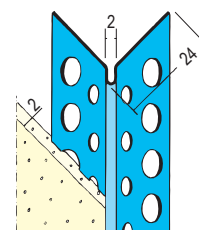

Item number	Plaster thickness (mm)	Length (cm)	Order number	Material	Package/ Large pack
1033	2 mm	250	109281	Steel, aluzinc	25 PCS / 150 BUN
	2 mm	260	109282	Steel, aluzinc	25 PCS / 150 BUN
	2 mm	300	109283	Steel, aluzinc	25 PCS / 150 BUN

Corner bead for dry lining

Edge profiles made of PVC for jointing on plaster-board edges. With the narrow head allowed a forming sharp and precise edges.

Notes:

All profiles must also be fastened with clips.

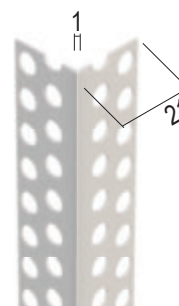

Item number	Plaster thickness (mm)	Length (cm)	Order number	Material	Package/ Large pack
37171	1 mm	260	114247	Hard PVC	100 PCS / 36 BOX
	1 mm	300	114494	Hard PVC	100 PCS / 36 BOX

CORNER PROFILES

Flexible corner bead for dry lining

PVC corner beads on roles for plastering work. "Kink joints" allow application on obtuse and acute angled plasterboard edges. The profiles must also be fastened with galvanised clips.

Colour: 10 - white

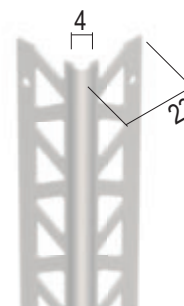

Item number	Plaster thickness (mm)	Length (cm)	Order number	Material	Package/ Large pack
3751	1 mm	5	103773	Hard PVC	2 ROL / 52 BOX

Flexible inside corner bead for dry lining

PVC inside corner profile for creating gypsum corners. Universal applications thanks to "kink folds" for angles of 70° to 135°.

Colour: 10 - white

Notes:
Trim-Tex 4310
Adjustable Inside Corner Bead



Item number	Plaster thickness (mm)	Length (cm)	Order number	Material	Package/ Large pack
3770	1 mm	305	102585	Hard PVC	70 PCS / 80 BOX

Corner bead for dry lining

PVC edge profile with fine sharp-tipped head for high-quality plaster work.

Colour: 10 - white

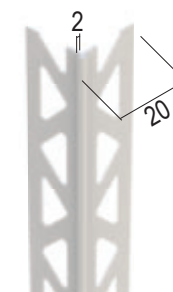

Item number	Plaster thickness (mm)	Length (cm)	Order number	Material	Package/ Large pack
3790	2 mm	260	105611	Hard PVC	60 PCS / 36 BOX

Corner bead for dry lining

Edge profile made of PVC for filling plasterboard edges.

Notes:
Trim-Tex 31610
3/16" Small Bullnose

Specially developed for schools and kindergartens. Meets the guidelines and requirements of the statutory accident prevention regulations (see technical information).



Item number	Plasterboards (mm)	Length (cm)	Order number	Colour	Material	Package/ Large pack
NEW 37651		305	119543	10 - white	Hard PVC	50 PCS / 80 BOX

CORNER PROFILES

Inside corner bead for dry lining

PVC inside corner profile for plastering plasterboard panels. For creating channels within inside corners.

Colour: 10 - white
Rounding off radius: 19 mm
Notes:
 Trim-Tex 7210
 3/4" Radius bullnose inside corner bead

Satisfies the guidelines and requirements specified by the statutory accident prevention regulations. See technical information.



Item number	Plaster thickness (mm)	Length (cm)	Order number	Material	Package/ Large pack
3780	2 mm	305	102612	Hard PVC	35 PCS / 80 BOX

Corner bead for dry lining

PVC corner profiles for creating plasterboard edges. Plasterboard panel edges must be attached.

Colour: 10 - white
Rounding off radius: 19 mm
Notes:
 Trim-Tex 7010
 3/4" Large Bullnose 10'

Satisfies the guidelines and requirements specified by the statutory accident prevention regulations. See technical information.

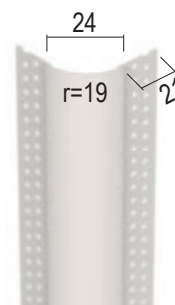

Item number	Plaster thickness (mm)	Length (cm)	Order number	Material	Package/ Large pack
3776	2 mm	305	102598	Hard PVC	35 PCS / 80 BOX

Corner bead for dry lining

PVC corner profile with indentation on one side to create plasterboard edges. For creating curved plasterboard constructions. Plasterboard panel edges must be attached.

Colour: 10 - white
Rounding off radius: 19 mm
Notes:
 Trim-Tex 7110
 3/4" Large Bullnose Archway

Minimum bend radius > 30 cm.
 Satisfies the guidelines and requirements specified by the statutory accident prevention regulations. See technical information.



Item number	Plaster thickness (mm)	Length (cm)	Order number	Material	Package/ Large pack
3778	3 mm	305	102609	Hard PVC	35 PCS / 80 BOX

CORNER PROFILES

Corner bead for dry lining

PVC corner profile, with an extra-long plastering leg, for joining on plasterboard panels, providing greater stability and preventing cracks in the cut edge area. With sharp-tipped head for creating sharp corners.

Colour: 10 - white
Notes:
 Trim-Tex RJ10LP
 Rigid Jumbo Corner Bead 10'

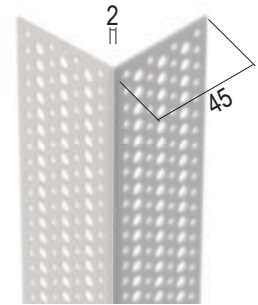

Item number	Plaster thickness (mm)	Length (cm)	Order number	Material	Package/ Large pack
37172	2 mm	305	114399	Hard PVC	45 PCS / 63 BOX

Corner bead for dry lining

PVC corner profile, with an self-adhesive plastering leg, for joining on plasterboard panels.

Colour: 10 - white

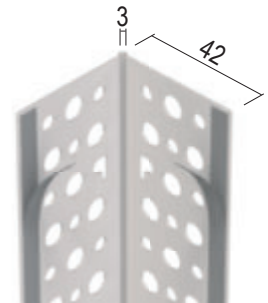

Item number	Plaster thickness (mm)	Length (cm)	Order number	Material	Package/ Large pack
37169	2 mm	250	115783	Hard PVC	50 PCS / 15 BOX

Wallpaper corner bead

Wallpaper edge profile made of PVC for fibreglass or textured wallpaper. With one-sided predetermined breaking point on the profile leg, for use as a wallpaper edge finish.

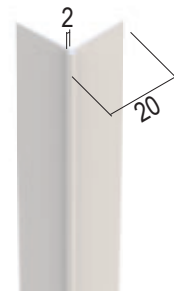

Item number	Plaster thickness (mm)	Length (cm)	Order number	Material	Package/ Large pack
3840	2 mm	260	102482	Hard PVC	60 PCS / 36 BOX

Corner bead for dry lining

PVC corner profile with long plastering leg for covering up tears along the cutting edge. The profiles must also be fastened with clips.

Colour: 10 - white
Rounding off radius: 2,5 mm
Notes:
 Trim-Tex 4010
 Corner Bead 10'

Satisfies the guidelines and requirements specified by the statutory accident prevention regulations. See technical information.

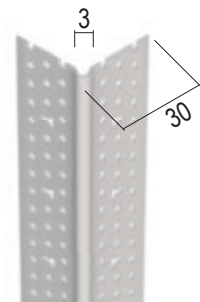

Item number	Plaster thickness (mm)	Length (cm)	Order number	Material	Package/ Large pack
3763	3 mm	305	108872	Hard PVC	50 PCS / 80 BOX

CORNER PROFILES

Corner bead for dry lining

PVC corner profile, cut along one side, with a long plastering leg for covering up tears along the cutting surface and creating plasterboard edges. For creating curved plasterboard constructions.

Colour: 10 - white
Rounding off radius: 2,5 mm
Notes:
 Trim-Tex 4110
 Archway Corner Bead

Minimum bend radius > 30 cm.
 Satisfies the guidelines and requirements specified by the statutory accident prevention regulations. See technical information.

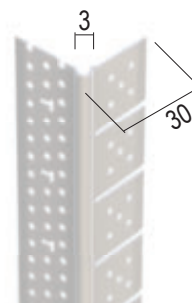

Item number	Plaster thickness (mm)	Length (cm)	Order number	Material	Package/ Large pack
3767	3 mm	300	102569	Hard PVC	20 PCS / 182 BOX

Corner bead for dry lining

Edge profile with a radius of 9.5 mm and extra long legs, for a filler thickness of 3 mm.

Notes:
 Trim-Tex 35010
 3/8" Medium Bullnose 10'
color value: 10 - white



Item number	Plaster thickness (mm)	Length (cm)	Order number	Material	Package/ Large pack
8058	1 mm	305	103602	Hard PVC	35 PCS / 80 BOX

Corner bead for dry lining

Notes:
 Trim-Tex 35020
 3/8" Medium Bullnose Archway
color value: 10 - white



Item number	Plaster thickness (mm)	Length (cm)	Order number	Material	Package/ Large pack
8060		305	110434		25 PCS / 96 BOX

PLASTER STOP PROFILES

Stop profile for dry lining

Stop profile with filler perforation for 9.5-mm-thick plasterboard.

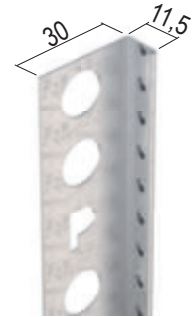

Item number	Plasterboards (mm)	Length (cm)	Order number	Material	Package/ Large pack
1135	9,5 mm	250	100734	Galvanised steel	25 PCS / 140 BUN
	9,5 mm	300	100740	Galvanised steel	25 PCS / 140 BUN
1131	12,5 mm	250	100684	Galvanised steel	25 PCS / 90 BUN
	12,5 mm	300	100698	Galvanised steel	25 PCS / 80 BUN
1132	15 mm	250	100703	Galvanised steel	25 PCS / 90 BUN
	15 mm	300	100709	Galvanised steel	25 PCS / 80 BUN

Stop profile for dry lining

“Göppinger” aluminium profile for creating single edges at plastered junctions, e.g. sliding ceiling wall connections, for 9.5-mm plasterboard sheets.

Notes:
With a 3D surface structure for increased profile stability and improved plaster embedding.



Item number	Plasterboards (mm)	Length (cm)	Order number	Material	Package/ Large pack
9298	9,5 mm	250	102147	Aluminum natural	50 PCS / 250 BUN

Stop profile for dry lining

Stop profile with filler perforation for 12.5-mm-thick plasterboard.

Colour: 10 - white



Item number	Plasterboards (mm)	Length (cm)	Order number	Material	Package/ Large pack
11311	12,5 mm	300	107370	Galvanised steel, with white basic coating	25 PCS / 80 BUN

Stop profile for dry lining

“Göppinger” profile made of galvanised steel for creating single edges at plastered junctions, e.g. sliding ceiling and wall connections, for plasterboard sheets of 12.5 mm and thicker.

Notes:
With a 3D surface structure for increased profile stability and improved plaster embedding.



Item number	Plasterboards (mm)	Length (cm)	Order number	Material	Package/ Large pack
1234	12,5 mm	250	102658	Galvanised steel	20 PCS / 210 BUN
	12,5 mm	275	102766	Galvanised steel	20 PCS / 210 BUN
	12,5 mm	300	102712	Galvanised steel	20 PCS / 210 BUN

PLASTER STOP PROFILES

Stop profile for dry lining

Edge and stop profile for double edging with 2 x 12.5 plasterboard panels.

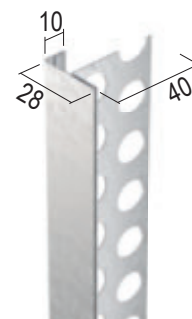

Item number	Plasterboards (mm)	Length (cm)	Order number	Material	Package/ Large pack
1138	12,5 mm	250	100752	Galvanised steel	15 PCS / 55 BUN

Stop profile for dry lining

“Göppinger” profile made of aluminium for creating single edges at plastered junctions, e.g. sliding ceiling and wall connections, for plasterboard sheets of 12.5 mm and thicker.

Material thickness: 0,35 mm

Notes:

With a 3D surface structure for increased profile stability and improved plaster embedding. With a material thickness of 0.35 mm, the profile is not CE conform.

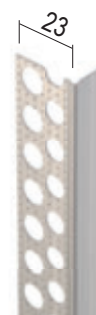

Item number	Plasterboards (mm)	Length (cm)	Material thickness (mm)	Order number	Material	Package/ Large pack
9599	12,5 mm	250	0,35 mm	106170	Aluminum natural	50 PCS / 200 BUN
	12,5 mm	275	0,35 mm	119350	Aluminum natural	50 PCS / 200 BUN
	12,5 mm	300	0,35 mm	106171	Aluminum natural	50 PCS / 200 BUN
9299	12,5 mm	250	0,4 mm	102150	Aluminum natural	50 PCS / 200 BUN
	12,5 mm	300	0,4 mm	102152	Aluminum natural	50 PCS / 200 BUN

Stop profile for dry lining

Stop profile made of aluzinc steel 12.5 mm for plastering into drywall construction. Use profiles in accordance with data sheet “Planning and Application”.

Gypsum plasterboards: 12,5 mm

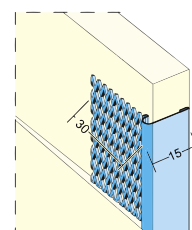

Item number	Plaster thickness (mm)	Length (cm)	Order number	Material	Package/ Large pack
10883	2 mm	305	115337	Steel, aluzinc	50 PCS / 65 BOX

Stop profile for dry lining

Stop profile with filler perforation for 15-mm-thick plasterboard.

Colour: 10 - white



Item number	Plasterboards (mm)	Length (cm)	Order number	Material	Package/ Large pack
11321	15 mm	300	107529	Galvanised steel, with white basic coating	25 PCS / 80 BUN

PLASTER STOP PROFILES

Stop profile for dry lining

“Göppinger” aluminium profile for creating single edges at plastered junctions, e.g. sliding ceiling wall connections, for 15-mm plasterboard sheets.

Notes:
With a 3D surface structure for increased profile stability and improved plaster embedding.



Item number	Plasterboards (mm)	Length (cm)	Order number	Material	Package/ Large pack
9297	15 mm	250	106345	Aluminum natural	50 PCS / 275 BUN

Stop profile for dry lining

Stop profile with filler perforation for 18-mm-thick plasterboard.

Stainless steel version: 2233



Item number	Plasterboards (mm)	Length (cm)	Order number	Material	Package/ Large pack
1133	18 mm	250	100713	Galvanised steel	25 PCS / 120 BUN
	18 mm	300	100718	Galvanised steel	25 PCS / 120 BUN

Stop profile for dry lining

Stop profile with filler perforation for 20-mm-thick plasterboard.

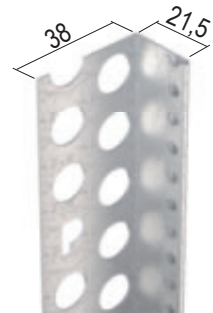

Item number	Plasterboards (mm)	Length (cm)	Order number	Material	Package/ Large pack
1134	20 mm	250	100722	Galvanised steel	25 PCS / 120 BUN
	20 mm	300	100729	Galvanised steel	25 PCS / 120 BUN

Stop profile for dry lining

“Göppinger” profile made of aluminium for creating single edges at plastered junctions, e.g. sliding ceiling and wall connections, for plasterboard panels of 25 mm and thicker (2 x 12.5 mm)

Notes:
With a 3D surface structure for increased profile stability and improved plaster embedding.



Item number	Plasterboards (mm)	Length (cm)	Order number	Material	Package/ Large pack
9002	25 mm	250	102919	Aluminum natural	50 PCS / 150 BUN

Stop profile for dry lining

Stop profile with filler perforation for 25-mm-thick plasterboard.

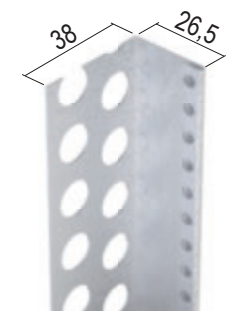

Item number	Plasterboards (mm)	Length (cm)	Order number	Material	Package/ Large pack
1136	25 mm	250	100744	Galvanised steel	25 PCS / 80 BUN
	25 mm	300	100748	Galvanised steel	25 PCS / 65 BUN

PLASTER STOP PROFILES

Connecting profile for plaster

The new aluminium cornice profile with a white base coating is a unique solution for creating a perfect transition from the ceiling grid to a smooth frieze edging that encompasses all four walls, for example. Simply clip on and tighten; there is no need to create a complex replacement structure.

Colour: 10 - white

Notes:

Simple plugging and screwing replaces complex replacement designs.

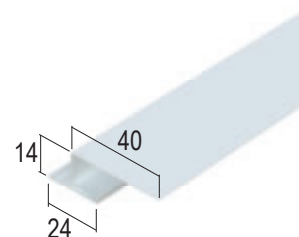

Item number	Plasterboards (mm)	Length (cm)	Order number	Material	Package/ Large pack
9272		250	110320	Aluminum, with basic coating	15 PCS / 50 BUN

Stop profile for dry lining

PVC corner profile, cut along one side, for creating ceiling edges along curved walls. Universally applicable for panels with a thickness of 10 mm and 12.5 mm thanks to the pre-defined breaking point.

Colour: 10 - white

Notes:

Minimum bend radius > 30 cm.

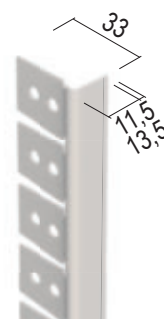

Item number	Plasterboards (mm)	Length (cm)	Order number	Material	Package/ Large pack
3768	9,5 / 12,5 mm	300	102575	Hard PVC	20 PCS / 182 BOX

Stop profile for dry lining

Stop profile made of PVC for creating single plastered junctions. Also available with removable protective strips for guard building elements against dirt.

Colour: 10 - white

Notes:

Trim-Tex 9000
Flat Tear Away® L Bead

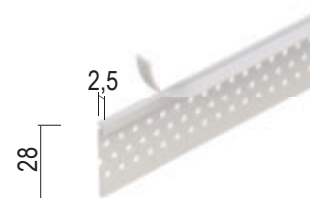

NEW

Item number	Plasterboards (mm)	Length (cm)	Order number	Material	Package/ Large pack
37862		305	118485	Hard PVC	50 PCS / 140 BOX

Stop profile for dry lining

"Göppinger profile" made of PVC for creating single plastered junctions. Also available with removable protective strips for guard building elements against dirt.

Colour: 10 - white

Notes:

Trim-Tex 9010
½" Tear Away 10'

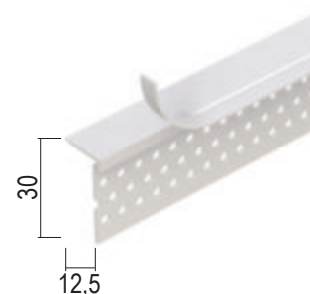

Item number	Plasterboards (mm)	Length (cm)	Order number	Material	Package/ Large pack
3785	12,5 mm	305	108879	Hard PVC	50 PCS / 80 BOX

PLASTER STOP PROFILES

Stop profile for dry lining

"Göppinger profile" made of PVC for creating single plastered junctions.

Colour: 10 - white
Notes:
 Trim-Tex AS3210
 ½" L Bead

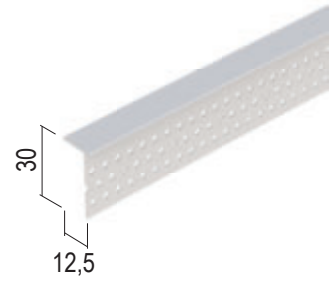

Item number	Plasterboards (mm)	Length (cm)	Order number	Material	Package/ Large pack
37864	12,5 mm	305	115341	Hard PVC	80 PCS / 80 BOX
37865	15 mm	305	115342	Hard PVC	80 PCS / 80 BOX

Curved wall connecting profile for dry lining

PVC angle for creating curved connections on mineral fibre ceilings, such as for round columns or walls.

Colour: 10 - white
Notes:
 Trim-Tex 8158
 7/8" Flex Grid Angle

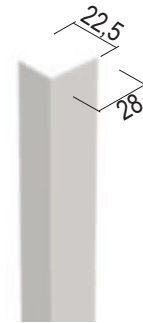

Item number	Plasterboards (mm)	Length (cm)	Order number	Material	Package/ Large pack
3769		250	102578	Hard PVC	10 PCS / 182 BOX

SHADOW JOINT PROFILES

Connecting profile for dry lining

Stop profile made of galvanised steel for assemblies underneath plasterboard panels, with a 10-mm shadow joint. For creating plastered single edges at junctions, e.g. sliding walls and ceiling connections, for 9.5-mm plasterboard panels.

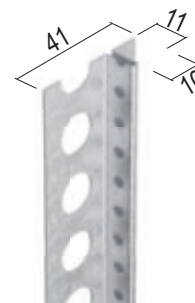

Item number	Plasterboards (mm)	Length (cm)	Shadow gap	Order number	Material	Package/ Large pack
1316	9,5 mm	250	10 mm	101196	Galvanised steel	15 PCS / 99 BUN
	9,5 mm	300	10 mm	101212	Galvanised steel	15 PCS / 99 BUN
1314	12,5 mm	250	10 mm	101150	Galvanised steel	15 PCS / 95 BUN
	12,5 mm	300	10 mm	101156	Galvanised steel	15 PCS / 95 BUN

Connecting profile for dry lining

Stop profile made of galvanised steel for assemblies underneath plasterboard panels, with a 15-mm shadow joint (closed). For creating plastered single edges at plastered junctions, e.g. sliding ceiling and wall connections, for 12.5-mm plasterboard panels.

Stainless steel version: 2241

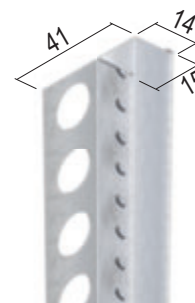

Item number	Plasterboards (mm)	Length (cm)	Shadow gap	Order number	Material	Package/ Large pack
1311	12,5 mm	300	15 mm	109445	Galvanised steel	15 PCS / 108 BUN

Connecting profile for dry lining

Stop profile made of galvanised steel with white base coat for assemblies underneath plasterboard panels, with a 20-mm shadow joint. For creating plastered single edges at plastered junctions, e.g. sliding ceiling and wall connections, for 12.5-mm plasterboard panels.

Colour: 10 - white
Stainless steel version: 2263

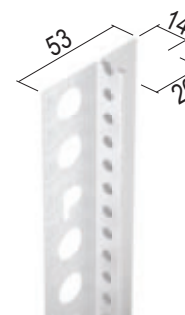

Item number	Plasterboards (mm)	Length (cm)	Shadow gap	Order number	Material	Package/ Large pack
13131	12,5 mm	300	20 mm	108508	Galvanised steel, with white basic coating	15 PCS / 69 BUN

Connecting profile for dry lining

Stop profile made of galvanised steel for assemblies underneath plasterboard panels, with a 10-mm shadow joint. For creating plastered single edges at plastered junctions, e.g. sliding ceiling and wall connections, for 12.5-mm plasterboard panels.

color value: 10 - white

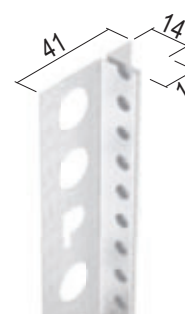

Item number	Plasterboards (mm)	Length (cm)	Shadow gap	Order number	Material	Package/ Large pack
13141	12,5 mm	300	10 mm	109163	Galvanised steel, with white basic coating	15 PCS / 95 BUN

SHADOW JOINT PROFILES

Connecting profile for dry lining

Stop profile made of galvanised steel for assemblies underneath plasterboard panels, with a 15-mm shadow joint. For creating plastered single edges at plastered junctions, e.g. sliding ceiling and wall connections, for 12.5-mm plasterboard panels.

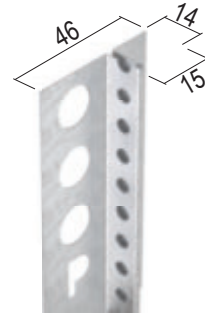

Item number	Plasterboards (mm)	Length (cm)	Shadow gap	Order number	Material	Package/ Large pack
1319	12,5 mm	250	15 mm	101255	Galvanised steel	15 PCS / 88 BUN
	12,5 mm	300	15 mm	101260	Galvanised steel	15 PCS / 88 BUN

Connecting profile for dry lining

Stop profile made of galvanised steel with white base coating for assemblies underneath plasterboard panels, with a 15-mm shadow joint. For creating plastered single edges at plastered junctions, e.g. sliding ceiling and wall connections, for 12.5-mm plasterboard panels.

color value: 10 - white

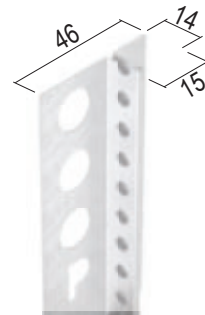

Item number	Plasterboards (mm)	Length (cm)	Shadow gap	Order number	Material	Package/ Large pack
13191	12,5 mm	300	15 mm	108256	Galvanised steel, with white basic coating	15 PCS / 88 BUN

Connecting profile for dry lining

Stop profile made of galvanised steel for assemblies underneath plasterboard panels, with a 4-mm shadow joint. For creating plastered single edges at plastered junctions, e.g. sliding ceiling and wall connections, for 12.5-mm plasterboard panels.



Item number	Plasterboards (mm)	Length (cm)	Shadow gap	Order number	Material	Package/ Large pack
1371	12,5 mm	250	4 mm	101354	Galvanised steel	15 PCS / 128 BUN
	12,5 mm	300	4 mm	101370	Galvanised steel	15 PCS / 112 BUN

Connecting profile for dry lining

Stop profile made of galvanised steel for assemblies underneath plasterboard panels, with a 6-mm shadow joint. For creating plastered single edges at plastered junctions, e.g. sliding ceiling and wall connections, for 12.5-mm plasterboard panels.

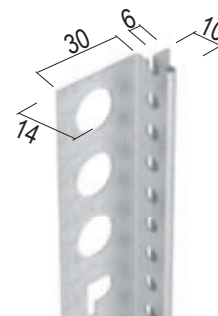

Item number	Plasterboards (mm)	Length (cm)	Shadow gap	Order number	Material	Package/ Large pack
1373	12,5 mm	300	6 mm	108512	Galvanised steel	10 PCS / 216 BUN

Connecting profile for dry lining

Galvanised steel render stop with 20-mm shadow joint. For creating plastered single edges at plastered junctions, e.g. sliding ceiling and wall connections, for 12.5-mm plasterboard panels.

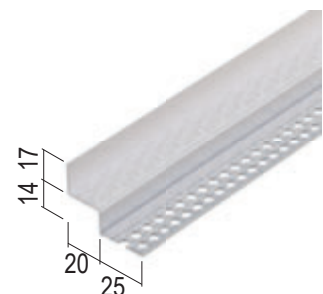

Item number	Plasterboards (mm)	Length (cm)	Shadow gap	Order number	Material	Package/ Large pack
1750	12,5 mm	300	20 mm	106753	Galvanised steel	20 PCS / 72 BUN

SHADOW JOINT PROFILES

Connecting profile for dry lining

Galvanised steel render stop with 20-mm shadow joint. For creating plastered single edges at plastered junctions, e.g. sliding ceiling and wall connections, for 12.5-mm plasterboard panels.

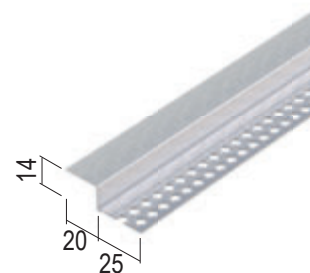

Item number	Plasterboards (mm)	Length (cm)	Shadow gap	Order number	Material	Package/ Large pack
1751	12,5 mm	300	20 mm	106802	Galvanised steel	25 PCS / 105 BUN

Connecting profile for dry lining

Galvanised steel render stop with 15-mm shadow joint. For creating plastered single edges at plastered junctions, e.g. sliding ceiling and wall connections, for 12.5-mm plasterboard panels.

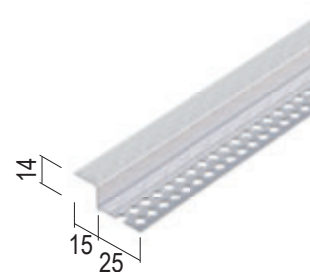

Item number	Plasterboards (mm)	Length (cm)	Shadow gap	Order number	Material	Package/ Large pack
1753	12,5 mm	300	15 mm	108422	Galvanised steel	25 PCS / 120 BUN

Connecting profile for dry lining

Stop profile made of galvanised steel for assemblies underneath plasterboard panels, with a 10-mm shadow joint. For creating plastered single edges at plastered junctions, e.g. sliding ceiling and wall connections, for 15-mm plasterboard panels.

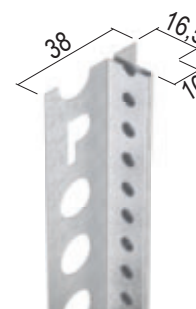

Item number	Plasterboards (mm)	Length (cm)	Shadow gap	Order number	Material	Package/ Large pack
1304	15 mm	300	10 mm	106405	Galvanised steel	15 PCS / 83 BUN

Connecting profile for dry lining

Stop profile made of galvanised steel for assemblies underneath plasterboard panels, with a 20-mm shadow joint. For creating plastered single edges at plastered junctions, e.g. sliding ceiling and wall connections, for 12.5-mm plasterboard panels.

Stainless steel version: 2263

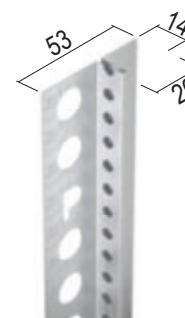

Item number	Plasterboards (mm)	Length (cm)	Shadow gap	Order number	Material	Package/ Large pack
1313	12,5 mm	250	20 mm	101136	Galvanised steel	15 PCS / 69 BUN
	12,5 mm	300	20 mm	101143	Galvanised steel	15 PCS / 69 BUN

Connecting profile for dry lining

Stop profile made of galvanised steel for assemblies underneath plasterboard panels, with a 20-mm shadow joint. For creating plastered single edges at plastered junctions, e.g. sliding ceiling and wall connections, for 15-mm plasterboard panels.

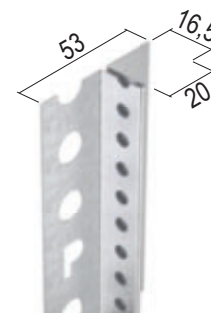

Item number	Plasterboards (mm)	Length (cm)	Shadow gap	Order number	Material	Package/ Large pack
1315	15 mm	300	20 mm	101190	Galvanised steel	15 PCS / 70 BUN

SHADOW JOINT PROFILES

Connecting profile for dry lining

Stop profile made of galvanised steel for assemblies underneath plasterboard panels, with a 15-mm shadow joint. For creating plastered single edges at plastered junctions, e.g. sliding ceiling and wall connections, for 15-mm plasterboard panels.

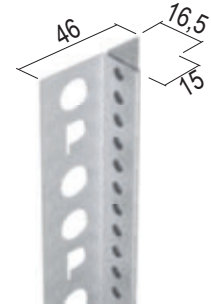

Item number	Plasterboards (mm)	Length (cm)	Shadow gap	Order number	Material	Package/ Large pack
1328	15 mm	300	15 mm	101312	Galvanised steel	15 PCS / 76 BUN

Connecting profile for dry lining

Stop profile made of galvanised steel for assemblies underneath plasterboard panels, with a 6-mm shadow joint. For creating plastered single edges at plastered junctions, e.g. sliding ceiling and wall connections, for 15-mm plasterboard panels.

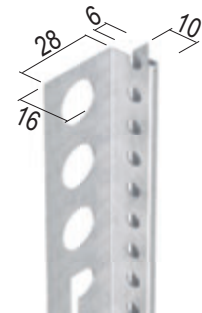

Item number	Plasterboards (mm)	Length (cm)	Shadow gap	Order number	Material	Package/ Large pack
1374	15 mm	300	6 mm	108514	Galvanised steel	10 PCS / 165 BUN

Connecting profile for dry lining

Stop profile made of galvanised steel for assemblies underneath plasterboard panels, with a 5-mm shadow joint. For creating plastered single edges at plastered junctions, e.g. sliding ceiling and wall connections, for 15-mm plasterboard panels.

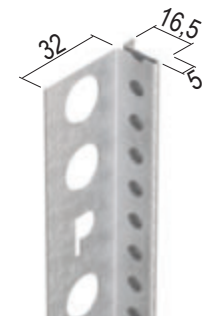

Item number	Plasterboards (mm)	Length (cm)	Shadow gap	Order number	Material	Package/ Large pack
1377	15 mm	300	5 mm	106406	Galvanised steel	15 PCS / 168 BUN

Connecting profile for dry lining

Stop profile made of galvanised steel for assemblies underneath plasterboard panels, with a 6-mm shadow joint. For creating plastered single edges at plastered junctions, e.g. sliding ceiling and wall connections, for 20-mm plasterboard panels.

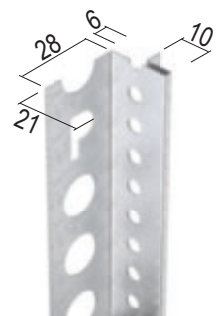

Item number	Plasterboards (mm)	Length (cm)	Shadow gap	Order number	Material	Package/ Large pack
1375	20 mm	300	6 mm	108513	Galvanised steel	10 PCS / 144 BUN

Connecting profile for dry lining

Stop profile made of galvanised steel for assemblies underneath plasterboard panels, with a 20-mm shadow joint. For creating plastered single edges at junctions, e.g. sliding ceiling and wall connections, for 25-mm plasterboard panels.

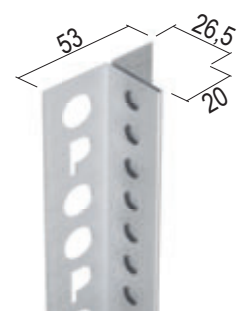

Item number	Plasterboards (mm)	Length (cm)	Shadow gap	Order number	Material	Package/ Large pack
1325	25 mm	300	20 mm	101306	Galvanised steel	15 PCS / 42 BUN

SHADOW JOINT PROFILES

Connecting profile for dry lining

PVC render stop with 6-mm shadow joint. For creating plastered single edges at plastered junctions, e.g. sliding ceiling and wall connections, for 12.5-mm plasterboard panels.

Colour: 10 - white
Notes:
 Trim-Tex AS5410
 1/2" x 1/4" Z Shadow

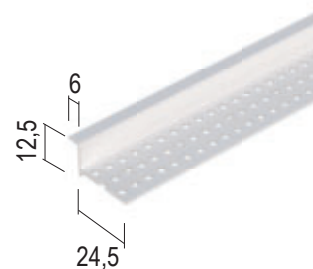

Item number	Plasterboards (mm)	Length (cm)	Shadow gap	Order number	Material	Package/ Large pack
37814	ab 12,5 mm	305	6 mm	114374	Hard PVC	50 PCS / 80 BOX
37824	ab 12,5 mm	305	12 mm	114371	Hard PVC	50 PCS / 80 BOX
37834	ab 12,5 mm	305	18 mm	114370	Hard PVC	50 PCS / 80 BOX

Connecting profile for dry lining

End profile made of PVC with 15 mm shadow gap. For producing finishes filled on one side, e.g. B. in the area of sliding ceiling or wall connections, for plasterboard from 15 mm.

Colour: 10 - white
Notes:
 Trim-Tex AS6010
 5/8" x 5/8" Z Shadow



Item number	Plasterboards (mm)	Length (cm)	Shadow gap	Order number	Material	Package/ Large pack
37827	15 mm	305	15 mm	119532	Hard PVC	50 PCS / 80 BOX

Connecting profile for dry lining

End profile made of PVC with 18 mm shadow gap. For producing finishes filled on one side, e.g. B. in the area of sliding ceiling or wall connections, for plasterboard from 15 mm.

Colour: 10 - white
Notes:
 Trim-Tex AS5910
 5/8" x 3/4" Z Shadow



Item number	Plasterboards (mm)	Length (cm)	Shadow gap	Order number	Material	Package/ Large pack
37825	15 mm	305	18 mm	119533	Hard PVC	50 PCS / 80 BOX

Connecting profile for dry lining

Connection and end profile made of PVC with shadow gap 9 mm for plasterboard from 9.5 mm. Cut on one side for the production of curved connections and terminations, e.g. B. in the area of sliding ceiling or wall connections. Additionally with tear-off protective strip to protect adjacent components from contamination.

Colour: 10 - white
Notes:
 Trim-Tex 5550T
 3/8" X 3/8" Tear Away Shadow Archway



Item number	Plasterboards (mm)	Length (cm)	Shadow gap	Order number	Material	Package/ Large pack
37822	9,5 mm mm	305	9 mm	119530	Hard PVC	25 PCS / 96 BOX

SHADOW JOINT PROFILES

Connecting profile for dry lining

End profile made of PVC with 12 mm shadow gap. For producing finishes filled on one side, e.g. B. in the area of sliding ceiling or wall connections, for plasterboard from 12.5 mm. Additionally with tear-off protective strip to protect adjacent components from contamination.

Notes:
Trim-Tex 5510T
½" X ½" Tear Away Shadow



Item number	Plasterboards (mm)	Length (cm)	Order number	Colour	Material	Package/ Large pack
3789	12,5 mm	305	115251	10 - white	Hard PVC	25 PCS / 96 BOX

Connecting profile for dry lining

PVC render stop for creating single plastered endings with 12-mm shadow joints. For plasterboard panels of 12.5 mm and thicker.

Colour: 10 - white
Notes:
Trim-Tex AS8710
½" x ½" F Reveal

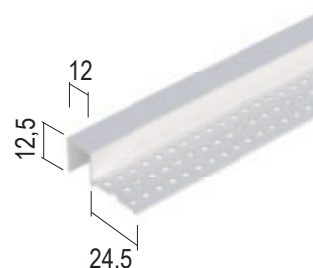

Item number	Plasterboards (mm)	Length (cm)	Shadow gap	Order number	Material	Package/ Large pack
37844	ab 12,5 mm	305	12 mm	114400	Hard PVC	25 PCS / 80 BOX
37842	9,5 mm	305	9 mm	119544	Hard PVC	25 PCS / 80 BOX

Connecting profile for dry lining

PVC stop profile for creating single plastered endings with shadow joints. For plasterboard panels of 12.5 mm and thicker with pull-out cover strips.

Colour: 10 - white
Notes:
Trim-Tex 9140
Caulk Channel Tear Away 10'

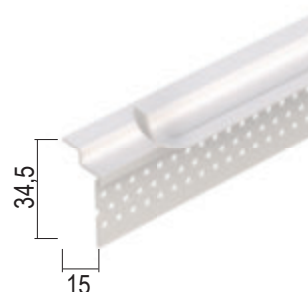

Item number	Plasterboards (mm)	Length (cm)	Shadow gap	Order number	Material	Package/ Large pack
3788	15 mm	305	5 mm	114398	Hard PVC	40 PCS / 80 BOX

CONNECTING PROFILES

Connecting profile for dry lining

Stainless steel shadow joint profile for plasterboard panels of 12.5 mm and thicker.

Gypsum plasterboards: 12,5 mm
Shadow gap: 20 mm

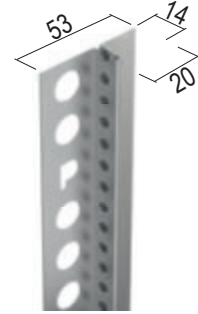

Item number	Plaster thickness (mm)	Length (cm)	Order number	Material	Package/ Large pack
2263	14 mm	250	101386	Stainless steel	15 PCS / 69 BUN

Connecting profile for dry lining

Stainless steel connection profile with filler perforations and 15 mm formed shadow joint for 12.5-mm plasterboard panels.

Gypsum plasterboards: 12,5 mm
Shadow gap: 15 mm

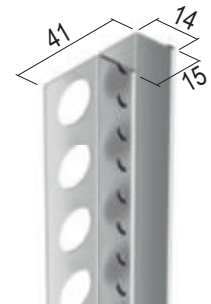

Item number	Plaster thickness (mm)	Length (cm)	Order number	Material	Package/ Large pack
2241	14 mm	250	106468	Stainless steel	15 PCS / 108 BUN

Connecting profile for dry lining

PVC stop profile for creating single plastered endings with shadow joints. For plasterboard panels of 12.5 mm and thicker with pull-out cover strips.

Colour: 10 - white

Notes:

Trim-Tex 3010

½" Pullaway® L Bead

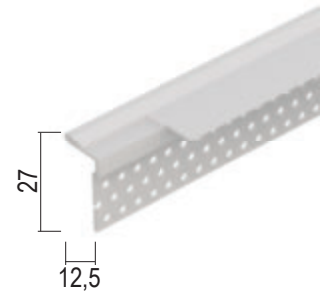

Item number	Plasterboards (mm)	Length (cm)	Order number	Material	Package/ Large pack
3766	ab 12,5 mm	300	102559	Hard PVC	35 PCS / 70 BOX

Connecting profile for dry lining

PVC stop profile for creating one-side trowled graduations. For plasterboard panels of 9.5 mm and thicker. With two flexible lips and detachable protective strips for protecting adjacent building elements.

Colour: 10 - white

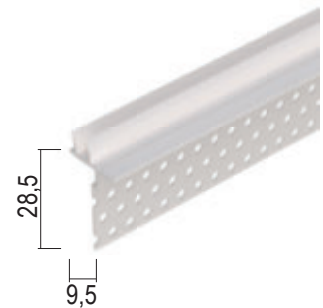

Item number	Plasterboards (mm)	Length (cm)	Order number	Material	Package/ Large pack
3784	ab 9,5 mm	300	102620	Hard PVC	30 PCS / 63 BOX

Connection profile with shadow gap and connection lip DL

Connection and end profile made of PVC Shadow gap from 6.5 to 3.5 mm for plasterboard from 9.5 mm with round connection lip and tear-off Strips to protect adjacent components. For the production of one-sided fillers Connections and terminations.

Notes:

Trim-Tex 9210

⅜" Super Seal Tear Away®



Item number	Plasterboards (mm)	Length (cm)	Order number	Colour	Material	Package/ Large pack
NEW 37832	9,5 mm	305	119557	10 - white	Hard PVC	25 PCS / 96 BOX

CONNECTING PROFILES

Connection profile with narrow sealing lip

Connection and end profile made of PVC for all plasterboard thicknesses with connection lip and tear-off Strips to protect adjacent components. For the production of one-sided fillers Connections and terminations.

Notes:
Trim-Tex 9230
Flat Deflection Bead



Item number	Plasterboards (mm)	Length (cm)	Order number	Colour	Material	Package/ Large pack
NEW 37863		305	119556	10 - white	Hard PVC	60 PCS / 42 BOX

Connection profile with flexible soft connection

Connection and end profile made of PVC for plasterboard from 6.5 mm with connection lip and tear-off Strips to protect adjacent components. For the production of one-sided fillers Connections and terminations.

Notes:
Trim-Tex 9220
Deflection Bead



Item number	Plasterboards (mm)	Length (cm)	Order number	Colour	Material	Package/ Large pack
NEW 37848	6,5 mm	305	119542	10 - white	Hard PVC	48 PCS / 42 BOX

DESIGN PROFILES

Shadow joint profile for dry lining

PVC decorative profile with 13-mm shadow joint. For joining on plasterboard panels of 12.5 mm and thicker on one side. For vertical and horizontal applications.

Colour: 10 - white
Notes:
 Trim-Tex AS5110
 1/2" x 1/2" Reveal

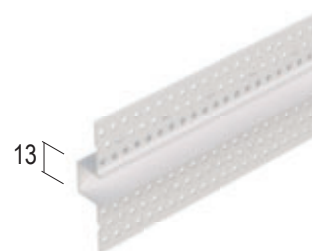

Item number	Plasterboards (mm)	Length (cm)	Order number	Material	Package/ Large pack
37724	ab 12,5 mm	305	114369	Hard PVC	20 PCS / 63 BOX

Shadow joint profile for dry lining

PVC decorative profile with 20-mm shadow joint. For joining on plasterboard panels of 12.5 mm and thicker on one side. For vertical and horizontal applications.

Colour: 10 - white
Notes:
 Trim-Tex AS5210
 1/2" x 3/4" Reveal Bead



Item number	Plasterboards (mm)	Length (cm)	Order number	Material	Package/ Large pack
37734	ab 12,5 mm	305	114373	Hard PVC	15 PCS / 63 BOX

Shadow joint profile for dry lining

PVC render stop with 25-mm shadow joint. For joining on plasterboard panels of 12.5 mm and thicker on one side. For vertical and horizontal applications.

Colour: 10 - white
Notes:
 Trim-Tex AS5310
 1/2" x 1" Reveal

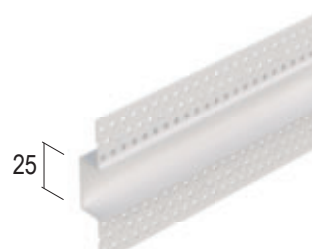

Item number	Plasterboards (mm)	Length (cm)	Order number	Material	Package/ Large pack
37744	ab 12,5 mm	305	114372	Hard PVC	15 PCS / 63 BOX

JOINT PROFILES

Expansion joint profile for dry lining

Expansion joint profiles made of galvanised steel, with an expansion element made of flexible PVC, joins building wall and ceiling expansion joints. For 12.5-mm plasterboard panels. Movement absorption: Pull/push +5/-2 mm.

Movement absorption tension/compression:
+5/-2 mm

Notes:
PVC central piece offers limited possibilities for applying suitable coatings. Approval is required from the coating material manufacturer.



Item number	Plasterboards (mm)	Length (cm)	Order number	Colour	Material	Package/ Large pack
3226	12,5 mm	300	101514	10 - white	Galvanised steel	5 PCS / 70 BUN

Expansion joint profile for dry lining

White PVC movement joint profile with flexible PVC centre for producing movement joints in walls or ceilings according to the requirements of DIN 18181.

Ideally suited for installation on surfaces as well as inside corners. Apply plaster to the entire surface on both sides of the profile up to the flexible PVC centre and secure with clips.

Be aware of noise and fire protection requirements. Movement absorption: Pull/push +1/-1 mm.

Movement absorption tension/compression:
+/-1,5 mm

Notes:
PVC central piece offers limited possibilities for applying suitable coatings. Approval is required from the coating material manufacturer.

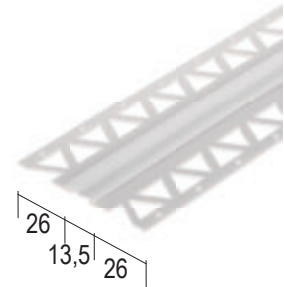

Item number	Plasterboards (mm)	Length (cm)	Order number	Colour	Material	Package/ Large pack
3758	ab 8 mm	2	115058	10 - white	Rigid PVC with soft PVC	1 ROL / 50 BOX

Expansion joint profile for dry lining

White PVC movement joint profile with flexible PVC centre for producing movement joints in walls or ceilings according to the requirements of DIN 18181.

Ideally suited for installation on surfaces as well as inside corners. Apply plaster to the entire surface on both sides of the profile up to the flexible PVC centre and secure with clips.

Be aware of noise and fire protection requirements. Movement absorption: Pull/push +1/-1 mm.

Movement absorption tension/compression:
+/-1,5 mm

Notes:
Trim-Tex SPPR3750
Magic Corner

PVC central piece offers limited possibilities for applying suitable coatings. Approval is required from the coating material manufacturer.

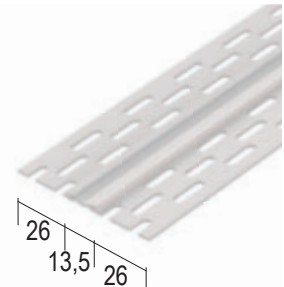

Item number	Plasterboards (mm)	Length (cm)	Order number	Colour	Material	Package/ Large pack
3750	ab 8 mm	7	102521	10 - white	Rigid PVC with soft PVC	1 ROL / 120 BOX
37509	ab 8 mm	2	114624	10 - white	Rigid PVC with soft PVC	1 ROL / 144 BOX
37507	ab 8 mm	305	118343	10 - white	Rigid PVC with soft PVC	50 PCS / 80 BOX

JOINT PROFILES

Expansion joint profile for dry lining

White PVC movement joint profile with a flexible PVC centre, including two stop ridges, specially designed to facilitate easy installation on flat surfaces. Fitted with two detachable safety strips to protect the centre part. For producing movement joints in walls or ceilings according to the requirements of DIN 18181. Apply plaster to the entire surface on both sides of the profile up to the flexible PVC centre and apply clips. Be aware of noise and fire protection requirements. Movement absorption: Pull/push +/-2 mm.

Movement absorption tension/compression:
+/-2 mm

Notes:
Trim-Tex 2710
Hideaway Expansion

PVC central piece offers limited possibilities for applying suitable coatings. Approval is required from the coating material manufacturer.

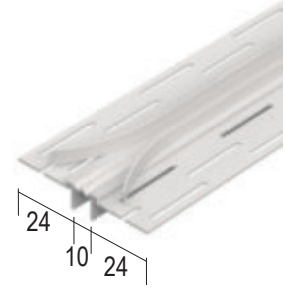

Item number	Plasterboards (mm)	Length (cm)	Order number	Colour	Material	Package/ Large pack
3755	ab 9,5 mm	305	109062	10 - white	Rigid PVC with soft PVC	25 PCS / 63 BOX

Expansion joint profile for dry lining

Movement joint profile made of PVC with a flexible connection in the middle part, which enables a controlled movement of 9.5 mm. The tear-off strip protects the middle from the filler and also serves as a guide. A proper base on fire-proof walls remains necessary.

Gypsum plasterboards: 9,5 mm

Notes:
Trim-Tex 093V
093V Expansion



Item number	Plaster thickness (mm)	Length (cm)	Order number	Material	Package/ Large pack
8068	1 mm	305	110405	Hard PVC	20 PCS / 80 BUN

EDGING PROFILES

Edge profile for dry lining

Edging profile for drywall made of galvanized steel, for plasterboard of 12.5 mm.



Item number	Plasterboards (mm)	Length (cm)	Order number	Material	Package/ Large pack
1233		300	109156	Galvanised steel	50 PCS / 47 BOX

Edge profile for dry lining

Clip-on profile made of galvanised steel sheets for various plasterboard thicknesses, connections and edges. **Colour: 10 - white**

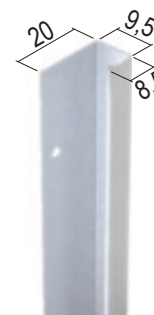

Item number	Plasterboards (mm)	Length (cm)	Order number	Material	Package/ Large pack
1120	9,5 mm	250	107948	Galvanised steel, with white basic coating	25 PCS / 99 BUN
1121	12,5 mm	250	106574	Galvanised steel, with white basic coating	25 PCS / 90 BUN
	12,5 mm	300	106575	Galvanised steel, with white basic coating	25 PCS / 70 BUN
1122	15 mm	250	107657	Galvanised steel, with white basic coating	25 PCS / 70 BUN
1123	18 mm	250	101022	Galvanised steel, with white basic coating	25 PCS / 63 BUN

Edge profile for dry lining

PVC edging profile for a plasterboard thickness of 9.5 mm. For creating precise connections and edges. **Colour: 10 - white**

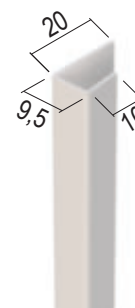

Item number	Plasterboards (mm)	Length (cm)	Order number	Material	Package/ Large pack
3738	9,5 mm	250	114632	Hard PVC	50 PCS / 36 BOX
3741	12,5 mm	250	114626	Hard PVC	50 PCS / 36 BOX
	12,5 mm	300	114627	Hard PVC	50 PCS / 36 BOX
3747	15 mm	250	114745	Hard PVC	50 PCS / 36 BOX
	15 mm	300	114747	Hard PVC	50 PCS / 36 BOX

Self adhesive edge profile for dry lining

Self-adhesive edging profile made of white PVC with protective lip, for 12.5 mm gypsum panels, e.g. for creating gypsum panel connections to windows and doors. Verified and tested airtightness. **Colour: 10 - white**

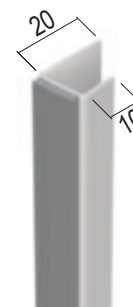

Item number	Plasterboards (mm)	Length (cm)	Order number	Material	Package/ Large pack
3735	12,5 mm	250	102240	Hard PVC	50 PCS / 36 BOX
	12,5 mm	300	118460	Hard PVC	50 PCS / 36 BOX

EDGING PROFILES

Selfadhesive edge profile for dry lining

Self-adhesive edging profile made of white PVC with protective lip, for 12.5 mm gypsum panels, e.g. for creating gypsum panel connections to windows and doors. Verified and tested airtightness.

Colour: BF - traffic white

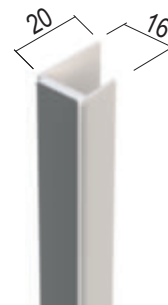

Item number	Plasterboards (mm)	Length (cm)	Order number	Material	Package/ Large pack
37361	12,5 mm	250	111699	Rigid PVC with soft PVC	50 PCS / 36 BOX
	12,5 mm	270	111953	Rigid PVC with soft PVC	50 PCS / 36 BOX
	12,5 mm	300	111954	Rigid PVC with soft PVC	50 PCS / 36 BOX

Selfadhesive fillable edging profile for dry lining

Self-adhesive edging profile made of white PVC with protective lip, for 12.5 mm gypsum panels with overfillable leg, protective lip and tear-off adhesive flap for foil cover, e.g. for creating gypsum panel connections to windows and doors. Verified and tested airtightness.

Colour: 10 - white

Processing instructions: The movement absorption is limited to the movement absorption of the foam tape by filling the leg that can be filled over.



Item number	Plasterboards (mm)	Length (cm)	Order number	Material	Package/ Large pack
NEW	12.5 mm	250	118905	Rigid PVC with soft PVC	25 PCS / 24 BOX
NEW	12.5 mm	270	118906	Rigid PVC with soft PVC	25 PCS / 24 BOX
NEW	12.5 mm	300	118908	Rigid PVC with soft PVC	25 PCS / 24 BOX

Edge profile for dry lining

"Göppinger" profile and PVC edging profile in one!

Colour: 10 - white

Notes:
Trim-Tex 1710
½" Mud On J Bead

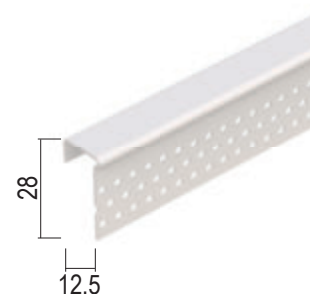

Item number	Plasterboards (mm)	Length (cm)	Order number	Material	Package/ Large pack
3787	12,5 mm	305	102295	Hard PVC	50 PCS / 80 BOX

Corner edge profile for dry lining

PVC corner edging profile for a plasterboard thickness of 12.5 mm.

Colour: 10 - white

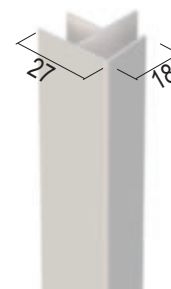

Item number	Plasterboards (mm)	Length (cm)	Order number	Material	Package/ Large pack
3744	12,5 mm	250	101729	Hard PVC	50 PCS / 16 BUN
	12,5 mm	300	101733	Hard PVC	50 PCS / 16 BUN

Picture profile for dry lining

Picture rail made of galvanised metal sheets for 12.5-mm plasterboard panels.

White aluminium version: 91118

Notes:

Only for purely static load of max. 0,15 kN/m.
Not suitable for multimedia devices.

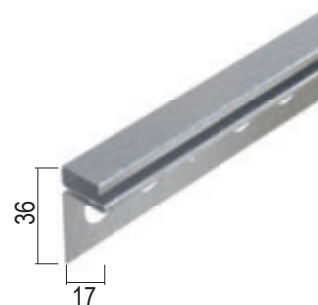

Item number	Plasterboards (mm)	Length (cm)	Order number	Material	Package/ Large pack
1118	12,5 mm	250	101006	Galvanised steel	15 PCS / 95 BUN
91118	12,5 mm	250	112403	Aluminum, with basic coating	15 PCS / 95 BUN

Hook for Picture profile 1118/91118

High-quality aluminium picture hooks for picture rails 1118/91118.



Item number	Plasterboards (mm)	Length (cm)	Order number	Material	Package/ Large pack
92125		3	112275	Aluminum natural	20 PC / 99 BEU

Picture profile for dry lining

Aluminium picture rail for 12.5 mm plasterboards for wall-side installations.
Only for purely static loads. Max. load: 0.15 kN/lfm. Not suitable for multimedia devices.

Notes:

Only for purely static load of max. 0,15 kN/m.
Not suitable for multimedia devices.

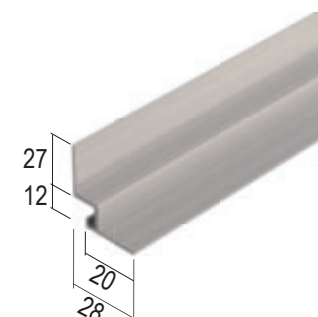

Item number	Plasterboards (mm)	Length (cm)	Order number	Material	Package/ Large pack
92118		300	107242	Aluminum natural	5 PCS / 264 BUN

Hook for Picture profile 92118

High-quality aluminium picture hooks for picture rail 92118.



Item number	Plasterboards (mm)	Length (cm)	Order number	Material	Package/ Large pack
92126		3	112276	Aluminum natural	20 PC / 99 BEU

IMAGES BAR

Zipper for Nylonrope

Zipper for perlon cord.

Notes:

Complement to perlon rope with loop 92123 and 92124.



Item number	Plaster thickness (mm)	Length (cm)	Order number	Material	Package/ Large pack
92122		2	107246	Galvanised steel	20 PC / 99 BOX

Nylonrope with loop

Perlon rope with loop

Notes:

Addition to Zipper 92122.



Item number	Plaster thickness (mm)	Length (cm)	Order number	Material	Package/ Large pack
92123		100	107247	Nylon	20 PC / 99 BOX
92124		200	107248	Nylon	20 PC / 99 BOX

COMPOSITE PROFILES

Composite corner bead "WET-FLEX 100" for dry lining

Flexible, self-sticking composite profile from the roll with a water-activatable adhesive side. It's suitable for inside and outside edges in every angle positions.

Material thickness (mm): 0,8 mm

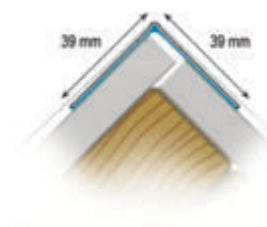

Item number	Plaster thickness (mm)	Length (cm)	Order number	Material	Package/ Large pack
37320	1 mm	3	114761		8 ROL / 24 BOX

Composite corner bead "OS-300" for dry lining

Paper-concealed composite profile for the production of precise edges in the drywall construction. The adjusted angle allows an expeditious treatment on 90° outside edges.

Material thickness (mm): 0,8 mm

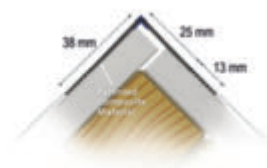

Item number	Plaster thickness (mm)	Length (cm)	Order number	Material	Package/ Large pack
37324	1 mm	274	114451		50 PCS / 99 BOX

Composite corner bead "IS-300" for dry lining

Paper-concealed composite profile for the production of precise outside edges in the drywall construction. The adjusted angle allows an expeditious treatment on 90° outside edges.

Material thickness (mm): 0,8 mm

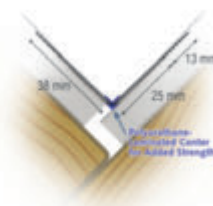

Item number	Plaster thickness (mm)	Length (cm)	Order number	Material	Package/ Large pack
37323	1 mm	274	114450		50 PCS / 99 BOX

Composite corner bead "BIG-STICK 300" for dry lining

Composite profile for the production of precise edges in drywall construction. The adjusted angle allows an expeditious treatment on 90° outside edges. Because of the reinforced composite head, it's able to produce a particularly stable edge.

Material thickness (mm): 0,8 mm

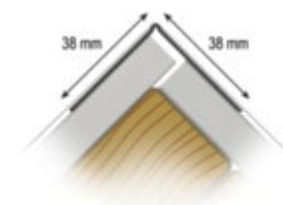

Item number	Plaster thickness (mm)	Length (cm)	Order number	Material	Package/ Large pack
37325	1 mm	274	114452		50 PCS / 99 BOX

Composite corner bead "MID-FLEX" for dry lining

Flexible, paper-concealed composite profile of the role, it's suitable for inside and outside edges in every angle position.

Material thickness (mm): 0,8 mm

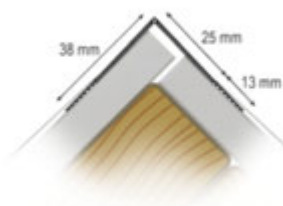

Item number	Plaster thickness (mm)	Length (cm)	Order number	Material	Package/ Large pack
37322	1 mm	3,050	114762		10 ROL / 24 BOX

COMPOSITE PROFILES

Composite corner bead "GOLD" for dry lining

Flexible, paper-concealed composite profile of the role, it's suitable for inside and outside edges in every angle position.

Material thickness (mm): 0,8 mm

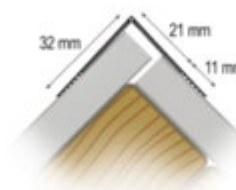

Item number	Plaster thickness (mm)	Length (cm)	Order number	Material	Package/ Large pack
37340	1 mm	3	117043		10 ROL / 24 BOX

Composite corner bead "UNO-BEAD 222" for dry lining

Flexible, paper-flocked composite profile of the role, it's suitable for inside and outside edges in every angle position.

Material thickness (mm): 0,9 mm

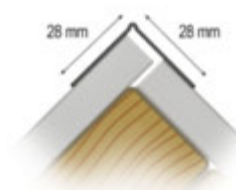

Item number	Plaster thickness (mm)	Length (cm)	Order number	Material	Package/ Large pack
37331	1 mm	3	114991		12 ROL / 28 BOX

Composite corner bead "ORIGINAL" for dry lining

Flexible, paper-flocked composite profile of the role, it's suitable for inside and outside edges in every angle position.

Material thickness (mm): 0,8 mm

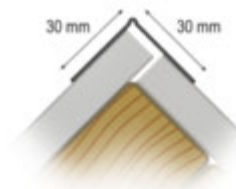

Item number	Plaster thickness (mm)	Length (cm)	Order number	Material	Package/ Large pack
37329	1 mm	3	114990		12 ROL / 24 BOX

Composite "Fast Edge" corner bead for dry lining

Paper-concealed composite profile for the production of precise edges in the drywall construction. The adjusted angle allows an expeditious treatment on 90° outside edges.

Notes:

Trim-Tex FEP09
Large Fast Edge® Paper 9'

Processing instructions: Inserting full-surface in the filling compound like conventional profiles with the printed side facing out. Putting the embossed paper wing, the remaining profile leg doesn't need to be filled full-surface over.

Please notice the treatment note in the technical datasheets!

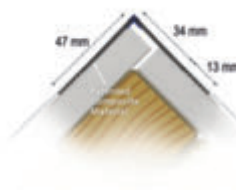

Item number	Plaster thickness (mm)	Length (cm)	Order number	Material	Package/ Large pack
37317	1 mm	274	118688		50 PCS / 54 BOX

COMPOSITE PROFILES

Composite corner bead "Fast Edge Roll" for dry lining

Flexible, paper-concealed composite profile of the role, it's suitable for inside and outside edges in every angle position. The profile will get the desired angular position by creasing. The roll material allows an individual adjustment of the profile to the edge and thus reduces waste and costs.

Material thickness (mm): 0,8 mm

Notes:

Trim-Tex FE275R

Fast Edge® Roll 2.75"

Processing instructions: Inserting full-surface in the filling compound like conventional profiles with the printed side facing out. Filling the embossed paper wing in, the remaining profile leg doesn't need to be filled full-surface over.

Please notice the treatment note in the technical datasheets!

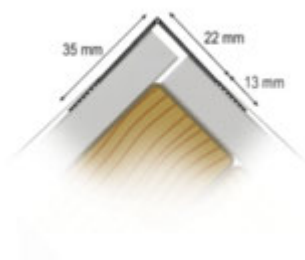

Item number	Plaster thickness (mm)	Length (cm)	Order number	Material	Package/ Large pack
37318	1 mm	3	118689		10 ROL / 12 BOX

Composite corner bead "ARCH-FLEX 100" for arches in dry lin.

Flexible composite profile with incised legs for the production of precise edges in curved or arched constructions, suitable for inside and outside edges in every angle adjustments.

Material thickness (mm): 0,8 mm

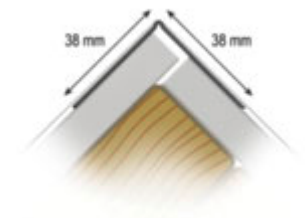

Item number	Plaster thickness (mm)	Length (cm)	Order number	Material	Package/ Large pack
37327	1 mm	3,050	114764		12 ROL / 20 BOX

Composite corner bead "PERFECT-90°" for dry lining

Flexible, paper-concealed composite profile of the role, it's suitable for perfect 90° inside edges.

Material thickness (mm): 0,6 mm

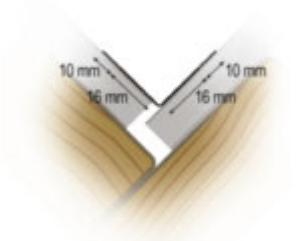

Item number	Plaster thickness (mm)	Length (cm)	Order number	Material	Package/ Large pack
37333	1 mm	3	114993		12 ROL / 30 BOX

Composite strip "TUFF-TAPE" for inside edges and joints

Flexible, paper-flocked composite profile of the role, it's suitable for inside edges in every angle position and panel joints.

Material thickness (mm): 0,8 mm

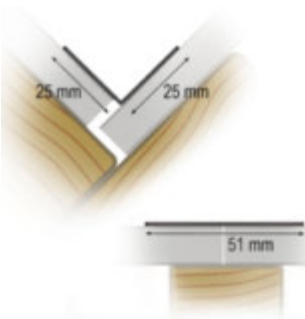

Item number	Plaster thickness (mm)	Length (cm)	Order number	Material	Package/ Large pack
37339	1 mm	3,050	115031		12 ROL / 24 BOX

COMPOSITE PROFILES

Composite stop an connecting bead "L-BEAD 300" for dry lin.

Flexible composite profile for the production of precise connections and terminations in drywall construction. The profile of the role will get the desired angular position by creasing.

Material thickness (mm): 0,8 mm

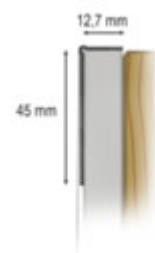

Item number	Plaster thickness (mm)	Length (cm)	Order number	Material	Package/ Large pack
37326	1 mm	3	114763		12 ROL / 24 BOX

Composite stop and connecting bead "EDGE-TAPE"

Flexible, paper-concealed composite profile for making perfect connections to windows or other wall connections in drywall construction.

Material thickness (mm): 0,8 mm

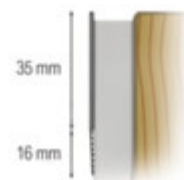

Item number	Plaster thickness (mm)	Length (cm)	Order number	Material	Package/ Large pack
37334	1 mm	3	114994	paper	12 ROL / 20 BOX

ROLL-PATCH 5.5" for drywall repairs; Repairpatch, rol

Flexible composite strip from the roll for flat filling.

Material thickness (mm): 0,6 mm
Product width: 140 mm



Item number	Plaster thickness (mm)	Length (cm)	Order number	Material	Package/ Large pack
37328	1 mm	610	114765		6 ROL / 24 BOX

Composite corner bead "WET-STICK 90" for dry lining

Self-sticking composite profile with a water-activatable adhesive side for the production of precise edges in the drywall construction. The adjusted angle allows an expeditious treatment on 90° outside edges.

Material thickness (mm): 0,8 mm

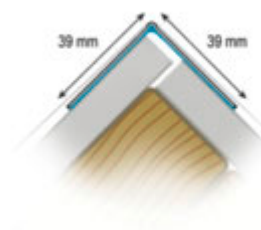

Item number	Plaster thickness (mm)	Length (cm)	Order number	Material	Package/ Large pack
37321	1 mm	274	114448		50 PCS / 64 BOX

JOINT COVER STRIPS

Joint cover strips

Glass fibre mesh for thermal insulation.
4 x 5 mm, 160 g/m² yellow, width 1,1 m

Mesh size: 2 x 2 mm
Grammage: 55 g/m²

Item number	Width (mm)	Length (cm)	Order number	Material	Color	Package/ Large pack
14950	50	15	119709	Glass fiber	10 - white	12 PC / 18 BOX
14951	50	9	119710	Glass fiber	10 - white	24 PC / 25 BOX
14952	50	4	119711	Glass fiber	10 - white	54 PC / 18 BOX
14953	50	2	119712	Glass fiber	10 - white	60 PC / 18 BOX
14954	50	2	119713	Glass fiber	10 - white	60 PC / 18 BOX
14955	100	9	119714	Glass fiber	10 - white	12 PC / 25 BOX
14956	100	4	119715	Glass fiber	10 - white	27 PC / 18 BOX



Spatula fabric self-adhesive

Mesh size: 2 x 2 mm
Grammage: 55 g/m²

Item number	Fabric dimension	Order number	Material	Color	Package/ Large pack
14957	100 cm x 100 m	119853	Glass fiber	10 - white	100 M2 / 48 ROL



PROFILE ADHESIVE

Spray adhesive GLUKON prime

Adhesive and contact adhesive for the assembly of filler profiles made of composite material, rigid PVC or metal on various substrates such as plasterboard.

Also suitable for bonding PE foils, vapor barriers, insulation materials such as XPS/EPS, PUR/PIR, etc.



Item number	Description	Order number	Contents	Package/ Large pack
1430	Spray adhesive GLUKON prime	118502	Spray can 500 ml	12 PC / 114 BOX

Spray can handle

Handle for ergonomic processing with the spray can. Good tactile pressure point due to built-in spring mechanism. Prevents hand fatigue. Suitable for most commercially available spray cans.

Notes:
Material: impact resistant plastic



Item number	Description	Order number	Contents	Package/ Large pack
1423	Spray can handle	118515		6 PC / 99 BOX
	Spray can handle	119046		144 PC / 99 BOX

Spray adhesive GLUKON prime

Adhesive and contact adhesive for mounting of filler profiles made of composite, rigid PVC or metal on various substrates such as e.g. plasterboard. Also suitable for bonding of PE foils, vapor barriers, insulating materials such as XPS/EPS, PUR/PIR, etc.

Notes:
Only for Premium Pistole Art. 1428, Schlauch Art. 1427 bzw. Art. 1426.



Item number	Description	Order number	Contents	Package/ Large pack
1429	Spray adhesive GLUKON prime	118503	Pressure vessel 13 kg	1 PC / 12 BOX

Premium Pistol

Premium spray gun as system component for the pressure tank (Art. 1429), incl. nozzle. Particularly robust due to full metal construction, easy spray jet adjustment for maximum precision and of precision and reliability in daily use.



Item number	Description	Order number	Contents	Package/ Large pack
1428	Premium Pistol	118513		1 PC / 99 BOX

Hose for pressure tank

Reinforced high-pressure hoses for a secure and durable connection of the premium gun to the pressure vessel. The length of the hose increases the radius of action and enables thus efficient working.

Notes:
Length: 3,7 m



Item number	Description	Order number	Contents	Package/ Large pack
1426	Hose for pressure tank	118512	3,70 m	1 PC / 99 BOX

PROFILE ADHESIVE

Hose for pressure tank

Reinforced high pressure hose for a safe and long-lasting connection of the premium gun to the pressure vessel. The length of the hose increases the operating radius and thus enables efficient operation.

Notes:
Length: 5,5 m



Item number	Description	Order number	Contents	Package/ Large pack
1427	Hose for pressure tank	118511	5,50 m	1 PC / 99 BOX

Lance 50 cm

Lance made of solid metal for the extension of the premium gun by 50 cm. For ergonomic, back-friendly work on floors working on floors, walls and ceilings. Quick and stepless adjustment of the spray jet width.

Notes:
Length: 50 cm



Item number	Description	Order number	Contents	Package/ Large pack
1425	Lance 50 cm	118514		1 PC / 99 BOX

Transport trolley

Stable transport cart with rollers with stable holding basket for the pressure vessel.

Notes:
With smooth-running swivel castors (2 with parking brake).
Guide handle infinitely height adjustable.



Item number	Description	Order number	Contents	Package/ Large pack
1424	Transport trolley	118517		1 PC / 1 BOX

Citrus Cleaner

Citrus cleaning spray, highly effective cleaning agent on a natural basis. PH neutral, non-corrosive mode of action. Particularly suitable for cleaning closed-pore and colorfast surfaces.

Notes:
Do not use as a remover!
Carry out a preliminary test at a concealed location



NEW

Item number	Description	Order number	Contents	Package/ Large pack
1422	Citrus Cleaner	118516	500 ml	12 PC / 99 BOX

INTERNAL CONSTRUCTION

Compound applicator "MUD-PRO MP2-MOUNTED"

Material applicator "Mud-Pro MP 2" for an efficient and cost-saving processing of composite profiles for inside and outside edges. Allows an even application of material directly to the profile and can be used for paper-laminated composite profiles and composite profiles, which are applied with putty. The application device consists of a solid and durable stainless steel construction. No daily cleaning required, after completion of work, the wings are folded and the application device soaked in sufficient water.

The material applicator Mud-Pro MP2 includes the upper and lower bucket as well as the applicator.



Item number	Plaster thickness (mm)	Length (cm)	Order number	Material	Package/ Large pack
1472		34	114441		1 PC / 24 BOX

Outside rolling tool 90° "OUTSIDE ROLLING-TOOL OSR 300"

Outer edge roller "Outside Rolling Tool OSR 300", for pressing paper-laminated composite profiles at 90° outer edges. The outer edge roller in conjunction with the extension pole "Extension Pole EP" 1478 allows ergonomic and efficient processing and guarantees the required uniform contact pressure.

Suitable for product: 37324; 37322; 1478



Item number	Plaster thickness (mm)	Length (cm)	Order number	Material	Package/ Large pack
1473		8	114442		1 PC / 999 BOX

Outside rolling tool 90° "OUTSIDE ROLLING-TOOL WSR"

External edge roller "Outside Rolling Tool WSR" is used for pressing composite profiles at 90° outer edges and is particularly suitable for the wet profiles "Wet-Flex 100" 37320 and "Wet-Stick 90" 37321. The outer edge scooter in conjunction with the extension rod "Extension Pole EP" 1478 enables ergonomic and efficient processing and guarantees the required uniform contact pressure.

Suitable for product: 37327; 37325; 37321; 37320; 1478



Item number	Plaster thickness (mm)	Length (cm)	Order number	Material	Package/ Large pack
1474		8	114443		1 PC / 999 BOX

Inside rolling tool 90° "INSIDE ROLLING-TOOL ISR"

Inside edge roller "Inside Rolling Tool ISR", for pressing paper-laminated composite profiles and composite profiles at 90° inside edges. The inner edge scooter in conjunction with the extension pole "Extension Pole EP" 1478 enables ergonomic and efficient processing and guarantees the required uniform contact pressure.

Suitable for product: 37327; 37323; 37322; 1478



Item number	Plaster thickness (mm)	Length (cm)	Order number	Material	Package/ Large pack
1477		8	114444		1 PC / 999 BOX

TOOLS

Extension pole "EXTENSION POLE EP"

The extension pole supplemented the inner and outer edge. The pole is 91 to 152 cm long and extendable by steps of 15 cm. The comfort handel enabled a excellent handling.

Suitable for product: 1477; 1474; 1473



Item number	Plaster thickness (mm)	Length (cm)	Order number	Material	Package/ Large pack
1478		8	114445		6 PC / 999 BOX

Folding tool "FLEX-FOLDER"

The "Flex-Folder" folding tool is used to adjust the angle of paper-laminated composite profiles and composite profiles from the roll. For efficient and quick preparation of the flexible composite profiles.

Suitable for product: 37327; 37326; 37322; 37320



Item number	Plaster thickness (mm)	Length (cm)	Order number	Material	Package/ Large pack
1479		8	114446		12 PC / 999 BOX

MUD-PRO MP2 spare parts kit

Spare parts set for the Mud-Pro MP 2 material applicator. Contains a shaped piece for the profile insert and a shaped piece with teeth for the material outlet. The material outlet determines the amount of filler that is applied to the composite profile and thus ensures efficient and cost-saving processing of composite profiles for inner and outer edges.



Item number	Plaster thickness (mm)	Length (cm)	Order number	Material	Package/ Large pack
1468		8	115673		1 PC / 20 BOX

Edge Roller Set ISR-OSR-SSR

Edge Roller Set consisting:

- "Outside Rolling Tool OSR"
- "Inside Rolling-Tool ISR"
- "Single Side Rolling-Tool SSR"

for pressing paper-laminated composite profiles at inside- and outside edges.

The rollingtools in conjunction with the extension pole 1478 allows ergonomic and efficient processing and guarantees the required uniform contact pressure.



Item number	Plaster thickness (mm)	Length (cm)	Order number	Material	Package/ Large pack
1469		37	115573		4 PC / 25 BOX

TOOLS

Profile shear

Special cutter with a premarked template for ensuring precise cutting of PVC profiles at a right angle.



Item number	Plaster thickness (mm)	Length (cm)	Order number	Material	Package/ Large pack
1452		26	102376		50 PC / 16 BOX

Special shear for PVC

Special cutter for PVC profiles.



Item number	Plaster thickness (mm)	Length (cm)	Order number	Material	Package/ Large pack
1453		24	111950		1 PC / 999 BOX

Sales racks Protektor

Protektor Verkaufsdisplay für Stab- und Rollenware.

Material: Aluminum



Item number	Plaster thickness (mm)	Length (cm)	Order number	Material	Package/ Large pack
1500		120	117080	Aluminum	1 PC / 1 BOX



PRIMERS THAT ENSURE CLEAN RESULTS



Whether working with plasterboard, concrete or masonry, the construction chemistry product range from Protektor provides the perfect basis for achieving optimal results. Creating the proper substrate conditions is essential for any professional painting, plastering or wallpapering job. Protektor construction chemistry offers a product range that provides perfect priming tailored to the varied requirements of differing substrates. Our various primers ensure that you have a surface for all smooth, highly absorbent, poorly adhering or bleeding substrates. Water-based, solvent-free and eco-friendly bonding primers – for a professional result.

- ▶ **Betonkontakt (Concrete contact)** – Bonding coat on smooth. Concrete Bonding coat for gypsum plaster, gypsum-based render systems and lime plaster.
- ▶ **Aufbrennsperre (Absorbent substrate primer)** – Reduces suction. Primer for substrates with high or varying absorbency.
- ▶ **Putzgrund (Plaster primer)** – white-pigmented bonding primer. Containing quartz e.g. before the application of decorative plasters.
- ▶ **Tiefengrund (Deep primer)** – solvent-free, unpigmented, deep penetrating primer. Primer for stabilising chalky and sandy substrates.
- ▶ **Sperrgrund (Barrier primer)** – isolating and sealing primer For sealing bleed-through substances e.g. for decorative plasters and renders.



PERFEKT VORBEREITET
PROTEKTOR BAUCHEMIE

Die Gipsarten, Beton oder Mauerwerk, mit Bauchemie von Protektor haben Sie die Grundlage für ein geländereifes Ergebnis. Die Schaffung der richtigen Untergrundvoraussetzung ist wesentlich für professionelles Maler-, Putz- und Tapezierarbeiten. Bauchemie Bauchemie bietet Ihnen die Fundamentierung für eine perfekte Ausführung abhängig von der jeweiligen Anforderung der jeweiligen Baustelle. Mit unserer unterschiedlichen Bauchemie haben Sie jetzt die vollständige Lösung für alle glatten, stark saugenden, zu weitgehend oder durchlässigen Untergründe: Betonmörtel, Gipsputz, Putz, Mauerwerk, etc.

- ✓ **Betonkontakt** – Haftbrücke auf glatten Beton
- ✓ **Aufbrennsperre** – Reduzierung des Saugvermögens
- ✓ **Putzgrund** – Quarzteilchen, weiß pigmentierte Bauchemie
- ✓ **Tiefengrund** – Lösungsmittelfrei, ungepigmentierte Tiefengrundlösung
- ✓ **Sperrgrund** – Isolat- und Abkantungsmittel

© Protektor GmbH, 2023. Alle Rechte vorbehalten. www.protektor.com



Concrete Contact primer

Bonding bridge on an even floor. Bonding bridge for system plaster and adhesive binder on smooth concrete.

- alkali resistant
- red pigmentation
- for interiors
- ready to use or as a concentrate.



Item number	Description	Order number	Usage	Contents	Pallet contents
1440	Concrete Contact primer	115141	Approx. 200 - 300 g/m ² depending on substrate.	20 kg	32 BUC
1441	Concrete Contact primer	114571	Approx. 200 - 300 g/m ² depending on substrate.	6 kg	70 BUC

Primer absorb. substr.

Reduces absorbency. Apply primer to substrates with high or varying absorbency.

- high alkali-resistance
- yellow pigmentation
- for interiors and exteriors
- ready to use.



Item number	Description	Order number	Usage	Contents	Pallet contents
1442	Primer absorb. substr.	115142	Approx. 100–200 ml/m ² depending on substrate.	15 L	32 BUC
1482	Primer absorb. substrate Concentrate	115143	Approx. 50–100 ml/m ² (concentrate) depending on the substrate.	15 L	32 BUC

Barrier primer

Isolation and sealing primer. Primer for critical mineral, substrates that show through, e.g. for decorative plaster.

- specially made to prevent against bleeding materials
- improves mechanical bond
- white pigmentation
- for interiors and exteriors
- ready to use.



Item number	Description	Order number	Usage	Contents	Pallet contents
1448	Barrier primer	115140	Approx. 200–300 g/m ² depending on substrate.	15 kg	32 BUC
1449	Barrier primer	114579	Approx. 200–300 g/m ² depending on substrate.	6 kg	70 BUC

Plaster base

Acrylic pigmented undercoat Bonding agent, e.g. prior to applying decorative plasters.

- evens the absorbency of the substrate
- breathable
- weatherproof
- for interior and exteriors
- ready to use and as a concentrate



Item number	Description	Order number	Usage	Contents	Pallet contents
1444	Plaster base	115144	Approx. 200–300 g/m ² depending on substrate.	20 kg	32 BUC
1445	Plaster base	114575	Approx. 200–300 g/m ² depending on substrate.	6 kg	70 BUC

Penetrating primer LF

Solution-free primer. Non-pigmented primer for strengthening chalky and sandy substrates.

- for mineral substrates
- reduces and evens out absorbency
- for interiors and exteriors
- ready to use.

Item number	Description	Order number	Usage	Contents	Pallet contents
1446	Penetrating primer LF	115443	Approx. 100–250 ml/m ² depending on substrate.	10 L	50 KAN
1447	Penetrating primer LF	115444	Approx. 100–250 ml/m ² depending on substrate.	5 L	96 KAN





THE RIGHT CEILING FOR EVERY ROOM

Ready-made solutions of superb quality: flexibility and a wide range of installation options make this an outstandingly reliable system which is quick to install.

The right metal substructure provides the outline for your dream solution. This gives sustainable stability. Our substructures for suspended ceilings are chosen by many architects because of the large degree of freedom they offer in creating plans and in the choice of materials.

STANDARD CEILINGS AND WALLS

PRODUCT CLASS 6000

C-ceiling profile with square return

Application area: hanging ceilings and wall facings.

Material: Galvanised steel
Material thickness (mm): 0,6 mm
Norm: EN 14195:2005
Norm: DIN18182-1
Notes:
 Fixlänge auf Anfrage

Item number	Description	Length (cm)	Order number	Width (mm)	Weight (kg/m/pc)	Package/ Large pack
5118	C 60-27	118	100117	60	0,570	16 PCS / 16 BUN

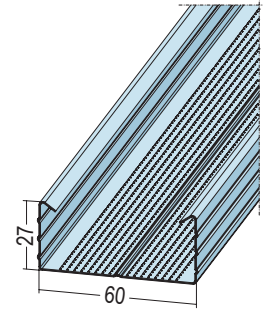

C-ceiling profile with square return

Application area: suspended ceilings and wall facings.

Material: Galvanised steel
Material thickness (mm): 0,6 mm
Norm: EN 14195:2005
Norm: DIN18182-1
Notes:
 Special lengths on request

Item number	Description	Length (cm)	Order number	Width (mm)	Weight (kg/m/pc)	Package/ Large pack
5120	C 60-27	260	110004	60	0,570	12 PCS / 15 BUN
	C 60-27	310	110007	60	0,570	12 PCS / 15 BUN
	C 60-27	400	110008	60	0,570	12 PCS / 15 BUN

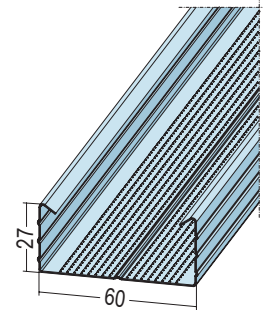

C-ceiling profile with square return 0,7 mm

Application area: hanging ceilings and wall facings.

Material: Galvanised steel
Material thickness (mm): 0,7 mm
Norm: EN 14195:2005
Norm: DIN18182-1
Notes:
 Warning: material thickness of 0.7 mm!!!

Item number	Description	Length (cm)	Order number	Width (mm)	Weight (kg/m/pc)	Package/ Large pack
5116	C 60-27-07	400	109998	60	0,660	12 PCS / 15 BUN

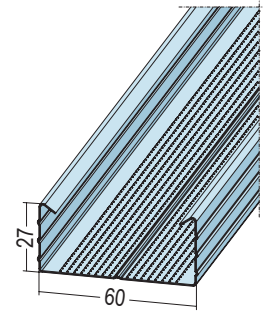

C-ceiling profile with round return

Application area: hanging ceilings and wall facings.

Material: Galvanised steel
Material thickness (mm): 0,6 mm
Norm: EN 14195:2005
Norm: DIN18182-1
Notes:
 Special lengths on request

Item number	Description	Length (cm)	Order number	Width (mm)	Weight (kg/m/pc)	Package/ Large pack
5117	C 60-27	260	109999	60	0,570	12 PCS / 15 BUN
	C 60-27	310	110002	60	0,570	12 PCS / 15 BUN
	C 60-27	400	110003	60	0,570	12 PCS / 15 BUN

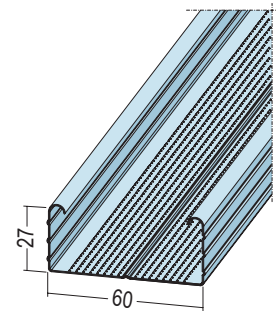

STANDARD CEILINGS AND WALLS

PRODUCT CLASS 6000

C-ceiling profile smooth with square return

Application area: hanging ceilings and wall facings.

Material: Galvanised steel
Material thickness (mm): 0,6 mm
Norm: EN 14195:2005
Norm: DIN18182-1
Notes:
 Purchase only in full large packs possible.
 Special lengths on request

Item number	Description	Length (cm)	Order number	Width (mm)	Weight (kg/m/pc)	Package/ Large pack
5121	C 60-27	400	109895	60	0,570	12 PCS / 15 BUN

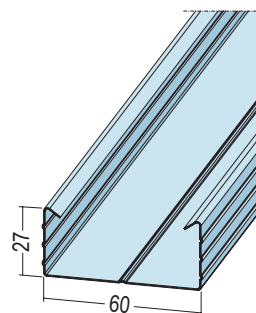

C-ceiling profile smooth with square return

Application area: hanging ceilings and wall facings.

Material: Galvanised steel
Material thickness (mm): 0,6 mm
Norm: EN 14195:2005
Norm: DIN18182-1
Notes:
 Purchase only in full large packs possible.
 Special lengths on request

Item number	Description	Length (cm)	Order number	Width (mm)	Weight (kg/m/pc)	Package/ Large pack
5128	C 60-27	400	109896	60	0,570	12 PCS / 15 BUN

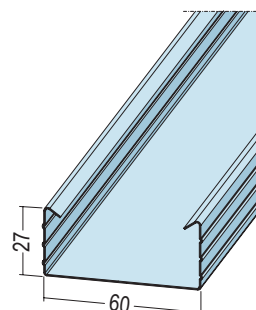

C-ceiling profile smooth with round return

Application area: hanging ceilings and wall facings.

Material: Galvanised steel
Material thickness (mm): 0,6 mm
Norm: EN 14195:2005
Norm: DIN18182-1
Notes:
 Purchase only in full large packs possible.
 Special lengths on request

Item number	Description	Length (cm)	Order number	Width (mm)	Weight (kg/m/pc)	Package/ Large pack
5101	C 60-27	400	112057	60	0,570	12 PCS / 15 BUN

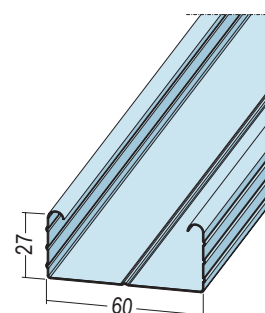

C-ceiling profile smooth with round return

Application area: hanging ceilings and wall facings.

Material: Galvanised steel
Material thickness (mm): 0,6 mm
Norm: EN 14195:2005
Norm: DIN18182-1
Notes:
 Purchase only in full large packs possible

 Special lengths on request

Item number	Description	Length (cm)	Order number	Width (mm)	Weight (kg/m/pc)	Package/ Large pack
5111	C 60-27	400	110098	60	0,570	12 PCS / 15 BUN

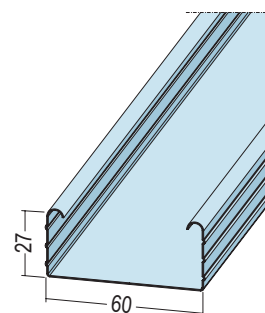

U connection profile

Application area: connection profile for hanging ceilings and wall facings.

Material: Galvanised steel
Material thickness (mm): 0,6 mm
Norm: EN 14195:2005
Norm: DIN18182-1
Notes:
 coated in white see article 53244
 coated in black see article 58122

Item number	Description	Length (cm)	Order number	Width (mm)	Weight (kg/m/pc)	Package/ Large pack
5244	U 28-27	300	109994	28,5	0,380	16 PCS / 28 BUN
	U 28-27	400	109995	28,5	0,380	16 PCS / 28 BUN

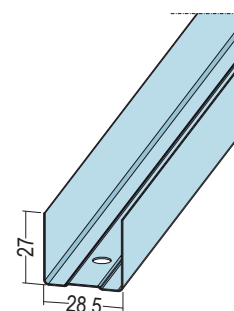

STANDARD CEILINGS AND WALLS

PRODUCT CLASS 6000

U connection profile

Application area: connection profile for hanging ceilings and wall facings.

Material: Galvanised steel
Material thickness (mm): 0,6 mm
Norm: EN 14195:2005
Norm: DIN18182-1
Notes:
 Coated in white see ref. 53168
 Coated in black see ref. 58168

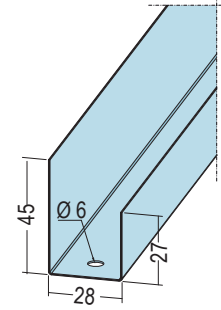

Item number	Description	Length (cm)	Order number	Width (mm)	Weight (kg/m/pc)	Package/ Large pack
5168	U 28-45 / 27	300	109947	28	0,469	16 PCS / 20 BUN

U-connection profile for constructions at same level

Application area: connection profile for level ceiling constructions for attaching safety cross connectors no. 6116.

Material: Galvanised steel
Material thickness (mm): 0,6 mm
Norm: EN 14195:2005
Norm: DIN18182-1

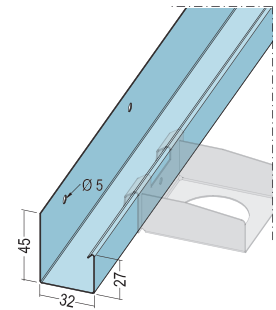

Item number	Description	Length (cm)	Order number	Width (mm)	Weight (kg/m/pc)	Package/ Large pack
5179	UD 28-45/27	300	100732	32	0,510	16 PCS / 20 BUN

Hat ceiling profile

Application area: ceilings and wall facings with very low installation height.

Material: Galvanised steel
Material thickness (mm): 0,6 mm
Norm: EN 14195:2005
Norm: DIN18168-2
Notes:
 Special lengths on request

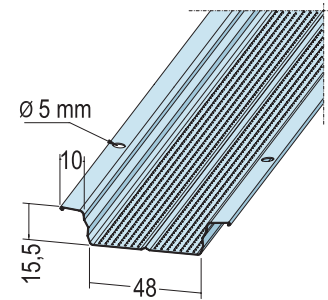

Item number	Description	Length (cm)	Order number	Width (mm)	Weight (kg/m/pc)	Package/ Large pack
5114	48-15,5	400	100112	48	0,471	10 PCS / 20 BUN

Hat ceiling profile

Application area: ceilings and wall facings with very low installation height.

Material: Galvanised steel
Material thickness (mm): 0,6 mm
Norm: EN 14195:2005
Norm: DIN18168-2

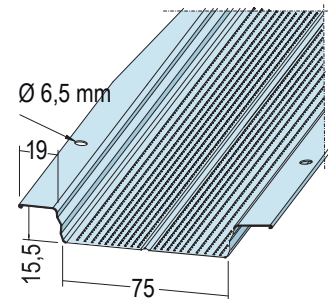

Item number	Description	Length (cm)	Order number	Width (mm)	Weight (kg/m/pc)	Package/ Large pack
50198	75,5-15,5	400	114770	75	0,655	10 PCS / 20 BUN

U connection profile for hat ceiling profile

Application area: connection profile for hat profiles (e.g. 5114 and 50198) on hanging ceilings and wall facings.

Material: Galvanised steel
Material thickness (mm): 0,6 mm
Norm: EN 14195:2005
Norm: DIN18182-1

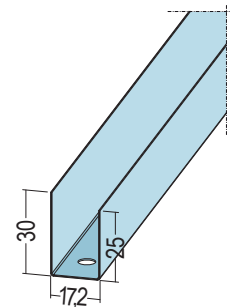

Item number	Description	Length (cm)	Order number	Width (mm)	Weight (kg/m/pc)	Package/ Large pack
5167	UD 17,2	300	100665	17,2	0,307	12 PCS / 50 BUN

STANDARD CEILINGS AND WALLS

PRODUCT CLASS 6000

C-stud

Application area: stand profile for walls/wall faces or support profile for free-spanning ceilings.
H cut-out at each end, continuously every 250 mm and subsequently every 500 mm.

Material: Galvanised steel
Material thickness (mm): 0,6 mm
Norm: EN 14195:2005
Norm: DIN18182-1
Notes:
Special lengths on request

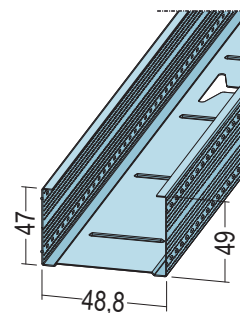

Item number	Description	Length (cm)	Order number	Width (mm)	Weight (kg/m/pc)	Package/ Large pack
5211	C 50-06	250	109948	48,8	0,706	8 PCS / 16 BUN
	C 50-06	260	109949	48,8	0,706	8 PCS / 16 BUN
	C 50-06	275	109950	48,8	0,706	8 PCS / 16 BUN
	C 50-06	300	109951	48,8	0,706	8 PCS / 16 BUN
	C 50-06	325	109952	48,8	0,706	8 PCS / 16 BUN
	C 50-06	350	109953	48,8	0,706	8 PCS / 16 BUN
	C 50-06	375	109954	48,8	0,706	8 PCS / 16 BUN
	C 50-06	400	109955	48,8	0,706	8 PCS / 16 BUN
	C 50-06	450	109957	48,8	0,706	8 PCS / 16 BUN
	C 50-06	500	109958	48,8	0,706	8 PCS / 16 BUN
	C 50-06	600	109959	48,8	0,706	8 PCS / 16 BUN

C-stud

Application area: stand profile for walls/wall faces or support profile for free-spanning ceilings.
H cut-out at each end, continuously every 250 mm and subsequently every 500 mm.

Material: Galvanised steel
Material thickness (mm): 0,6 mm
Norm: EN 14195:2005
Norm: DIN18182-1
Notes:
Fixlängen auf Anfrage

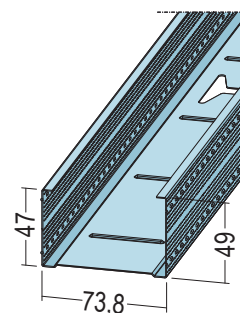

Item number	Description	Length (cm)	Order number	Width (mm)	Weight (kg/m/pc)	Package/ Large pack
5215	C 75-06	250	109961	73,8	0,820	8 PCS / 12 BUN
	C 75-06	260	109962	73,8	0,820	8 PCS / 12 BUN
	C 75-06	275	109963	73,8	0,820	8 PCS / 12 BUN
	C 75-06	300	109964	73,8	0,820	8 PCS / 12 BUN
	C 75-06	325	109965	73,8	0,820	8 PCS / 12 BUN
	C 75-06	350	109966	73,8	0,820	8 PCS / 12 BUN
	C 75-06	375	109968	73,8	0,820	8 PCS / 12 BUN
	C 75-06	400	109969	73,8	0,820	8 PCS / 12 BUN
	C 75-06	450	109971	73,8	0,820	8 PCS / 12 BUN
	C 75-06	500	109973	73,8	0,820	8 PCS / 12 BUN
	C 75-06	600	109975	73,8	0,820	8 PCS / 12 BUN

STANDARD CEILING AND WALLS

PRODUCT CLASS 6000

C-stud

Application area: stand profile for walls/wall faces or support profile for free-spanning ceilings.
H cut-out at each end, continuously every 250 mm and subsequently every 500 mm.

Material: Galvanised steel
Material thickness (mm): 0,6 mm
Norm: EN 14195:2005
Norm: DIN18182-1
Notes:
Fixlängen auf Anfrage

Item number	Description	Length (cm)	Order number	Width (mm)	Weight (kg/m/pc)	Package/ Large pack
5216	C 100-06	250	109976	98,8	0,929	8 PCS / 8 BUN
	C 100-06	260	109977	98,8	0,929	8 PCS / 8 BUN
	C 100-06	275	109978	98,8	0,929	8 PCS / 8 BUN
	C 100-06	300	109979	98,8	0,929	8 PCS / 8 BUN
	C 100-06	325	109980	98,8	0,929	8 PCS / 8 BUN
	C 100-06	350	109981	98,8	0,929	8 PCS / 8 BUN
	C 100-06	375	109982	98,8	0,929	8 PCS / 8 BUN
	C 100-06	400	109983	98,8	0,929	8 PCS / 8 BUN
	C 100-06	450	109985	98,8	0,929	8 PCS / 8 BUN
	C 100-06	500	109987	98,8	0,929	8 PCS / 8 BUN
	C 100-06	600	109989	98,8	0,929	8 PCS / 8 BUN

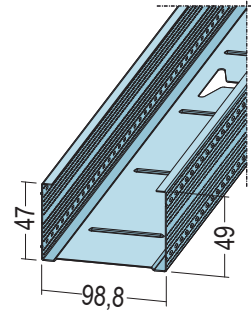

C-stud

Application area: stand profile for walls/wall faces or support profile for free-spanning ceilings.
H cut-out at each end, continuously every 250 mm and subsequently every 500 mm.

Material: Galvanised steel
Material thickness (mm): 0,6 mm
Norm: EN 14195:2005
Norm: DIN18182-1
Notes:
Fixlängen auf Anfrage

Item number	Description	Length (cm)	Order number	Width (mm)	Weight (kg/m/pc)	Package/ Large pack
5141	C 125-06	300	109943	123,8	1,066	8 PCS / 8 BUN
	C 125-06	400	109944	123,8	1,066	8 PCS / 8 BUN
	C 125-06	500	109946	123,8	1,066	8 PCS / 8 BUN
	C 125-06	600	113770	123,8	1,066	8 PCS / 8 BUN

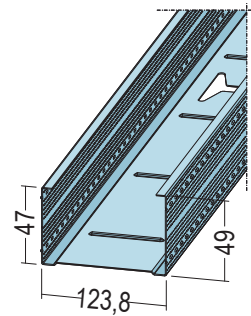

C-stud

Application area: stand profile for walls/wall faces or support profile for free-spanning ceilings.
H cut-out at each end, continuously every 250 mm and subsequently every 500 mm.

Material: Galvanised steel
Material thickness (mm): 0,6 mm
Norm: EN 14195:2005
Norm: DIN18182-1
Notes:
Fixlängen auf Anfrage

Item number	Description	Length (cm)	Order number	Width (mm)	Weight (kg/m/pc)	Package/ Large pack
5224	C 150-06	270	115623	148,8	1,161	4 PCS / 12 BUN
	C 150-06	400	109990	148,8	1,161	4 PCS / 12 BUN
	C 150-06	600	109991	148,8	1,161	4 PCS / 12 BUN

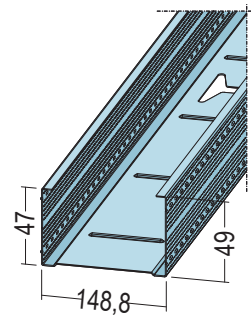

STANDARD CEILINGS AND WALLS

PRODUCT CLASS 6000

U-track

Application area: connection profile for walls/wall faces or for free-spanning ceilings.

Material: Galvanised steel
Material thickness (mm): 0,6 mm
Norm: EN 14195:2005
Norm: DIN18182-1

Item number	Description	Length (cm)	Order number	Width (mm)	Weight (kg/m/pc)	Package/ Large pack
5230	U 50-06	260	100854	50	0,580	8 PCS / 20 BUN
	U 50-06	300	109890	50	0,580	8 PCS / 20 BUN
	U 50-06	400	100892	50	0,580	8 PCS / 20 BUN

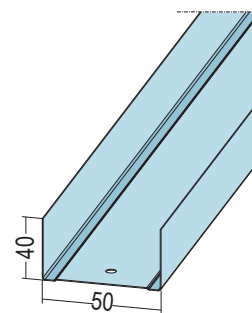

U-track

Application area: connection profile for walls/wall faces or for free-spanning ceilings.

Material: Galvanised steel
Material thickness (mm): 0,6 mm
Norm: EN 14195:2005
Norm: DIN18182-1

Item number	Description	Length (cm)	Order number	Width (mm)	Weight (kg/m/pc)	Package/ Large pack
5233	U 75-06	260	100951	75	0,690	8 PCS / 15 BUN
	U 75-06	300	109889	75	0,690	8 PCS / 15 BUN
	U 75-06	400	100952	75	0,690	8 PCS / 15 BUN

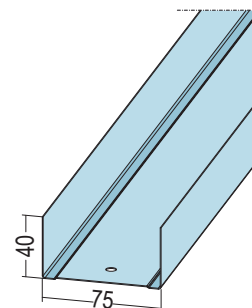

U-track

Application area: connection profile for walls/wall faces or for free-spanning ceilings.

Material: Galvanised steel
Material thickness (mm): 0,6 mm
Norm: EN 14195:2005
Norm: DIN18182-1

Item number	Description	Length (cm)	Order number	Width (mm)	Weight (kg/m/pc)	Package/ Large pack
5234	U 100-06	260	100954	100	0,806	8 PCS / 10 BUN
	U 100-06	300	109891	100	0,806	8 PCS / 10 BUN
	U 100-06	400	100957	100	0,806	8 PCS / 10 BUN

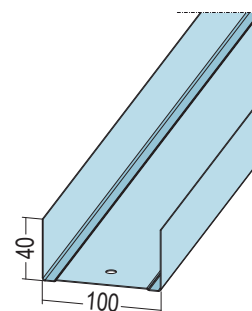

U-track

Application area: connection profile for walls/wall faces or for free-spanning ceilings.

Material: Galvanised steel
Material thickness (mm): 0,6 mm
Norm: EN 14195:2005
Norm: DIN18182-1

Item number	Description	Length (cm)	Order number	Width (mm)	Weight (kg/m/pc)	Package/ Large pack
5248	U 125-06	400	109997	125	0,880	4 PCS / 15 BUN

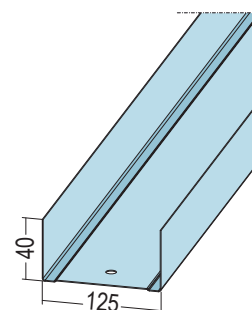

U-track

Application area: connection profile for walls/wall faces or for free-spanning ceilings.

Material: Galvanised steel
Material thickness (mm): 0,6 mm
Norm: EN 14195:2005
Norm: DIN18182-1

Item number	Description	Length (cm)	Order number	Width (mm)	Weight (kg/m/pc)	Package/ Large pack
5247	U 150-06	400	109996	150	0,980	4 PCS / 15 BUN

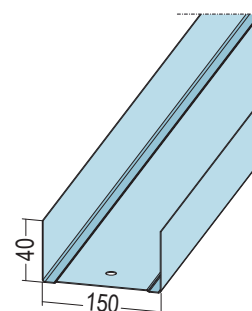

STANDARD CEILING AND WALLS

PRODUCT CLASS 6000

U Reinforcing profile

Application area: walls/wall faces, especially in door areas, or support profiles for free-hanging ceilings.

Material: Galvanised steel
Material thickness (mm): 2 mm
Norm: EN 14195:2005
Norm: DIN18182-1
Notes:
 Fixlängen auf Anfrage

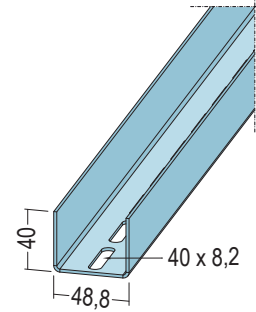

Item number	Description	Length (cm)	Order number	Width (mm)	Weight (kg/m/pc)	Package/ Large pack
5129	U 50-20	250	109897	48,8	1,770	6 PCS / 15 BUN
	U 50-20	260	109898	48,8	1,770	6 PCS / 15 BUN
	U 50-20	275	109899	48,8	1,770	6 PCS / 15 BUN
	U 50-20	300	109900	48,8	1,770	6 PCS / 15 BUN
	U 50-20	325	109901	48,8	1,770	6 PCS / 15 BUN
	U 50-20	350	109902	48,8	1,770	6 PCS / 15 BUN
	U 50-20	375	109903	48,8	1,770	6 PCS / 15 BUN
	U 50-20	400	109904	48,8	1,770	6 PCS / 15 BUN
	U 50-20	450	109906	48,8	1,770	6 PCS / 15 BUN
	U 50-20	500	109907	48,8	1,770	6 PCS / 15 BUN
	U 50-20	600	113734	48,8	1,770	6 PCS / 15 BUN

U Reinforcing profile

Application area: walls/wall faces, especially in door areas, or support profiles for free-hanging ceilings.

Material: Galvanised steel
Material thickness (mm): 2 mm
Norm: EN 14195:2005
Norm: DIN18182-1
Notes:
 Fixlängen auf Anfrage

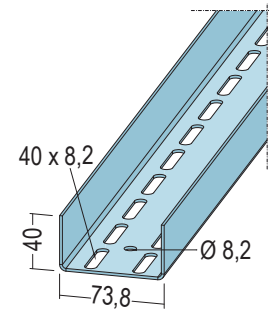

Item number	Description	Length (cm)	Order number	Width (mm)	Weight (kg/m/pc)	Package/ Large pack
5130	U 75-20	250	109908	73,8	1,990	4 PCS / 25 BUN
	U 75-20	260	109909	73,8	1,990	4 PCS / 25 BUN
	U 75-20	275	109910	73,8	1,990	4 PCS / 25 BUN
	U 75-20	300	109911	73,8	1,990	4 PCS / 25 BUN
	U 75-20	325	109912	73,8	1,990	4 PCS / 25 BUN
	U 75-20	350	109913	73,8	1,990	4 PCS / 25 BUN
	U 75-20	375	109914	73,8	1,990	4 PCS / 25 BUN
	U 75-20	400	109915	73,8	1,990	4 PCS / 25 BUN
	U 75-20	450	109917	73,8	1,990	4 PCS / 25 BUN
	U 75-20	500	109919	73,8	1,990	4 PCS / 25 BUN
	U 75-20	600	109921	73,8	1,990	4 PCS / 25 BUN

STANDARD CEILINGS AND WALLS

PRODUCT CLASS 6000

U Reinforcing profile

Application area: walls/wall faces, especially in door areas, or support profiles for free-hanging ceilings.

Material: Galvanised steel
Material thickness (mm): 2 mm
Norm: EN 14195:2005
Norm: DIN18182-1
Notes:
 Fixlängen auf Anfrage

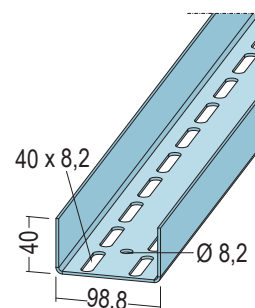

Item number	Description	Length (cm)	Order number	Width (mm)	Weight (kg/m/pc)	Package/ Large pack
5131	U 100-20	260	100914	98,8	2,485	4 PCS / 15 BUN
	U 100-20	275	102974	98,8	2,485	4 PCS / 15 BUN
	U 100-20	300	100513	98,8	2,485	4 PCS / 15 BUN
	U 100-20	325	103589	98,8	2,485	4 PCS / 15 BUN
	U 100-20	350	100522	98,8	2,485	4 PCS / 15 BUN
	U 100-20	375	104128	98,8	2,485	4 PCS / 15 BUN
	U 100-20	400	100528	98,8	2,485	4 PCS / 15 BUN
	U 100-20	450	103465	98,8	2,485	4 PCS / 15 BUN
	U 100-20	500	103466	98,8	2,485	4 PCS / 15 BUN
	U 100-20	600	103468	98,8	2,485	4 PCS / 15 BUN

U Reinforcing profile

Application area: walls/wall faces, especially in door areas, or support profiles for free-hanging ceilings.

Material: Galvanised steel
Material thickness (mm): 2 mm
Norm: EN 14195:2005
Norm: DIN18182-1
Notes:
 Fixlängen auf Anfrage

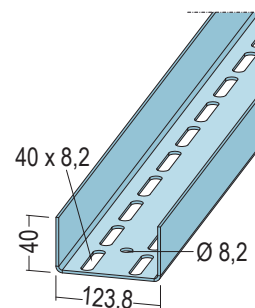

Item number	Description	Length (cm)	Order number	Width (mm)	Weight (kg/m/pc)	Package/ Large pack
5132	U 125-20	400	109938	123,8	2,870	2 PCS / 30 BUN
	U 125-20	500	109939	123,8	2,870	2 PCS / 30 BUN
	U 125-20	600	109940	123,8	2,870	2 PCS / 30 BUN

U Reinforcing profile

Application area: walls/wall faces, especially in door areas, or support profiles for free-hanging ceilings.

Material: Galvanised steel
Norm: EN 14195:2005
Norm: DIN18182-1
Notes:
 Fixlängen auf Anfrage

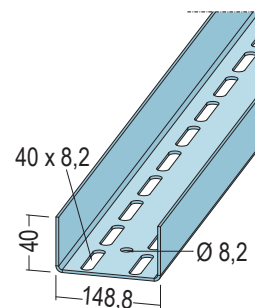

Item number	Description	Length (cm)	Order number	Width (mm)	Weight (kg/m/pc)	Package/ Large pack
5140	U 150-20	400	114620	148,8	3,310	2 PCS / 24 BUN
	U 150-20	500	114603	148,8	3,310	2 PCS / 24 BUN
	U 150-20	600	114605	148,8	3,310	2 PCS / 24 BUN
	U 150-20	700	118451	148,8	3,310	2 PCS / 24 BUN

STANDARD CEILINGS AND WALLS

PRODUCT CLASS 6000

U Reinforcing profile unperforated

Application area: walls/wall faces, especially in door areas, or support profiles for free-hanging ceilings.

Material: Galvanised steel
Material thickness (mm): 2 mm
Norm: EN 14195:2005
Norm: DIN18182-1
Notes:
 Fixlängen auf Anfrage

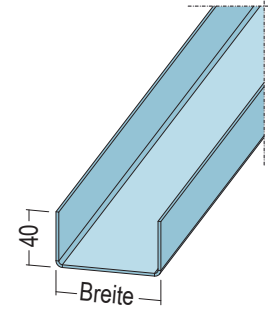

Item number	Description	Length (cm)	Order number	Width (mm)	Weight (kg/m/pc)	Package/ Large pack
5149	UA 50-20	300	112385	48,8	1,770	6 PCS / 15 BUN
	UA 50-20	400	112386	48,8	1,770	6 PCS / 15 BUN
5150	UA 75-20	300	112387	73,8	1,990	4 PCS / 25 BUN
	UA 75-20	400	112388	73,8	1,990	4 PCS / 25 BUN
5151	UA 100-20	300	112389	98,8	2,485	4 PCS / 15 BUN
	UA 100-20	400	112390	98,8	2,485	4 PCS / 15 BUN
5152	UA 125-20	400	114944	123,8	2,870	2 PCS / 30 BUN

U-connecting profile

Application area: connection profile for UA profiles on free-spanning ceilings.

Material: S320 GD+Z
Material thickness (mm): 2 mm
Norm: EN 14195:2005
Norm: DIN18182-1
Notes:
 Fixlängen auf Anfrage

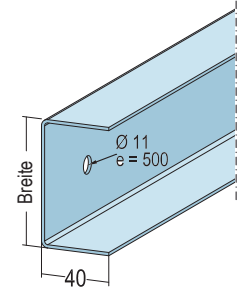

Item number	Description	Length (cm)	Order number	Width (mm)	Weight (kg/m/pc)	Package/ Large pack
5512	for UA 50	400	115983	52,8	1,939	1 PCS / 198 PCS
5513	for UA 75	400	111302	77,8	2,496	1 PCS / 98 PCS
5514	for UA 100	400	111303	102,8	2,865	1 PCS / 102 PCS
5515	for UA 125	400	111304	127,8	3,155	1 PCS / 100 PCS
5516	for UA 150	400	111306	152,8	3,548	1 PCS / 100 PCS



ATTUNED TO YOUR NEEDS

PROTEKTOR offers many specialist products to enable creating superstructures, curves, arches and connections.

For example the GR-connection profile for convex and/or concave curved wall and ceiling constructions, RS-wall profiles or special profiles for door frames.

SPECIAL PRODUCTS

PRODUCT CLASS 6640

U connection profile white

Application area: connection profile for hanging ceilings with white shadow joints.
White outer side, RAL 9010.

Material: Galvanised steel, with white basic coating
Material thickness (mm): 0,6 mm
Norm: EN 14195
Norm: DIN18182-1

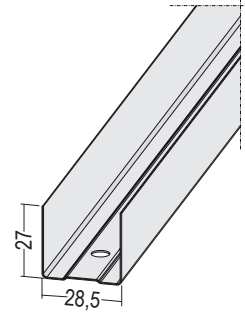

Item number	Description	Length (cm)	Order number	Width (mm)	Weight (kg/m/pc)	Package/ Large pack
53244	U 28-27	300	112189	28,5	0,380	16 PCS / 28 BUN

U connection profile white with uneven wings

Application area: connection profile for hanging ceilings with white shadow joints.
White outer side, RAL 9010.

Material: Galvanised steel, with white basic coating
Material thickness (mm): 0,6 mm
Norm: EN 14195
Norm: DIN18182-1

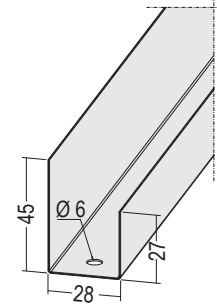

Item number	Description	Length (cm)	Order number	Width (mm)	Weight (kg/m/pc)	Package/ Large pack
53168	U 28-45 /27	300	112190	28	0,469	16 PCS / 20 BUN

Grid angle

For universal uses.
*Distance between perforations may vary due to production constraints.

Material: Galvanised steel
Material thickness (mm): 2 mm
Norm: EN 14195:2005
DIN test standard: DIN 18168-2
Notes:
Standard holes only on request

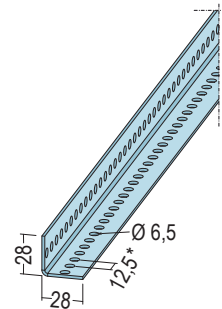

Item number	Description	Length (cm)	Order number	Width (mm)	Weight (kg/m/pc)	Package/ Large pack
5178	28 x 28 mm	400	100726	28	0,760	8 PCS / 25 BUN

Inside corner profile 90°LWi

Application area: for the inner corner of walls.

Material: Galvanised steel
Material thickness (mm): 0,6 mm
Norm: EN 14195:2005
Norm: DIN18182-1
Notes:
Special lengths on request

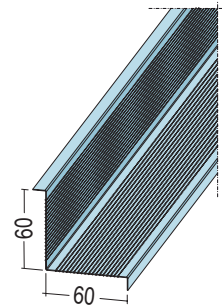

Item number	Description	Length (cm)	Order number	Width (mm)	Weight (kg/m/pc)	Package/ Large pack
5170	LWi 60 x 60	300	100689		0,631	10 PCS / 40 BUN

Flexible angle profile

Area of application for forming wall corners or for transitions in roof slopes. The flexible angle profile can be cut to the desired length on site and bent by hand to the required angle positions.

Material: Galvanised steel
Material thickness (mm): 0,6 mm



Item number	Description	Length (cm)	Order number	Width (mm)	Weight (kg/m/pc)	Package/ Large pack
5450	100 mm	2,500	117684	100	0,471	1 PC / 44 BOX

SPECIAL PRODUCTS

PRODUCT CLASS 6640

U-wall profile UW

Application area: connection profile for walls/wall faces with sliding ceiling connections.

Material: Galvanised steel
Material thickness (mm): 0,6 mm
Norm: EN 14195
Norm: DIN18182-1

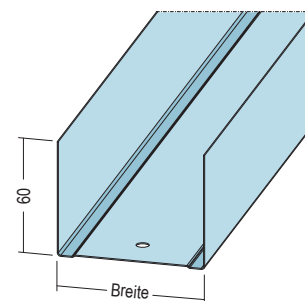

Item number	Description	Length (cm)	Order number	Width (mm)	Weight (kg/m/pc)	Package/ Large pack
5236	U 60 x 50 x 60	400	100960	50	0,918	4 PCS / 100 BUN
5237	U 60 x 75 x 60	400	100962	75	1,055	4 PCS / 70 BUN
5238	U 60 x 100 x 60	400	100963	100	1,192	4 PCS / 50 BUN
NEW 5239	U 60 x 125 x 60	400	119413	125	1,320	4 PCS / 50 BUN

Drywall furring profile

Application area: mounting construction panels on walls/wall facings.

Material: Galvanised steel
Material thickness (mm): 0,6 mm
Norm: EN 14195

Do not use as a ceiling sub-construction!

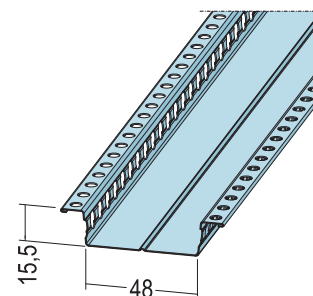

Item number	Description	Length (cm)	Order number	Width (mm)	Weight (kg/m/pc)	Package/ Large pack
5112	48-15.5	230	100109	48	0,414	10 PCS / 20 BUN

Hat profile

Application area: walls/wall facings for attaching construction panels as a clamp system or as a mounting rail for nut/spring clips.

Material: Galvanised steel
Material thickness (mm): 0,6 mm
Norm: EN 14195:2005

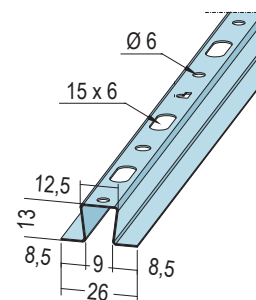

Item number	Description	Length (cm)	Order number	Width (mm)	Weight (kg/m/pc)	Package/ Large pack
5143	13 x 26 mm	300	100608	26	0,231	15 PCS / 100 BUN

Hat profile

Application area: walls/wall facings for mounting construction panels as a clamping system.

Material: Galvanised steel
Material thickness (mm): 0,6 mm
Norm: EN 14195

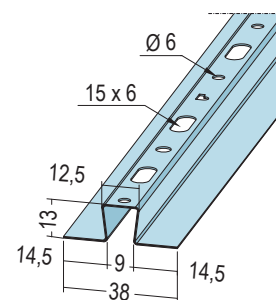

Item number	Description	Length (cm)	Order number	Width (mm)	Weight (kg/m/pc)	Package/ Large pack
5156	13 x 38 mm	300	100620	38	0,284	15 PCS / 100 BUN

Covering strip

Application area: walls/wall facings as a coverage profile in connection with hat profile no. 5143.

Material: PVC
Notes:
 Special colour on demand min. 1000 m

10 white, 22 grey

Item number	Description	Length (cm)	Colour	Order number	Width (mm)	Weight (kg/m/pc)	Package/ Large pack
	12 x 33 mm	300	10 - white	100073	33	0,140	15 PCS / 95 BUN
3762	12 x 33 mm	300	BN - light grey	116985	33	0,140	15 PCS / 95 BUN
	12 x 33 mm	300	91 - anthracite	118481	33	0,140	15 PCS / 95 BUN

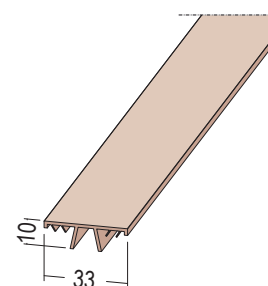

SPECIAL PRODUCTS

PRODUCT CLASS 6640

Covering strip

Application area: walls/wall facings as a coverage profile in connection with hat profile no. 5156.

Material: PVC

10 white

Item number	Description	Length (cm)	Colour	Order number	Width (mm)	Weight (kg/m/pc)	Package/ Large pack
3765	12 x 56 mm	300	10 - white	112188	56	0,210	15 PCS / 52 BUN

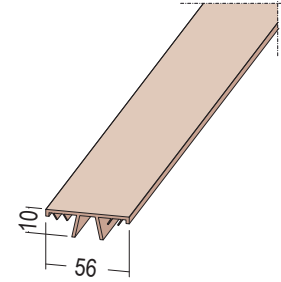

Covering strip E6 EV 1 anodised

Application area: walls/wall facings as a coverage profile in connection with hat profile no. 5143.

Material: Aluminum, anodized

Item number	Description	Length (cm)	Order number	Width (mm)	Weight (kg/m/pc)	Package/ Large pack
6578	8 x 37 mm	300	116478	37	0,240	15 PCS / 100 BUN

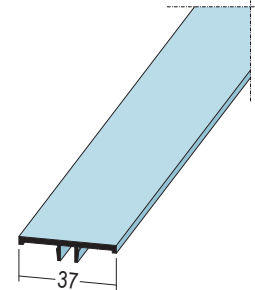

Filling profile

Application area: walls/wall facings as a coverage profile in connection with hat profile no. 5143 or 6549.

Material: PVC

Material thickness (mm): 1,4 mm

10 white

Item number	Description	Length (cm)	Colour	Order number	Width (mm)	Weight (kg/m/pc)	Package/ Large pack
3655	for Item no. 6549	300	10 - white	103340	10	0,052	20 PCS / 262 BUN

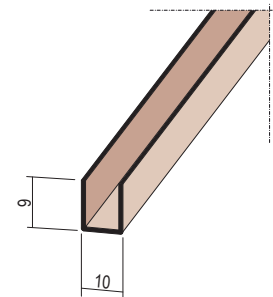

Tongue and groove board pivot clip galvanised

Application area: ceilings and walls for tongue and groove boards in combination with hat profile no. 5143.

Material: Galvanised steel

Item number	Description	Length (cm)	Order number	Width (mm)	Weight (kg/m/pc)	Package/ Large pack
6146	groove 3 mm	0	101396		0,006	250 PC / 80 BOX
SALE 6144	groove 4 mm	0	101391		0,006	250 PC / 80 BOX
6148	groove 5 mm	0	100862		0,006	250 PC / 80 BOX

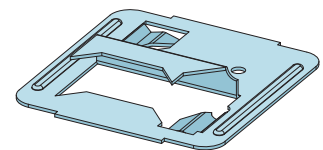

Aluminium hat profile anodised E6 EV1

Application area: walls/wall facings for mounting construction panels as a clamping system.

Material: Aluminum, anodized

Material thickness (mm): 1,5 mm

Item number	Description	Length (cm)	Order number	Width (mm)	Weight (kg/m/pc)	Package/ Large pack
6549	9 x 30 mm	300	118341	30	0,200	20 PCS / 66 BUN

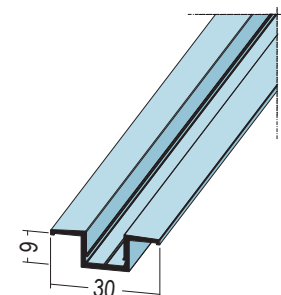

SPECIAL PRODUCTS

PRODUCT CLASS 6640

Beam levelling bracket profile

Application area: exposed beam ceilings or attic extensions.

Material: Galvanised steel
Material thickness (mm): 0,7 mm

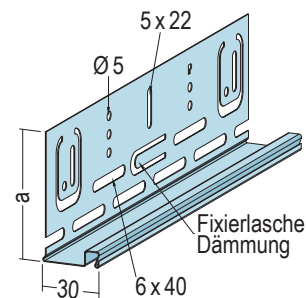

Item number	Description	Length (cm)	Order number	Width (mm)	Weight (kg/m/pc)	Package/ Large pack
5570	100 x 30 mm	260	112183	100	0,731	8 PCS / 40 BUN

Piping profile

Beading profile for attaching vapour barrier connected with levelling bracket 5570.

Material: PVC
Notes:
 60 keder profiles are required per bundle of with levelling brackets.

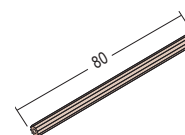

Item number	Description	Length (cm)	Order number	Width (mm)	Weight (kg/m/pc)	Package/ Large pack
5580	80 mm	8	107340		0,001	60 PC / 60 BEU

Beam levelling adapter

Application area: extending installation height of beam levelling bracket profile up to max. 165 mm, plus beam/rafter height.

Material: Galvanised steel
Material thickness (mm): 0,8 mm



Item number	Description	Length (cm)	Order number	Width (mm)	Weight (kg/m/pc)	Package/ Large pack
5575	for 5570	0	115039		0,038	100 PC / 30 BOX

Angle profile

For universal uses.

Material: Galvanised steel
Material thickness (mm): 0,6 mm
Norm: EN 14195
Notes:
 More dimensions of angle profiles upon request

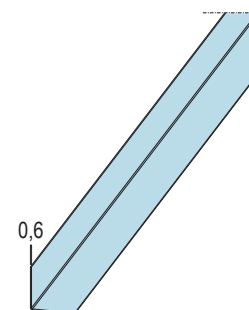

Item number	Description	Length (cm)	Order number	Width (mm)	Weight (kg/m/pc)	Package/ Large pack
5161	28 x 28 mm	300	106601	28	0,237	20 PCS / 50 BUN
5162	41 x 41 mm	400	100654	40	0,351	20 PCS / 50 BUN

Angle profile

For universal uses.

Material: Galvanised steel
Material thickness (mm): 0,7 mm
Norm: EN 14195
Notes:
 More dimensions of angle profiles upon request

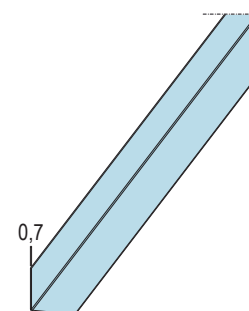

Item number	Description	Length (cm)	Order number	Width (mm)	Weight (kg/m/pc)	Package/ Large pack
5186	30 x 50 mm	300	110249	50	0,428	20 PCS / 55 BUN

SPECIAL PRODUCTS

PRODUCT CLASS 6640

Angle profile

For universal uses.

Material: Galvanised steel
Material thickness (mm): 1 mm
Norm: EN 14195
Notes:
 More dimensions of angle profiles upon request

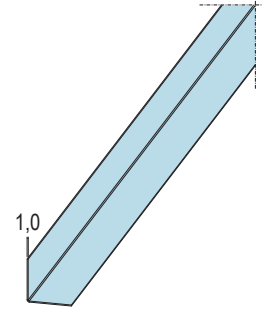

Item number	Description	Length (cm)	Order number	Width (mm)	Weight (kg/m/pc)	Package/ Large pack
5189	30 x 30 mm	300	110251	30	0,451	10 PCS / 50 BUN
5165	40 x 20 mm	300	100663	20	0,451	8 PCS / 60 BUN
5177	40 x 40 mm	300	100723	40	0,620	10 PCS / 50 BUN
5194	50 x 50 mm	300	110654	50	0,777	10 PCS / 40 BUN

Aluminium inspection flap with 12.5 mm GKBI

Application area for ceiling and wall as opening for maintenance and installation work. With 12.5 mm GKBI, filled.

Material: Plasterboard with aluminium
Notes:
 Construction opening dimension approx. 3 - 5 mm larger than nominal dimension



Item number	Description	Order number	Width (mm)	Weight (kg/m/pc)	Package/ Large pack
6765	20 x 20 cm	118909		0,900	1 PC / 60 BOX
6766	30 x 30 cm	118915		1,600	1 PC / 56 BOX
6767	40 x 40 cm	118916		2,440	1 PC / 52 BOX
6768	50 x 50 cm	118917		3,500	1 PC / 30 BOX
6769	60 x 60 cm	118918		4,750	1 PC / 13 BOX

Inspection flap made of painted steel with snap lock

Application area for ceiling and wall as opening for maintenance and installation work. White lacquered.

Material: Galvanised steel with coating
Notes:
 Construction opening dimension approx. 3 - 5 mm larger than nominal dimension



Item number	Description	Order number	Width (mm)	Weight (kg/m/pc)	Package/ Large pack
6727	20 x 20 cm	114926		0,518	1 PC / 116 BOX
6732	30 x 30 cm	114927		1,498	1 PC / 12 BOX
6733	40 x 40 cm	114928		2,750	1 PC / 56 BOX
6735	50 x 50 cm	114929		2,330	1 PC / 14 BOX
6736	60 x 60 cm	114930		3,018	1 PC / 32 BOX

Wall niches with special waterproof coating

Can be used for both drywall constructions and solid walls. Mounting element for niche-shaped storage spaces, tileable and waterproof

Material: Polystyrene

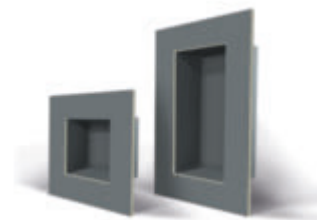

Item number	Description	Length (cm)	Order number	Width (mm)	Weight (kg/m/pc)	Package/ Large pack
57260	200/400	0	119551		1,500	1 PC / 40 BOX
57261	300/600	0	119552		1,800	1 PC / 20 BOX

SPECIAL PRODUCTS

PRODUCT CLASS 6640

multifunctional adhesive and sealant

Material:



Item number	Description	Length (cm)	Order number	Width (mm)	Weight (kg/m/pc)	Package/ Large pack
57265	for wall niches	27	119550		0,450	1 PC / 12 PC

PROTEKTOR BEAM LEVELLING BRACKET PROFILE

MORE SPACE FOR ROOF INSULATION



THE SOLUTION PROVIDER FOR OLD AND NEW CONSTRUCTIONS

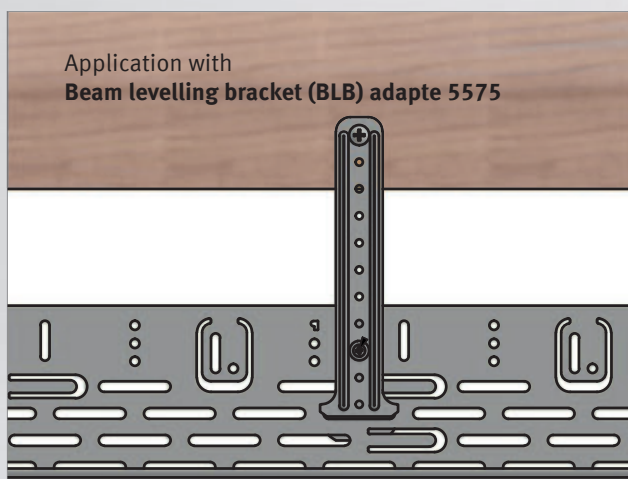

Saving energy is an important factor when redeveloping, updating and renovating. More and more old buildings are being fitted with increased insulation and new internal floors and walls under sloping roofs.

Those carrying out the work repeatedly face the same problems. Inadequate rafter height that does not support the required thickness of insulation and means that under rafter insulation is needed. Uneven wooden beams or rafters make the installation of close-fitting planking on sloping roofs and wooden rafters a veritable jigsaw puzzle. The solution for these applications is the new rafter levelling angle profile from PROTEKTOR.

- ▶ Awarded the “Product innovation building in our heritage” at BAU 2007
- ▶ Precise adjustment of the profile using slot-shaped holes and pre-stamped right-angle brackets
- ▶ Under rafter insulation secured against slipping
- ▶ Simple job to fit the damp-proof membrane

Beam levelling bracket (BLB) adapte 5575
The BLB adapter, combined with profiles, provides up to 165 mm available height on top of the rafter/beam height. This allows significantly

PROTEKTOR BEAM-NEVILLIERWINKELPROFIL
MEHR AUFBAUHÖHE FÜR DIE DACHDÄMMUNG (GEM. PATENT ANGEWELDET)

Bei den Balken-Neveillierwinkelprofilen handelt es sich um mehrfach abgewinkelte Profile aus verzinktem Stahl. Sie sind anwendungsspezifisch systemlösungsorientiert. Sie werden eingesetzt, um zum Beispiel ein höher liegendes Dachstuhl mit den vorhandenen unteren Dachstuhlbauteilen anzugleichen. Die Profile sind dabei so konstruiert, dass sie sich an die unterschiedlichen Höhen der vorhandenen Dachstuhlbauteile anpassen lassen. Durch die Verwendung der Profile wird die Dacheindeckung über die gesamte Länge der Dachstuhlbauteile hinweg gesichert. Die Profile sind dabei so konstruiert, dass sie sich an die unterschiedlichen Höhen der vorhandenen Dachstuhlbauteile anpassen lassen. Durch die Verwendung der Profile wird die Dacheindeckung über die gesamte Länge der Dachstuhlbauteile hinweg gesichert.

Die einzelnen Profile sind, die in die Profile eingetragenen Längs- und Stützbohrungen, sowie die in den Profilen eingetragenen Aussparungen, anwendungsspezifisch konstruiert.

Ziele bei Anwendung unserer Langschienen (LS):

- ▶ zur Verankerung von LS- und Klebefolien
- ▶ Verankerung durch einen dichten Klebefolienrand
- ▶ als Stützbohrung zum Einbau von schief liegenden Deckenbalken oder Stützen

Längsbohrung innerhalb der Langschienen (LS):

- ▶ wird bei Bedarf aus dem Profil heraus ausgefräst und verbleibt als angeglichene Abzweigung der zweiten Dämmstoffebene

Stützbohrung innerhalb der Langschienen (LS):

- ▶ zur Verankerung und Lötung
- ▶ zur Verankerung einer Klebefolienbohrung

Ausgewählte Aussparungen in der Befestigungsbohrung (B):

- ▶ lassen sich bei Bedarf für die Einbringung von Klebefolien in der Befestigungsbohrung einfräsen

Profil aus Aluminium anstatt des Profilschleifens (P):

- ▶ ist für die Verwendung in der Dachstuhlbauteile (Dachstuhl) in der Befestigungsbohrung geeignet

Product video
View now »



DRY LINING

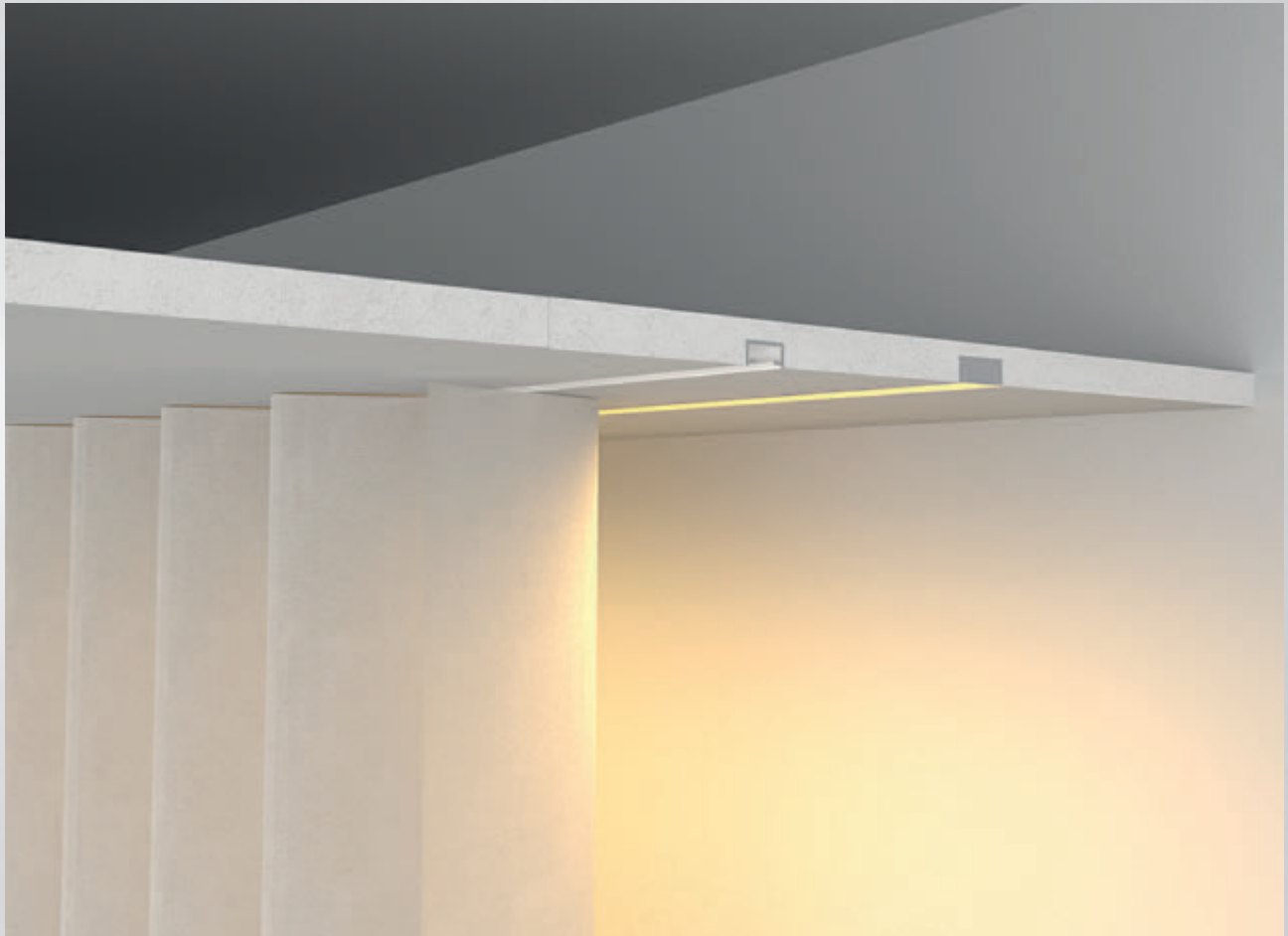

DESIGN ELEMENTS: PRECISELY PREFABRICATED FOR PERFECT RESULTS

Preformed parts play a decisive role in the realisation of high-quality construction projects by providing a tailor-made solution for functional applications. They are an essential element in modern drywall construction and offer an efficient solution for many applications, particularly in the design of ceilings and walls. They enable quick installation and contribute to considerable time savings.

Advantages:

- ▶ Perfect design and high quality
- ▶ Simple assembly
- ▶ Time-saving realisation
- ▶ Attractive and precise results

PREFORMED PARTS

PRODUCT CLASS 6100

Curtain system GRP 12.5 mm single track

Plasterboard with integrated white VS57 curtain profile, single track.
Protective cover included.
Edge distance: 70 / 100 mm

Material: Plasterboard with aluminium
Notes:
Max. load per curtain rail 7 kg / m
Please order stopper set 57238 and connector 57237 separately

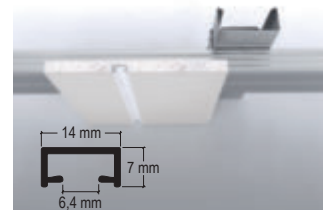

Item number	Description	Length (cm)	Order number	Width (mm)	Weight (kg/m/pc)	Package/ Large pack
NEW 57230	12,5 mm	200	119547		5,000	10 PC / 4 BUN

Corner piece for single track curtain system

Corner piece, simple-track, for plasterboard with integrated white VS57 curtain profile.
Protective cover included.

Material: Plasterboard with aluminium
Notes:
Max. load per curtain rail 7 kg / m

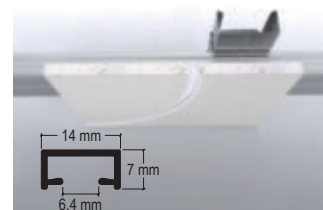

Item number	Description	Length (cm)	Order number	Width (mm)	Weight (kg/m/pc)	Package/ Large pack
NEW 57235	GFK 12,5 mm	0	119554		3,200	1 PC / 10 BUN

Curtain system 12.5 mm double track

Plasterboard with integrated white VS57 curtain profile, double track.
Protective cover included.
Edge distance: 70 / 70 / 100 mm

Material: Plasterboard with aluminium
Notes:
Max. load per curtain rail 7 kg / m
Please order stopper set 57238 and connector 57237 separately

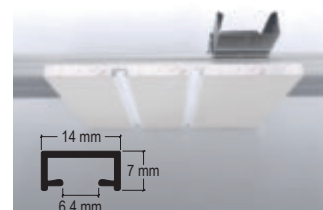

Item number	Description	Length (cm)	Order number	Width (mm)	Weight (kg/m/pc)	Package/ Large pack
NEW 57234	GKF 12,5	200	119548		6,500	10 PC / 5 BUN

Corner piece for double track curtain system

Corner piece, double-track, for plasterboard with integrated white VS57 curtain profile.
Protective cover included.

Material: Plasterboard with aluminium
Notes:
Max. load per curtain rail 7 kg / m

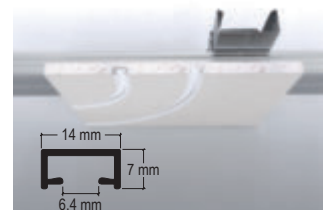

Item number	Description	Length (cm)	Order number	Width (mm)	Weight (kg/m/pc)	Package/ Large pack
NEW 57236	GKF 12,5 mm	0	119555		3,500	1 PC / 10 BUN

Interconnects

For longitudinal connection of the GKF 12.5 mm curtain system, single and double track

Material: Spring steel, galvanized



Item number	Description	Length (cm)	Order number	Width (mm)	Weight (kg/m/pc)	Package/ Large pack
NEW 57237	for curtain rail	4	119945		0,002	1 PC / 1 BEU

PREFORMED PARTS

PRODUCT CLASS 6100

Stopper set

Stopper set for curtain rails consisting of 10 stoppers and a drilling template **Material:** PE



Item number	Description	Length (cm)	Order number	Width (mm)	Weight (kg/m/pc)	Package/ Large pack
NEW 57238	for curtain rails	0	120116		0,009	1 PC / 1000 BEU

3-layer bonded gypsum blocks, 12,5 mm

For use in wall areas with sliding ceiling connections and where increased sound insulation is required. **Material:** Plasterboard
Norm: EN 14190:2014



Item number	Description	Length (cm)	Order number	Width (mm)	Weight (kg/m/pc)	Package/ Large pack
NEW 57100	50 mm	200	119343		2,550	8 PC / 30 BOX
NEW 57101	75 mm	200	119344		3,825	8 PC / 20 BOX
NEW 57102	100 mm	200	119345		5,100	6 PC / 20 BOX

STANDARD ACCESSOIRES FOR WALLS AND CEILINGS

PRODUCT CLASS 6500



QUALITY IS ALWAYS A GOOD FIT

Whether you are connecting, fixing, tensioning, adjusting or hanging – PROTEKTOR accessories are always a smart solution. The perfect compatibility of the components with each other makes work easier and ensures high-quality results.

STANDARD ACCESSOIRES

PRODUCT CLASS 6500

Quick cross-connector

For creating cross connections of CD profiles on hanging ceiling sub-constructions.

Material: Galvanised steel
Material thickness (mm): 0,7 mm
Norm: EN 13964:2014
Norm: DIN18168-2
Load carrying class: 0,40 kN

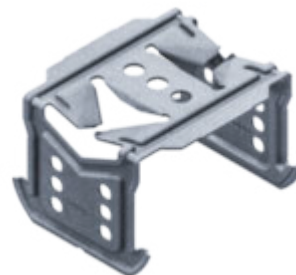

Item number	Description	Order number	Width (mm)	Weight (kg/m/pc)	Package/ Large pack
6102	for C 60-27	108534		0,040	100 PC / 45 BOX

Flat quick cross-connector

For creating cross connections of CD profiles on hanging ceiling sub-constructions.

Material: Galvanised steel
Material thickness (mm): 0,8 mm
Norm: EN 13964:2014
Norm: DIN18168-2
Load carrying class: 0,40 kN

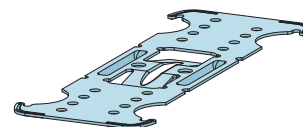

Item number	Description	Order number	Width (mm)	Weight (kg/m/pc)	Package/ Large pack
6105	for C 60-27	103182		0,054	100 PC / 270 BOX

Flat quick cross-connector

For creating cross connections from UA-50 to CD 60-27 profiles on hanging ceiling sub-constructions.

Material: Galvanised steel
Material thickness (mm): 0,9 mm
Norm: EN 13964:2014
Norm: DIN18168-2
Load carrying class: 0,40 kN



Item number	Description	Order number	Width (mm)	Weight (kg/m/pc)	Package/ Large pack
6100	for U50 to C 60-27	101259		0,042	100 PC / 250 BOX

Angle anchor

For creating cross connections of CD profiles on hanging ceiling sub-constructions. Always to be fitted in pairs and pressed together using pliers.

Material: Galvanised steel
Material thickness (mm): 1 mm
Norm: EN 13964:2014
Norm: DIN18168-2
Load carrying class: 0,25 kN/Pair

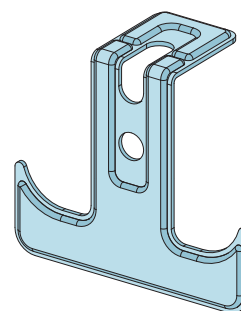

Item number	Description	Order number	Width (mm)	Weight (kg/m/pc)	Package/ Large pack
6090	for C 60-27	114751		0,020	100 PC / 120 BOX

C-ceiling profile connector

For connecting CD 60-27 profiles lengthwise.

Material: Galvanised steel
Material thickness (mm): 0,5 mm

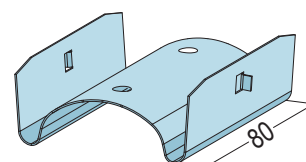

Item number	Description	Length (cm)	Order number	Width (mm)	Weight (kg/m/pc)	Package/ Large pack
6078	for C 60-27	8	107904		0,038	100 PC / 45 BOX

STANDARD ACCESSOIRES

PRODUCT CLASS 6500

C-ceiling profile connector

For connecting CD 60-27 profiles lengthwise.

Material: Galvanised steel
Material thickness (mm): 0,6 mm

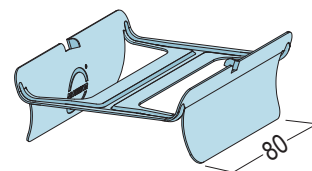

Item number	Description	Length (cm)	Order number	Width (mm)	Weight (kg/m/pc)	Package/ Large pack
6079	for C 60-27	8	110789		0,030	100 PC / 45 BOX

Angle connector flat

For longitudinal axial connection of CD 60/27 profiles in angles of 45° to 180°

Material: Galvanised steel
Material thickness (mm): 0,5 mm

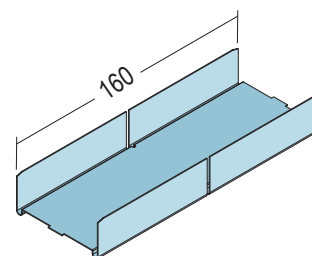

Item number	Description	Order number	Width (mm)	Weight (kg/m/pc)	Package/ Large pack
6077	for C 60-27	119032		0,072	100 PC / 24 BOX

CD safety cross connector

For connecting CD profiles on ceiling sub-structures.

Material: Galvanised steel
Material thickness (mm): 0,8 mm
Norm: EN 13964:2014
Norm: DIN18168-2
Load carrying class: 0,40 kN/Paar

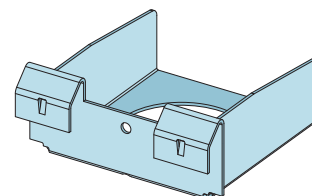

Item number	Description	Order number	Width (mm)	Weight (kg/m/pc)	Package/ Large pack
6116	for C 60-27	107925		0,055	100 PC / 45 BOX

U-hanger flat, for C 60-27

For mounting CD profiles on ceiling sub-structures

Material: Galvanised steel
Material thickness (mm): 0,9 mm
Norm: EN 13964:2014
Norm: DIN18168-2
Load carrying class: 0,40 kN

Item number	Description	Order number	Width (mm)	Weight (kg/m/pc)	Package/ Large pack
6169	65 mm	110127		0,033	100 PC / 280 BOX
6167	125 mm	110126		0,058	100 PC / 136 BOX
6159	200 mm	106313		0,080	100 PC / 66 BOX

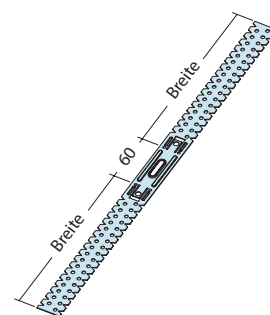

U-hanger flat for wood frame

For attaching frame wood on hanging ceiling sub-structures.

Material: Galvanised steel
Material thickness (mm): 0,9 mm
Norm: EN 13964:2014
Norm: DIN18168-2
Load carrying class: 0,40 kN

Item number	Description	Order number	Width (mm)	Weight (kg/m/pc)	Package/ Large pack
6166	125 mm	114050		0,057	100 PC / 136 BOX

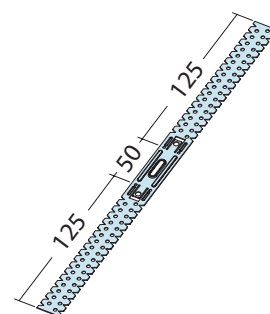

STANDARD ACCESSOIRES

PRODUCT CLASS 6500

U-hanger bent for CD 60-27

For attaching CD profiles on hanging ceiling sub-structures.

Material: Galvanised steel
Material thickness (mm): 0,9 mm
Norm: EN 13964:2014
Norm: DIN18168-2
Load carrying class: 0,40 kN

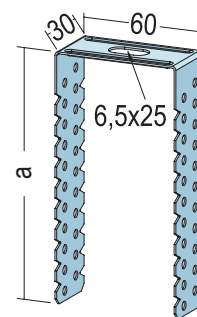

Item number	Description	Order number	Width (mm)	Weight (kg/m/pc)	Package/ Large pack
6161	65 mm	111371		0,032	100 PC / 45 BOX
6157	125 mm	107906		0,058	100 PC / 45 BOX

Quick install clip

For directly attaching CD profiles on hanging sub-constructions.

Material: Galvanised steel
Material thickness (mm): 1 mm
Norm: EN 13964:2014
Norm: DIN18168-2
Load carrying class: 0,40 kN

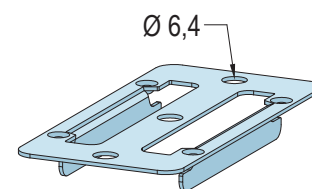

Item number	Description	Order number	Width (mm)	Weight (kg/m/pc)	Package/ Large pack
6092	for CD 60-27	111373		0,031	100 PC / 120 BOX

Fixing clip

For directly attaching ceiling profiles to wooden substructures

Material: Galvanised steel
Material thickness (mm): 0,7 mm
Norm: EN 13964:2014
Norm: DIN18168-2
Load carrying class: 0,15 kN

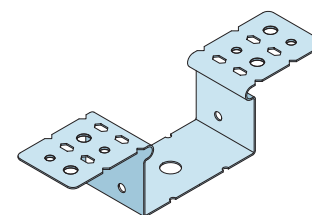

Item number	Description	Order number	Width (mm)	Weight (kg/m/pc)	Package/ Large pack
6128	for CD 60-27	118344		0,030	100 PC / 102 BOX

Direct hanging rail runner for direct mounting

For attaching CD profiles on hanging ceiling sub-structures.

Material: Galvanised steel
Material thickness (mm): 0,7 mm
Norm: EN 13964:2014
Norm: DIN18168-2
Load carrying class: 0,15 kN

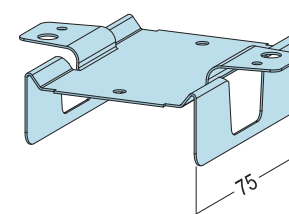

Item number	Description	Order number	Width (mm)	Weight (kg/m/pc)	Package/ Large pack
6096	for CD 60-28	112380		0,031	100 PC / 45 BOX

Adjustable direct hanging for C 60-27

For attaching CD profiles on hanging ceiling sub-structures. 2-pieces, includes safety clamps. Use washers for wooden beam screw joints.

Material: Galvanised steel
Material thickness (mm): 1 mm
Norm: EN 13964:2014
Norm: DIN18168-2
Load carrying class: 0,40 kN

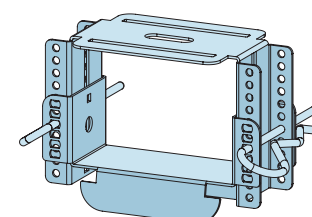

Item number	Description	Order number	Width (mm)	Weight (kg/m/pc)	Package/ Large pack
6111	40 - 70 mm	111475		0,130	50 PC / 66 BOX
6110	59 - 108 mm	107924		0,140	100 PC / 16 BOX

STANDARD ACCESSOIRES

PRODUCT CLASS 6500

Hanger for ceiling profile 60-27

For attaching CD profiles on hanging ceiling sub-constructions, especially onto wooden beams.

Material: Galvanised steel
Norm: EN 13964:2014
Norm: DIN18168-2
Load carrying class: 0,25 kN

Item number	Description	Order number	Width (mm)	Weight (kg/m/pc)	Package/ Large pack
6117	170 mm	106028		0,038	100 PC / 144 BOX
6118	270 mm	106029		0,060	100 PC / 84 BOX

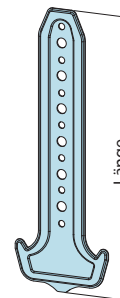

Anchor hanger with tension spring

For attaching CD profiles on ceiling sub-constructions with wire support.

Material: Galvanised steel
Material thickness (mm): 1 mm
Norm: EN 13964:2014
Norm: DIN18168-2
Load carrying class: 0,25 kN

Item number	Description	Order number	Width (mm)	Weight (kg/m/pc)	Package/ Large pack
6034	for C 60-27	101129		0,043	100 PC / 80 BOX

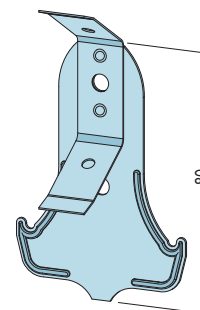

CD hanger

For mounting CD profiles on ceiling sub-constructions with wire support. Quick assembly facilitated by lateral wire insertion.

Material: Galvanised steel
Material thickness (mm): 1 mm
Norm: EN 13964:2014
Norm: DIN18168-2
Load carrying class: 0,40 kN

Item number	Description	Order number	Width (mm)	Weight (kg/m/pc)	Package/ Large pack
6038	for C 60-27	107902		0,059	100 PC / 45 BOX

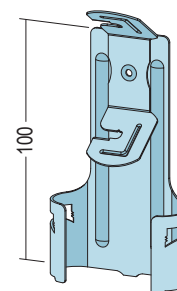

Tension spring with suspension wire

For mounting ceiling sub-constructions.

Material: Steel wire, galvanized / Spring steel
Norm: EN 13964:2014
Norm: DIN18168-2
Load carrying class: 0,25 kN

Item number	Description	Order number	Width (mm)	Weight (kg/m/pc)	Package/ Large pack
6009	100mm	101045		0,018	100 PC / 60 BOX
6008	200mm	101028		0,033	100 PC / 96 BOX

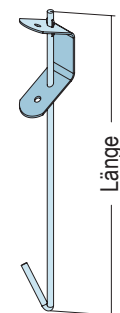

Quick install hanger hook/eye

For mounting ceiling sub-constructions.

Material: Steel wire, galvanized / Spring steel
Norm: EN 13964:2014
Norm: DIN18168-2
Load carrying class: 0,15 kN

Item number	Description	Order number	Width (mm)	Weight (kg/m/pc)	Package/ Large pack
6300	100 - 300 mm	111355		0,048	100 PC / 30 BOX
6301	300 - 600 mm	111356		0,077	100 PC / 24 BOX
6302	600 - 1000 mm	111357		0,114	100 PC / 20 BOX



STANDARD ACCESSOIRES

PRODUCT CLASS 6500

Double spring with special spring

For extending hooks/eyelet wires on ceiling sub- constructions. Quick assembly facilitated by lateral wire insertion.

Material: Spring steel, galvanized
Material thickness (mm): 0,75 mm
Norm: EN 13964:2014
Norm: DIN18168-2
Load carrying class: 0,40 kN



Item number	Description	Order number	Width (mm)	Weight (kg/m/pc)	Package/ Large pack
6004		115797		0,022	100 PC / 120 BOX

Suspension wire with hook

Application area: ceiling sub- constructions connected to suspension hangers.

Material: Steel wire, galvanised
Material thickness (mm): 4 mm
Norm: EN 13964:2014
Norm: DIN18168-1



Item number	Description	Order number	Width (mm)	Weight (kg/m/pc)	Package/ Large pack
6051	125 mm	101160		0,014	100 PC / 200 BOX
6052	250 mm	101162		0,027	100 PC / 200 BOX
6053	375 mm	101165		0,039	100 PC / 150 BOX
6054	500 mm	101166		0,051	100 PC / 100 BUN
6055	750 mm	101167		0,074	100 PC / 50 BUN
6056	1000 mm	101168		0,097	100 PC / 50 BUN

Suspension wire with eye

Application area: ceiling sub- constructions connected to suspension hangers.
 Eyelet Ø 6 mm

Material: Steel wire, galvanised
Material thickness (mm): 4 mm
Norm: DIN18168-1
Norm: EN 13964:2014



Item number	Description	Order number	Width (mm)	Weight (kg/m/pc)	Package/ Large pack
6041	125 mm	101137		0,014	100 PC / 200 BOX
6042	250 mm	101144		0,027	100 PC / 200 BOX
6043	375 mm	101145		0,039	100 PC / 150 BOX
6044	500 mm	101147		0,051	100 PC / 100 BUN
6045	750 mm	101148		0,074	100 PC / 50 BUN
6046	1000 mm	101151		0,097	100 PC / 50 BUN
6048	1250 mm	101155		0,118	100 PC / 50 BUN
6050	1500 mm	101157		0,148	100 PC / 50 BUN
6040	2000 mm	107871		0,194	100 PC / 50 BUN
6062	2500 mm	111346		0,244	100 PC / 50 BOX
6063	3000 mm	111347		0,294	100 PC / 50 BOX

STANDARD ACCESSOIRES

PRODUCT CLASS 6500

Adjusting strip for Nonius hanger

For mounting ceiling sub-constructions connected with vernier subdividers.

Material: Galvanised steel
Material thickness (mm): 1 mm
Norm: EN 13964:2014
Norm: DIN18168-2

Item number	Description	Order number	Width (mm)	Weight (kg/m/pc)	Package/ Large pack
6020	working length 85 mm	101099		0,021	100 PC / 100 BOX
6021	working length 135 mm	101101		0,035	100 PC / 100 BOX
6022	working length 235 mm	101104		0,056	100 PC / 84 BOX
6023	working length 340 mm	101106		0,075	100 PC / 56 BOX
6024	working length 440 mm	101110		0,090	100 PC / 40 BOX
6025	working length 540 mm	101111		0,105	100 PC / 40 BOX
6026	working length 640 mm	101112		0,126	100 PC / 32 BOX
6027	working length 740 mm	101114		0,150	100 PC / 32 BOX
6028	working length 840 mm	101116		0,165	100 PC / 24 BOX
6029	working length 940 mm	101117		0,175	100 PC / 24 BOX

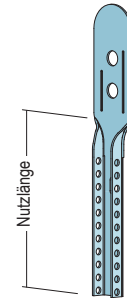

Adjusting strip for Nonius hanger

For mounting ceiling sub-constructions connected with vernier subdividers.

Material: Galvanised steel
Material thickness (mm): 1 mm
Norm: EN 13964:2014
Norm: DIN18168-2
DIN test standard: DIN 18168-2

Item number	Description	Order number	Width (mm)	Weight (kg/m/pc)	Package/ Large pack
60211	working length 1040 mm	111348		0,195	50 PC / 40 BUN
60212	working length 1140 mm	110165		0,212	50 PC / 40 BUN
60213	working length 1240 mm	111350		0,227	50 PC / 40 BUN
60214	working length 1340 mm	110166		0,243	50 PC / 40 BUN
60215	working length 1440 mm	111351		0,260	50 PC / 40 BUN
60216	working length 1540 mm	110167		0,277	50 PC / 32 BUN
6019	working length 1640 mm	101096		0,310	50 PC / 32 BUN
60218	working length 1740 mm	111352		0,327	50 PC / 32 BUN
60219	working length 1840 mm	111353		0,335	50 PC / 32 BUN
60220	working length 1940 mm	110162		0,345	50 PC / 32 BUN
60225	working length 2440 mm	110163		0,429	50 PC / 24 BOX
60230	working length 2940 mm	110164		0,513	50 PC / 20 BOX

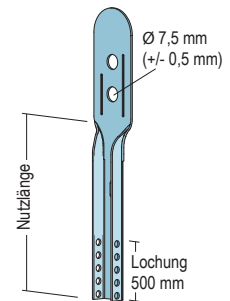

Nonius bar

For mounting onto ceiling sub-constructions to extend vernier suspensions.

Material: Galvanised steel
Material thickness (mm): 1 mm
Norm: EN 13964:2014
Norm: DIN18168-2

Item number	Description	Length (cm)	Order number	Width (mm)	Weight (kg/m/pc)	Package/ Large pack
6031		300	109824		0,174	20 PC / 15 BUN

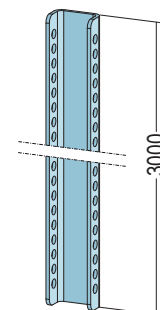

STANDARD ACCESSOIRES

PRODUCT CLASS 6500

Nonius connector

For mounting onto ceiling sub-constructs to extend vernier suspensions.

Material: Galvanised steel
Material thickness (mm): 1 mm
Norm: EN 13964:2014
Norm: DIN18168-2

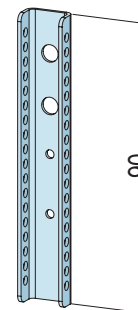

Item number	Description	Order number	Width (mm)	Weight (kg/m/pc)	Package/ Large pack
6032		111883		0,020	100 PC / 132 BOX

Fixing clip

Application area: ceiling substructures to create a connection between vernier shells and subdividers.
 Please apply 2 pieces per connection.

Material: Steel wire, galvanised
Material thickness (mm): 2,5 mm
Norm: EN 13964:2014
Norm: DIN18168-2

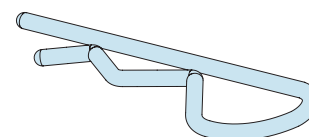

Item number	Description	Order number	Width (mm)	Weight (kg/m/pc)	Package/ Large pack
6199	for Nonius hanger	101525		0,006	100 PC / 600 BOX

Safety pin

Application area: ceiling substructures to create a connection between vernier shells and subdividers.
 Bend around fixing clip after installing.

Material: Steel wire, galvanised
Norm: EN 13964:2014
Norm: DIN18168-2

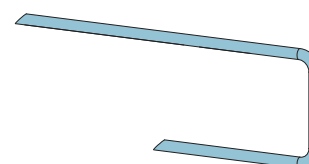

Item number	Description	Order number	Width (mm)	Weight (kg/m/pc)	Package/ Large pack
6201	for Nonius hanger	101532		0,005	100 PC / 300 BOX

Nonius hanger perforated

Application area: ceiling sub-constructs with vernier suspensions.

Material: Galvanised steel
Material thickness (mm): 1,2 mm
Norm: EN 13964:2014
Norm: DIN18168-2
Load carrying class: 0,40 kN

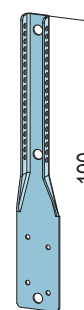

Item number	Description	Length (cm)	Order number	Width (mm)	Weight (kg/m/pc)	Package/ Large pack
6015	for hanging wood	19	101081		0,040	100 PC / 100 BOX

Nonius hanger angled

Application area: ceiling sub-constructs with vernier suspensions.

Material: Galvanised steel
Material thickness (mm): 1,2 mm
Norm: EN 13964:2014
Norm: DIN18168-2
Load carrying class: 0,40 kN

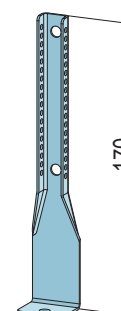

Item number	Description	Length (cm)	Order number	Width (mm)	Weight (kg/m/pc)	Package/ Large pack
6017	for wood hanging	17	101090		0,050	100 PC / 45 BOX

STANDARD ACCESSOIRES

PRODUCT CLASS 6500

Nonius hanger

For attaching CD profiles on ceiling sub-construct-ions with vernier suspensions.

Material: Galvanised steel
Material thickness (mm): 1,2 mm
Norm: EN 13964:2014
Norm: DIN18168-2
Load carrying class: 0,40 kN

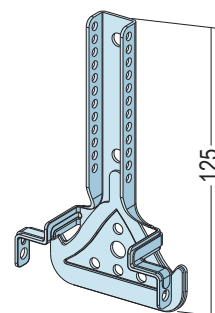

Item number	Description	Length (cm)	Order number	Width (mm)	Weight (kg/m/pc)	Package/ Large pack
6012	for C 60-27	12	101054		0,039	100 PC / 102 BOX

Nonius hanger

For attaching CD profiles on ceiling sub-construct-ions with vernier suspensions.

Material: Galvanised steel
Material thickness (mm): 1 mm
Norm: EN 13964:2014
Norm: DIN18168-2
Load carrying class: 0,40 kN

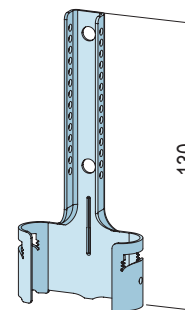

Item number	Description	Length (cm)	Order number	Width (mm)	Weight (kg/m/pc)	Package/ Large pack
6018	for C 60-27	13	107918		0,054	100 PC / 45 BOX

Nonius Hanger diagonal pull

For fastening ceiling profiles for substructures, dome and vault constructions. Variably adjustable for inclined suspensions. Lateral fastening possible due to rotary function.

Material: Galvanised steel
Material thickness (mm): 0,9 – 1,5 mm
Norm: EN 13964:2014
Norm: DIN18168-2
Load carrying class: 0,40 kN



Item number	Description	Length (cm)	Order number	Width (mm)	Weight (kg/m/pc)	Package/ Large pack
5547	for C 60-27	17	117398		0,065	100 PC / 32 BOX

Nonius hanger

For attaching CD profiles on ceiling sub-construct-ions with vernier suspensions, including fixing clip.

Material: Galvanised steel
Material thickness (mm): 1 mm
Norm: EN 13964:2014
Norm: DIN18168-2
Load carrying class: 0,40 kN

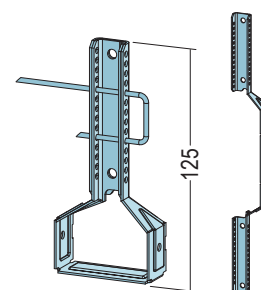

Item number	Description	Order number	Width (mm)	Weight (kg/m/pc)	Package/ Large pack
6014	für CD 60-27	101077		0,045	100 PC / 32 BOX

Nonius hanger

For attaching UA profiles on ceiling sub-construct-ions with vernier suspensions, including fixing clip.

Material: Galvanised steel
Material thickness (mm): 1 mm
Norm: EN 13964:2014
Norm: DIN18168-2
Load carrying class: 0,40 kN

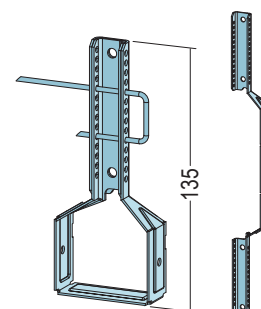

Item number	Description	Order number	Width (mm)	Weight (kg/m/pc)	Package/ Large pack
6013	for U-50-20	101070		0,045	100 PC / 32 BOX

STANDARD ACCESSOIRES

PRODUCT CLASS 6500

Connecting bracket

For attaching UA profiles to floors and ceilings.

Material: Galvanised steel
Material thickness (mm): 2 mm

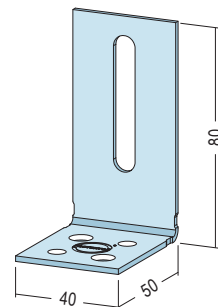

Item number	Description	Order number	Width (mm)	Weight (kg/m/pc)	Package/ Large pack
6185	for U 50	111884	40	0,070	100 PC / 60 BOX

Connecting bracket

For attaching UA profiles to floors and ceilings.

Material: Galvanised steel
Material thickness (mm): 2 mm
Load carrying class: k.A.

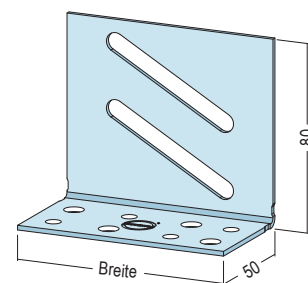

Item number	Description	Order number	Width (mm)	Weight (kg/m/pc)	Package/ Large pack
6183	for U 75 / U 100	110041	68	0,115	25 PC / 252 BUN
6182	for U 100/U 125	110040	93	0,234	25 PC / 168 BUN
6190	for U 125 / U 150	112401	118	0,234	25 PC / 168 BUN

Push fit bracket set for door post

For attaching UA/CW profiles to floors and ceilings. Includes:

- 4 x push-fit brackets
- 8 x pegs
- 8 x PVC guide rails for CW profiles

Material: Galvanised steel
Material thickness (mm): 2 mm

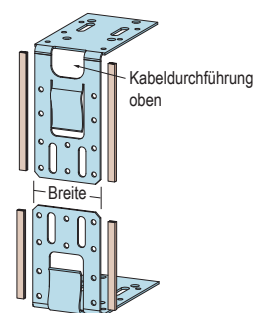

Item number	Description	Order number	Width (mm)	Weight (kg/m/pc)	Package/ Large pack
6751	for U/C 50	103740	47	0,740	1 PC / 500 BOX
6752	for U/C 75	103741	73	1,080	1 PC / 500 BOX
6753	for U/C 100	103742	97	1,440	1 PC / 500 BOX

Push fit bracket for door post

For attaching UA profiles to floor and ceiling.

Material: Galvanised steel

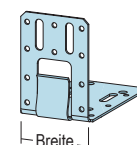

Item number	Description	Order number	Width (mm)	Weight (kg/m/pc)	Package/ Large pack
6754	for U 50	114741	47	0,185	50 PC / 20 BOX
6755	for U 75	114742	73	0,270	25 PC / 20 BOX
6756	for U 100	114743	97	0,360	25 PC / 20 BOX

Adjustable pivot bracket

For attaching CD profiles on wall facing.

Material: Galvanised steel
Material thickness (mm): 0,8 mm

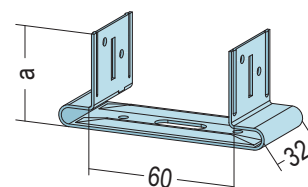

Item number	Description	Order number	Width (mm)	Weight (kg/m/pc)	Package/ Large pack
6156	30 mm	101419		0,034	100 PC / 55 BOX
6158	60 mm	106389		0,043	100 PC / 65 BOX

STANDARD ACCESSOIRES

PRODUCT CLASS 6500

flange clip

For attaching CD-60-27 profiles. Not suitable for mounting ceiling constructions.
For flange thickness ≥ 7 to ≤ 28 mm.

Material: Galvanised steel
Material thickness (mm): 0,6 mm

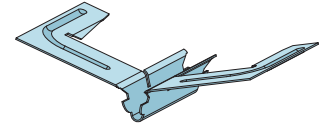

Item number	Description	Order number	Width (mm)	Weight (kg/m/pc)	Package/ Large pack
6141	for C 60-27	103372		0,024	100 PC / 45 BOX

Hanger

For attaching T rails on ceiling sub-constructions with wire support. Quick installation with special spring for lateral wire entries.

Material: Galvanised steel
Material thickness (mm): 1,5 mm
Norm: EN 13964:2014
Norm: DIN18168-2
Load carrying class: 0,15 kN

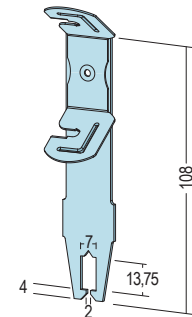

Item number	Description	Order number	Width (mm)	Weight (kg/m/pc)	Package/ Large pack
6162	for T-main profile	108001		0,034	100 PC / 72 BOX

SUBSTRUCTURE FLEXIBILO

PRODUCT CLASS 6590



SPECIAL PROFILES FOR CREATIVE DRYWALL CONSTRUCTION

Ceilings and walls are the most important design elements to shape the character of a room. Round and well-designed dry-wall constructions are in trend for shaping light and design installations. For special structures, radii, curves and connections, Protektor flexibilo offers a unique range of different special profiles.

With the concave or convex bendable ceiling profiles of the Protektor flexibilo series and the corresponding connection profiles, a wide variety of arch types, meandering ceilings, domes and freely designed shapes can be formed. The profiles can be bent directly on the construction site in all directions and in a dimensionally stable manner using simple means.

The flexibilo wall profiles are also individually formable and can be turned into round, elliptical and architecturally freely designed drywalls in just a few steps.



FORMABLE PROFILES FLEXIBILO

PRODUCT CLASS 6590

Concavely bendable C ceiling profile

Application area: for curved ceiling constructions.
Profiles must be bent on site.

Minimum bending radius 110 mm.
The specifications of the manufacturer of the boards must be observed

Material: Galvanised steel
Material thickness (mm): 0,6 mm
Norm: EN 14195:2005
Norm: EN 13964

Item number	Description	Length (cm)	Order number	Width (mm)	Weight (kg/m/pc)	Package/ Large pack
5550	C ceiling profile 60-27	300	117004	60	0,570	8 PCS / 24 BUN

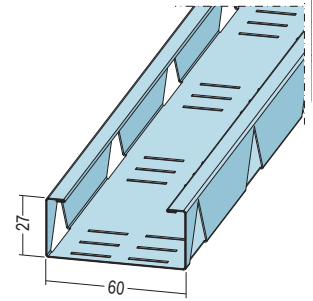

Convexely bendable C ceiling profile

Application area: for curved ceiling constructions.
Profiles must be bent on site.

Minimum bending radius 110 mm.
The specifications of the manufacturer of the boards must be observed.

Material: Galvanised steel
Material thickness (mm): 0,6 mm
Norm: EN 14195:2005
Norm: EN 13964

Item number	Description	Length (cm)	Order number	Width (mm)	Weight (kg/m/pc)	Package/ Large pack
5551	C ceiling profile 60-27	300	117005	60	0,570	8 PCS / 24 BUN

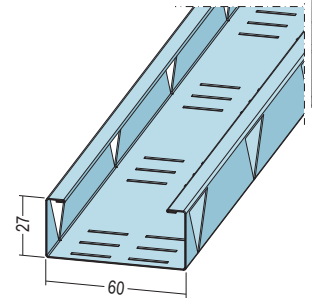

C Ceiling profile for concave and convex curves

Application area: for curved ceiling constructions.
Profiles must be bent on site.

Minimum bending radius 110 mm.
The specifications of the manufacturer of the boards must be observed

Material: Galvanised steel
Material thickness (mm): 0,6 mm
Norm: EN 14195:2005
Norm: EN 13964

Item number	Description	Length (cm)	Order number	Width (mm)	Weight (kg/m/pc)	Package/ Large pack
5549	C Ceiling profile 60-27	300	119500	60	0,533	8 PCS / 24 BUN

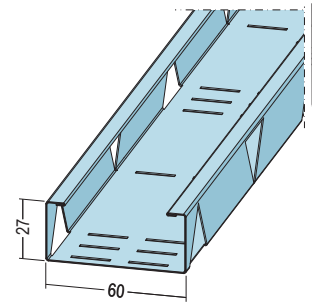

GR-connection profile pre-slotted

Application area: connection profile for vaulted ceilings as well as horizontal convex and concave connections to walls/columns.

Material: Galvanised steel
Material thickness (mm): 0,6 mm
Norm: EN 14195
Norm: DIN18182-1

Item number	Description	Length (cm)	Order number	Width (mm)	Weight (kg/m/pc)	Package/ Large pack
5241	U 28.5-27	300	108511	28,5	0,380	8 PCS / 24 BUN

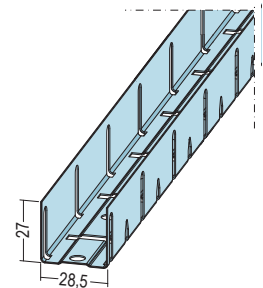

U connection profile bendable

Application area: for curved ceiling constructions.
Profiles must be bent on site.

Minimum bending radius 110 mm.
The specifications of the manufacturer of the boards must be observed.

Material: Galvanised steel
Material thickness (mm): 0,6 mm
Norm: EN 14195:2005
Norm: EN 13964

Item number	Description	Length (cm)	Order number	Width (mm)	Weight (kg/m/pc)	Package/ Large pack
5552	UD 28	300	116996	29,20	0,380	8 PCS / 25 BUN

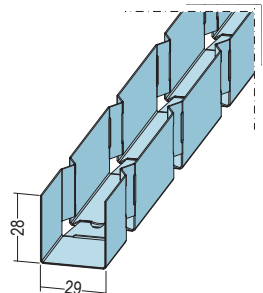

FORMABLE PROFILES FLEXIBILO

PRODUCT CLASS 6590

U track profile bendable

Application area: for curved wall constructions.
Profiles must be bent on site.

Minimum bending radius 200 mm.
The specifications of the manufacturer of the boards must be observed.

Material: Galvanised steel
Material thickness (mm): 0,6 mm
Norm: EN 14195:2005
Norm: EN 13964

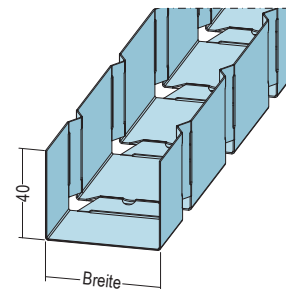

Item number	Description	Length (cm)	Order number	Width (mm)	Weight (kg/m/pc)	Package/ Large pack
5553	UW 50-06	300	117000	50	0,580	8 PCS / 25 BUN
5555	UW 75-06	300	117002	75	0,690	8 PCS / 20 BUN
5556	UW 100-06	300	117003	100	0,806	8 PCS / 15 BUN

RS/U-track pre-slotted

Application area: connection profile for round walls and angled connections.

Material: Galvanised steel
Material thickness (mm): 0,6 mm
Norm: EN 14195
Norm: DIN18182-1

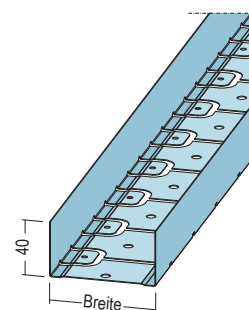

Item number	Description	Length (cm)	Order number	Width (mm)	Weight (kg/m/pc)	Package/ Large pack
5272	U 50-06	300	107822	50	0,530	8 PCS / 20 BUN
5273	U 75-06	300	107823	75	0,630	8 PCS / 15 BUN
5274	U 100-06	300	107824	100	0,740	8 PCS / 10 BUN

PROTEKTOR RS/U-TRACK PRE-SLOTTED ONE PROFILE FOR TWO APPLICATION AREAS

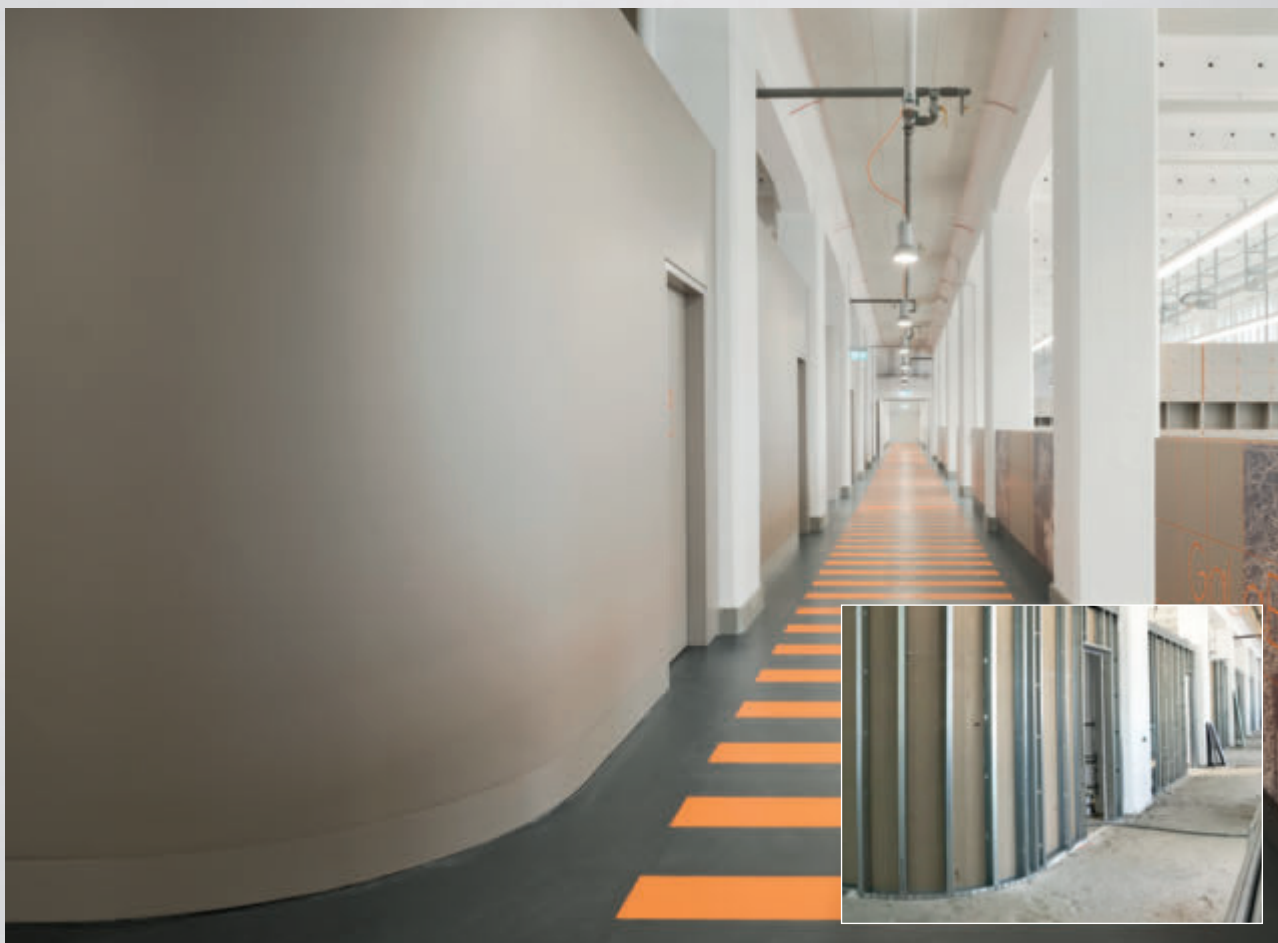

PROTEKTOR RS/U-TRACK PRE-SLOTTED – INNOVATIVE, PATENTED, DOES MORE



Time is money

With Protektor you do not waste your time either searching for the right product or fitting it. Our RS Profile can be used for a large variety of jobs in new and re-developments. It covers a number of different construction needs. The intelligent arrangement of prestamped shapes and perforations allows useful combinations and rapid fitting.

Hugely flexible

Special wall U-profile with a unique structure allowing two types of use:

- ▶ Rounded walls
- ▶ For slanted connections of partition walls and shaft walls

Amazing combinations

Cleverly designed perforations and pre-stamping allow sensible combination options. Makes work on new constructions, renovations, and reconstruction noticeably simpler.

Well thought-out designs

- ▶ A single product for multiple construction demands
- ▶ Easy to handle
- ▶ More flexibility
- ▶ Time saving
- ▶ Less storage space

PROTEKTOR RS-PROFIL – EIN PROFIL FÜR ZWEI ANWENDUNGSBEREICHE

Das innovative Protektor RS-Profil aus unserem Fachbuch kann mehr. Dank seiner einzigartigen Struktur ist das besonders leistungsfähige Profil in einer Kombinationen einsetzbar, sowohl bei Rund- als auch bei rechteckigen Verbindungen als auch bei Anschlüssen von Montageelementen oder Trennwänden an 90-Graden.

Ausblendeplatte für Schränke

U-Track für Rundwände

PROTEKTOR RS-PROFIL – EIN HILFREICHES PROBLEMLÖSER

Die besonderen Luchungen und Stanzungen des Protektor RS-Profiles lassen sinnvolle Kombinationen möglich sind durch natürliche Eigenschaften im Hinblick auf die Befestigung, Trennung, z. B.

- Für eine Vielzahl für mehrere Bauweise Anforderungen
- Flexibilität und Zeitersparnis
- einfache Handhabung
- weniger Lagerfläche

PROTEKTOR RS-PROFIL – EIN PROFIL IN MARKTSICHTE ABMESSUNGEN

Profil	Art. Nr.	Stärke	Material	Verpackung	Stückzahl	Verpackung
PROTEKTOR RS	1000	100	Alu	1000	1000	1000
PROTEKTOR RS	1000	100	Alu	1000	1000	1000
PROTEKTOR RS	1000	100	Alu	1000	1000	1000

Product video
View now »





INSTRUCTIONS FOR APPLICATION

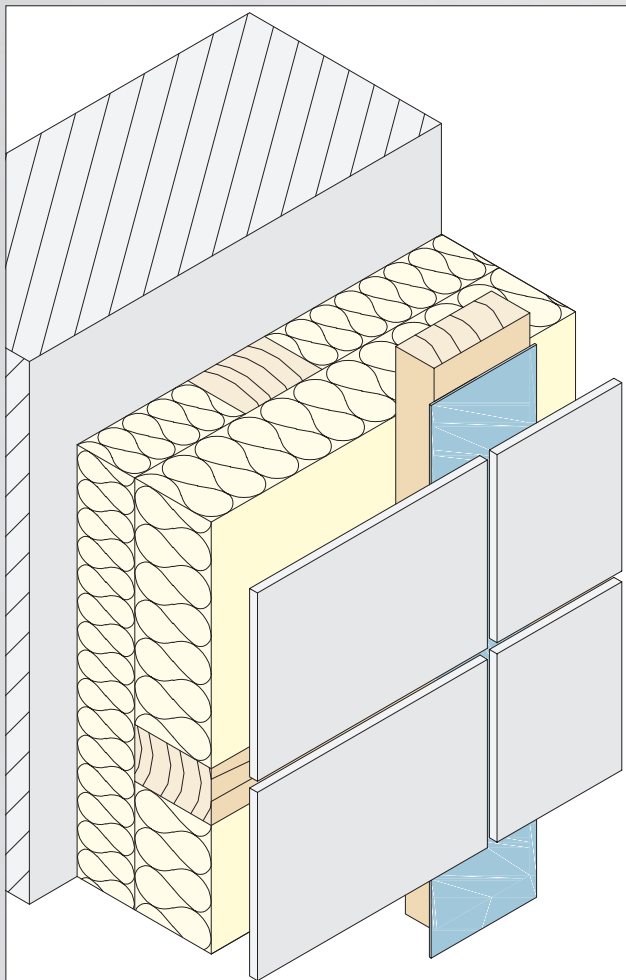

The joint tapes can be used for vertical joints and have different functions.

Joint tapes decouple the facade cladding and reduce noise transmission. They furthermore reduce water penetration and protect the substructure as well as the insulation from penetrating water.

For wooden substructures, the joint tape must overlap at least 5 mm on each side of the substructure.

PROTEKTOR joint tapes are made from aging-resistant and weather-resistant EPDM or soft PVC. The EPDM joint tapes significantly exceed the requirements of DIN 18516 Part 1 regarding temperature fluctuations and temperature limitations. Installation of the substructure is facilitated by the EPDM joint tapes with an adhesive foil, which is applied on site. Note: The adhesive foil increases the material thickness by approx. 0.2 mm.

PROTEKTOR recommends using joint tapes on wooden and aluminium substructures.

JOINT TAPES

PRODUCT CLASS 6650

Partition wall tape one-sided self-adhesive

Application area: connection sealing strips, self-gluing one side for ceiling constructions.
Building material class B2.

Material: Polyethylene
Material thickness (mm): 3 mm

Item number	Description	Length (cm)	Order number	Width (mm)	Weight (kg/m/pc)	Package/ Large pack
6197	30 mm	3	101522	30	0,008	30 ROL / 12 BOX
6194	45 mm	3	101511	45	0,011	20 ROL / 12 BOX
6195	70 mm	3	101516	70	0,016	12 ROL / 12 BOX
6196	95 mm	3	101520	95	0,020	10 ROL / 12 BOX



Mixed fibre fleece one-sided self-adhesive

Application area: connection sealing strips for self-gluing one side of dividing walls.
Building material class B3.

Material: Mixed fibre fleece
Material thickness (mm): 3 mm

Item number	Description	Length (cm)	Order number	Width (mm)	Weight (kg/m/pc)	Package/ Large pack
6187	50 x 3 mm	2	101506	50	0,022	6 ROL / 72 BOX
6188	70 x 3 mm	2	100125	70	0,035	4 ROL / 72 BOX
6189	95 x 3 mm	2	101509	95	0,045	3 ROL / 72 BOX



Joint tape with fold groove

With central groove and double perforations.
Ideally suited for as a reinforcing strip for covering joints on gypsum and gypsum fibreboards.

Material: paper
Norm: EN 13963:2005

Item number	Description	Length (cm)	Order number	Width (mm)	Weight (kg/m/pc)	Package/ Large pack
53110	50 mm	2	112163	50	0,040	20 ROL / 66 BOX
53111	50 mm	7	112165	50	0,500	20 ROL / 45 BOX



Edge protection aluzink

Perforated paper with metal strips;
Ideally suited for reinforcing the corners of walls, roof extensions and ceilings when executing drywall construction.
Variable in use for acute to obtuse-angled edges.

Material: Paper with metal strips
Norm: EN 14353

Item number	Description	Length (cm)	Order number	Width (mm)	Weight (kg/m/pc)	Package/ Large pack
53000	50 mm	3	112170	50,0	1,320	10 ROL / 42 BOX



Trennfix separation strips

With single-sided self-adhesive strips for separating construction elements and preventing the formation of tears along construction element connections.

Material: paper

Item number	Description	Length (cm)	Order number	Width (mm)	Weight (kg/m/pc)	Package/ Large pack
53400	65 mm	5	114231	65	0,350	24 ROL / 25 BOX





PRECISION CONNECTS

Here you will find everything you need for stable connections. Our precision and high quality fixing elements make for rapid and precise work. The product range includes self-drilling screws and dowels to provide secure attachments.

FIXING ACCESSORIES

PRODUCT CLASS 6600

Mounting set

For jointing connection angles with UA profiles and back-to-back screws on wide span supports.
Includes: Flathead screw with special 2mm-square neck
DIN 603/4.6 with U washers and nuts,
M8 x 20 mm.
Quality 4.6

Material: Galvanised steel

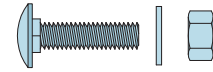

Item number	Description	Order number	Width (mm)	Weight (kg/m/pc)	Package/ Large pack
6203	M8 x 20 SW 13	101533		0,021	100 PC / 384 BOX

Mounting set

For connecting light steel components.
Includes: Hexagon head screws with combination nut.
M8 x 30 mm
Quality 8.8
Quality 8.8

Material: Galvanised steel

Norm: DIN EN ISO 4017

DIN test standard: DIN EN ISO 4032

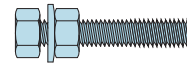

Item number	Description	Order number	Width (mm)	Weight (kg/m/pc)	Package/ Large pack
6202	M8 x 30 SW 13	114437		0,042	100 PC / 350 BOX

Dry wall screw with bit

Universal drywall screw FN with flat head, double thread and nail point. For hangers and profiles on wood/wood materials and thin-walled steel profiles.
incl. bit per box

Material: Steel, phosphated

Norm: EN 14566

Norm: DIN18182-2



Item number	Description	Order number	Width (mm)	Weight (kg/m/pc)	Package/ Large pack
6228	FN 4,2 x 35 mm	119453		1,900	500 PC / 288 BOX
6229	FN 4,2 x 65 mm	119349		3,200	500 PC / 96 BOX

Dry wall screw TN

Sheet metal screw with cross-head and self-drilling tip for sheet metal thicknesses between 0.7 and 2.25 mm.

Material: Steel, phosphated

Norm: EN 14566

Norm: DIN18182-2



Item number	Description	Order number	Width (mm)	Weight (kg/m/pc)	Package/ Large pack
6216	3.5 x 35 mm	112428		2,000	1000 PC / 288 BOX

Dry wall screw FN with flat head

Drywall screw FN with flat head for suspension on wooden components

Material: Steel, phosphated

Norm: EN 14566

Norm: DIN18182-2



Item number	Description	Order number	Width (mm)	Weight (kg/m/pc)	Package/ Large pack
6242	FN 4.2 x 35 mm	112447		0,611	200 PC / 600 BOX

FIXING ACCESSORIES

PRODUCT CLASS 6600

Ceiling dowel

Steel dowels for connecting drywall construction systems in concrete.

Material: Galvanised steel

European Technical Approval: ETA-14/0390

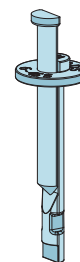

Item number	Description	Order number	Width (mm)	Weight (kg/m/pc)	Package/ Large pack
6260	6 x 40 mm	110628		0,015	100 PC / 300 BOX

Impact dowel

For installing UW profiles with a drilling diameter of 6 mm.
Max. mounting thickness of 12 mm.
Not suitable for suspended ceilings!

Material: Galvanised steel

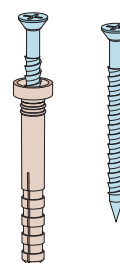

Item number	Description	Order number	Width (mm)	Weight (kg/m/pc)	Package/ Large pack
6248	6 x 40mm	101666		0,004	100 PC / 450 BOX

Sheet metal screw

Sheet metal screw with cross-head and screw tip for sheet metal thicknesses of up to 0.7 mm, with outside head diameter of 11 mm.

Material: Galvanised steel
Norm: EN 14566



Item number	Description	Order number	Width (mm)	Weight (kg/m/pc)	Package/ Large pack
6239	4,2 x 13 mm	112445		1,800	1000 PC / 384 BOX

Sheet metal screw with flat head

Sheet metal screw with cross-head and self-drilling tip for sheet metal thicknesses between 0.7 and 2.25 mm, with outside head diameter of 11 mm.

Material: Galvanised steel
Norm: EN 14566



Item number	Description	Order number	Width (mm)	Weight (kg/m/pc)	Package/ Large pack
6236	4,2 x 13 mm	112438		1,800	1000 PC / 384 BOX
6237	4,2 x 19 mm	112443		2,500	1000 PC / 388 BOX

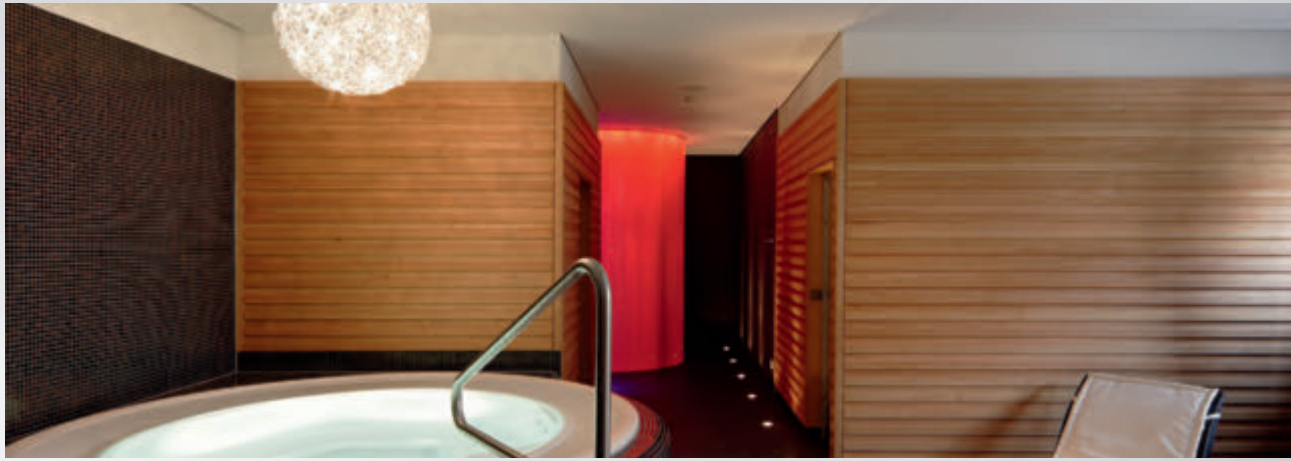

OVERVIEW OF CORROSION PROTECTION STANDARDS

Providing highly resistant protection against corrosion will guarantee that metal substructures for drywall remain durable for a long period of time. All PROTEKTOR metal substructures are protected against corrosion in line with the industry norms and provided complete protection under normal climatic conditions. When faced with higher demands, such as in exterior areas or swimming halls, additional coating is needed. Protektor offers profile systems to meet these needs, including accessories conform to EN ISO 12944.

In order to ensure the necessary degree of safety, additional corrosion protection coating is applied at the factory, in line with EN 13964. The quality of the special coatings has been tested and confirmed.



Corrosivity category and corrosion stress in accordance with EN ISO 12944-2	Examples for environments in line with EN ISO 12944-2 and EN ISO 9223		Suitable system by Protektor with protection duration	Tests	Coating
	outside	inside			
C3 moderate	Urban and industrial atmosphere with moderate level of air contaminants, coastal areas with low level of salt content.	Production areas with high level of moisture and some air contaminants, e.g. dairy plants, breweries, laundries, food production facilities.	Profiles: C3 - very high C4 - high C5 - medium Accessories and UA profiles: C3 - very high to C5 - high	Condensate test 720 h for all profiles and accessory components. Salt spray test 720 h for profiles. Additional salt spray test C5M 1,440 h for all accessory components and UA profiles.	CD/UD/CW and UW are coil coated. UA profiles and accessory components are powder coated.
C4 strong	Industrial areas, coastal areas with moderate levels of salt content.	Rooms subject to frequent condensation and high levels of air contaminants caused by production processes, e.g. industrial facilities and swimming halls. Damp rooms, e.g. shower areas, chemical facilities, boat houses located over sea water.	Profiles: C4 - high C5 - medium Accessories and UA profiles: C3 - very high to C5 - high	Condensate test 720 h for all profiles and accessory components. Salt spray test 720 h for profiles. Additional salt spray test C5M 1,440 h for all accessory components and UA profiles.	CD/UD/CW and UW are coil coated. UA profiles and accessory components are powder coated.
C5 very strong	Coastal and off-shore areas with high levels of salt content. When sealed corners are indicated in the tender specifications.	Buildings and areas subject to nearly constant condensation and with high levels of contaminants, e.g. saltwater baths and thermal baths. When sealed corners are indicated in the tender specifications.	Profiles: C5 - high Accessories and UA profiles: C3 - very high to C5 - high	Condensate test 720 h and salt spray test C5M 1,440 h for all accessory components and profiles.	UA profiles and accessory components are powder coated.

Please observe the respective tender specifications when choosing a suitable system.

ANTI CORROSION DEFENDO

PRODUCT CLASS 6570

Ceiling profile round return C3 very high|C4 high|C5 middle

Application area: hanging ceilings and wall facings with increased corrosion resistance requirements.

Material: Galvanised steel with coating
Material thickness (mm): 0,6 mm
Norm: EN 14195
Norm: DIN18182-1
DIN test standard: DIN 18168-2
Notes:
 Similar to RAL 9005

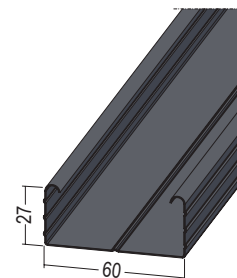

Item number	Description	Length (cm)	Order number	Width (mm)	Weight (kg/m/pc)	Package/ Large pack
58102	C 60-27	400	112237	60	0,575	12 PCS / 15 BUN

U-connection profile C3 very high|C4 high|C5 middle

Application area: connection profile for hanging ceilings and wall facings with increased corrosion resistance requirements.

Material: Galvanised steel with coating
Material thickness (mm): 0,6 mm
Norm: EN 14195
Norm: DIN18182-1
Notes:
 Similar to RAL 9005

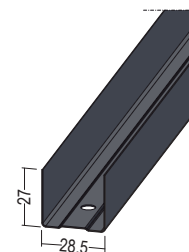

Item number	Description	Length (cm)	Order number	Width (mm)	Weight (kg/m/pc)	Package/ Large pack
58122	UD 28-27	300	109447	28,5	0,370	16 PCS / 28 BUN

U-connection profile C3 very high|C4 high|C5 middle

Application area: connection profile for hanging ceilings and wall facings with increased corrosion resistance requirements.

Material: Galvanised steel with coating
Material thickness (mm): 0,6 mm
Norm: EN 14195
Norm: DIN18182-1
Notes:
 Similar to RAL 9005

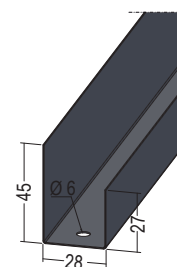

Item number	Description	Length (cm)	Order number	Width (mm)	Weight (kg/m/pc)	Package/ Large pack
58168	U 28-45/27	300	110274	28	0,471	16 PCS / 20 BUN

Hat ceiling profile C3 very high|C4 high|C5 middle

Application area: ceilings and wall facings with increased corrosion resistance requirements.

Material: Galvanised steel with coating
Material thickness (mm): 0,6 mm
Norm: EN 14195
Norm: DIN18182-1
Notes:
 Similar to RAL 9005

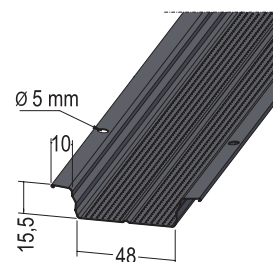

Item number	Description	Length (cm)	Order number	Width (mm)	Weight (kg/m/pc)	Package/ Large pack
59014	48-15.5	400	108912	48	0,473	10 PCS / 20 BUN

ANTI CORROSION DEFENDO

PRODUCT CLASS 6570

C-stud C3 very high|C4 high|C5 middle

Application area: stand profile for walls/wall faces or support profile for free-spanning ceilings with increased corrosion resistance requirements.
H cut-out at each end, continuously every 250 mm and subsequently every 500 mm.

Material: Galvanised steel with coating
Material thickness (mm): 0,6 mm
Norm: EN 14195
Norm: DIN18182-1
Notes:
Similar to RAL 9005
Special lengths on request

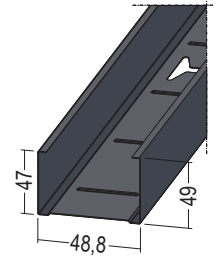

Item number	Description	Length (cm)	Order number	Width (mm)	Weight (kg/m/pc)	Package/ Large pack
59011	C 50-06	300	110069	48,8	0,706	8 PCS / 16 BUN
	C 50-06	350	110502	48,8	0,706	8 PCS / 16 BUN
	C 50-06	400	110070	48,8	0,690	8 PCS / 16 BUN
	C 50-06	450	110503	48,8	0,706	8 PCS / 16 BUN

C-stud C3 very high|C4 high|C5 middle

Application area: stand profile for walls/wall faces or support profile for free-spanning ceilings with increased corrosion resistance requirements.
H cut-out at each end, continuously every 250 mm and subsequently every 500 mm.

Material: Galvanised steel with coating
Material thickness (mm): 0,6 mm
Norm: EN 14195
Norm: DIN18182-1
Notes:
Similar to RAL 9005

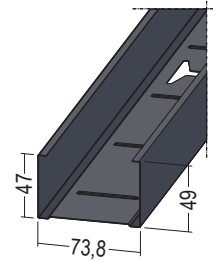

Special lengths on request

Item number	Description	Length (cm)	Order number	Width (mm)	Weight (kg/m/pc)	Package/ Large pack
59015	C 75-06	300	110071	73,8	0,830	8 PCS / 12 BUN
	C 75-06	350	110504	73,8	0,820	8 PCS / 12 BUN
	C 75-06	400	110073	73,8	0,830	8 PCS / 12 BUN
	C 75-06	450	110505	73,8	0,820	8 PCS / 12 BUN
	C 75-06	500	118082	73,8	0,820	8 PCS / 12 BUN

C-stud C3 very high|C4 high|C5 middle

Application area: stand profile for walls/wall faces or support profile for free-spanning ceilings with increased corrosion resistance requirements.
H cut-out at each end, continuously every 250 mm and subsequently every 500 mm.

Material: Galvanised steel with coating
Material thickness (mm): 0,6 mm
Norm: EN 14195
Norm: DIN18182-1
Notes:
Special lengths on request

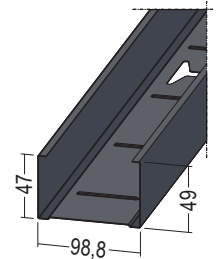

Similar to RAL 9005

Item number	Description	Length (cm)	Order number	Width (mm)	Weight (kg/m/pc)	Package/ Large pack
59016	C 100-06	260	115736	98,8	0,950	8 PCS / 8 BUN
	C 100-06	300	110074	98,8	0,950	8 PCS / 8 BUN
	C 100-06	350	110506	98,8	0,929	8 PCS / 8 BUN
	C 100-06	400	110076	98,8	0,950	8 PCS / 8 BUN
	C 100-06	450	110507	98,8	0,929	8 PCS / 8 BUN
	C 100-06	500	115982	98,8	0,929	8 PCS / 8 BUN

ANTI CORROSION DEFENDO

PRODUCT CLASS 6570

C-stud C3 very high|C4 high|C5 middle

Application area: stand profile for walls/wall faces or support profile for free-spanning ceilings with increased corrosion resistance requirements.
H cut-out at each end, continuously every 250 mm and subsequently every 500 mm.

Material: Galvanised steel with coating
Material thickness (mm): 0,6 mm
Norm: EN 14195
Norm: DIN18182-1
Notes:
Special lengths on request

Similar to RAL 9005

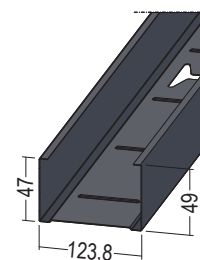

Item number	Description	Length (cm)	Order number	Width (mm)	Weight (kg/m/pc)	Package/ Large pack
59041	C 125-06	400	110436	123,8	1,067	8 PCS / 8 BUN

C-stud C3 very high|C4 high|C5 middle

Application area: stand profile for walls/wall faces or support profile for free-spanning ceilings with increased corrosion resistance requirements.
H cut-out at each end, continuously every 250 mm and subsequently every 500 mm.

Material: Galvanised steel with coating
Material thickness (mm): 0,6 mm
Norm: EN 14195
Norm: DIN18182-1
Notes:
Special lengths on request

Similar to RAL 9005

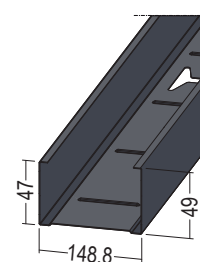

Item number	Description	Length (cm)	Order number	Width (mm)	Weight (kg/m/pc)	Package/ Large pack
59024	C 150-06	400	110651	148,8	1,161	4 PCS / 12 BUN

U-track C3 very high|C4 high|C5 middle

Application area: supporting bracket for walls/wall faces or for free-spanning ceilings with increased corrosion resistance requirements.

Material: Galvanised steel with coating
Material thickness (mm): 0,6 mm
Norm: EN 14195
Norm: DIN18182-1
Notes:
Similar to RAL 9005

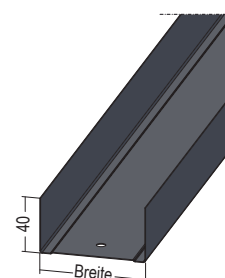

Item number	Description	Length (cm)	Order number	Width (mm)	Weight (kg/m/pc)	Package/ Large pack
59030	U 50-06	400	108079	50	0,580	8 PCS / 20 BUN
59033	U 75-06	400	108080	75	0,690	8 PCS / 15 BUN
59034	U 100-06	400	108081	100	0,806	8 PCS / 10 BUN
59048	U 125-06	400	110430	125	0,917	4 PCS / 15 BUN
59047	U 150-06	400	108122	150	0,980	4 PCS / 15 BUN

Ceiling profile round return C4 very high|C5 high

Application area: hanging ceilings and wall facings with increased corrosion resistance requirements.

Material: Galvanised steel with coating
Material thickness (mm): 0,6 mm
Norm: EN 14195
Norm: DIN18182-1
Norm: EN 13964
Notes:
Similar to RAL 7016

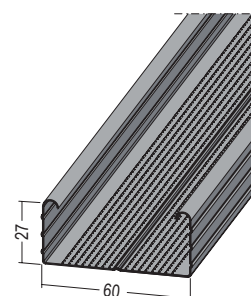

Item number	Description	Length (cm)	Order number	Width (mm)	Weight (kg/m/pc)	Package/ Large pack
58130	C 60-27	400	110068	60	0,575	12 PCS / 15 BUN

ANTI CORROSION DEFENDO

PRODUCT CLASS 6570

U-connection profile C4 very high|C5 high

Application area: connection profile for hanging ceilings and wall facings with increased corrosion resistance requirements.

Material: Galvanised steel with coating
Material thickness (mm): 0,6 mm
Norm: EN 14195
Norm: DIN18182-1
Notes:
 Similar to RAL 7016

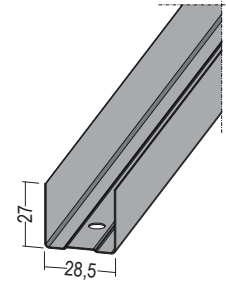

Item number	Description	Length (cm)	Order number	Width (mm)	Weight (kg/m/pc)	Package/ Large pack
58148	U 28-27	300	109485	28,5	0,370	16 PCS / 28 BUN

C-stud MAXI C4 very high|C5 high

Application area: stand profile for walls/wall faces or support profile for free-spanning ceilings with increased corrosion resistance requirements.
 H cut-out at each end, continuously every 250 mm and subsequently every 500 mm.

Material: Galvanised steel with coating
Material thickness (mm): 0,6 mm
Norm: EN 14195
Norm: DIN18182-1
Notes:
 Similar to RAL 7016

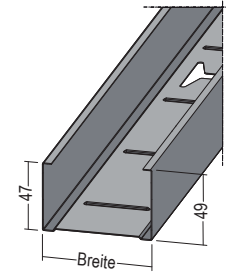

Item number	Description	Length (cm)	Order number	Width (mm)	Weight (kg/m/pc)	Package/ Large pack
59211	C 50-06	300	110083	48,8	0,706	8 PCS / 16 BUN
	C 50-06	400	110084	48,8	0,706	8 PCS / 16 BUN
59215	C 75-06	300	110085	73,8	0,820	8 PCS / 12 BUN
	C 75-06	400	110086	73,8	0,820	8 PCS / 12 BUN
59216	C 100-06	300	110087	98,8	0,929	8 PCS / 8 BUN
	C 100-06	400	110088	98,8	0,929	8 PCS / 8 BUN

U-Wall profile UW C4 very high|C5 high

Application area: supporting bracket for walls/wall faces or for free-spanning ceilings with increased corrosion resistance requirements.

Material: Galvanised steel with coating
Material thickness (mm): 0,6 mm
Norm: EN 14195
Norm: DIN18182-1
Notes:
 Similar to RAL 7016

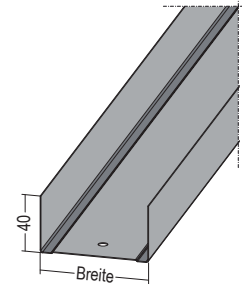

Item number	Description	Length (cm)	Order number	Width (mm)	Weight (kg/m/pc)	Package/ Large pack
59230	U 50	400	109688	50	0,580	8 PCS / 20 BUN
59233	U 75	400	109689	75	0,690	8 PCS / 15 BUN
59234	U 100	400	109690	100	0,806	8 PCS / 10 BUN

U-reinforcing profile UA C3-C5 universal

Application area: walls/wall faces, especially in door areas, or support profiles for free-spanning ceilings with increased corrosion resistance requirements.

Material: Galvanised steel with coating
Material thickness (mm): 2 mm
Norm: EN 14195
Norm: DIN18182-1
Notes:
 Similar to RAL 7016

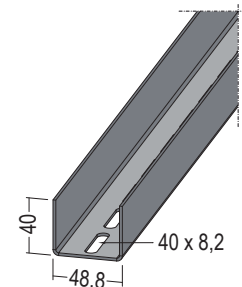

Item number	Description	Length (cm)	Order number	Width (mm)	Weight (kg/m/pc)	Package/ Large pack
59019	U 50-20	300	110077	48,8	1,770	6 PCS / 15 BUN
	U 50-20	350	110508	48,8	1,770	6 PCS / 15 BUN
	U 50-20	400	110078	48,8	1,770	6 PCS / 15 BUN
	U 50-20	450	110509	48,8	1,770	6 PCS / 15 BUN
	U 50-20	500	114734	48,8	1,770	6 PCS / 15 BUN

ANTI CORROSION DEFENDO

PRODUCT CLASS 6570

U-reinforcing profile UA C3-C5 universal

Application area: walls/wall faces, especially in door areas, or support profiles for free-spanning ceilings with increased corrosion resistance requirements.

Material: Galvanised steel with coating
Material thickness (mm): 2 mm
Norm: EN 14195
Norm: DIN18182-1
Notes:
 Similar to RAL 7016

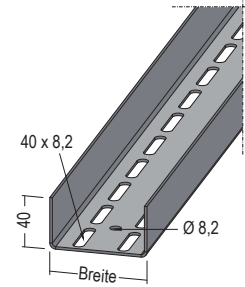

Item number	Description	Length (cm)	Order number	Width (mm)	Weight (kg/m/pc)	Package/ Large pack
59020	U 75-20	300	110079	73.8	1,990	4 PCS / 25 BUN
	U 75-20	350	110510	73.8	1,990	4 PCS / 25 BUN
	U 75-20	400	110080	73.8	1,990	4 PCS / 25 BUN
	U 75-20	450	110511	73.8	1,990	4 PCS / 25 BUN
	U 75-20	500	114735	73.8	1,990	4 PCS / 25 BUN
59021	U 100-20	300	109679	98.8	2,485	4 PCS / 15 BUN
	U 100-20	350	110512	98.8	2,485	4 PCS / 15 BUN
	U 100-20	400	109680	98.8	2,485	4 PCS / 15 BUN
	U 100-20	450	110513	98.8	2,485	4 PCS / 15 BUN
	U 100-20	500	114736	98.8	2,485	4 PCS / 15 BUN
59022	U 125-20	400	110428	123.8	3,065	2 PCS / 30 BUN
59023	U 150-20	400	115813	148.8	3,678	2 PCS / 24 BUN
	U 150-20	600	115814	148.8	3,678	2 PCS / 24 BUN

CD quick cross brace C3-C5 high

For creating cross connections for CD profiles on hanging ceiling sub-constructions with increased corrosion resistance requirements.

Material: Galvanised steel with coating
Material thickness (mm): 0,8 mm
Norm: EN 13964:2014
Norm: DIN18168-2
Load carrying class: 0,40 kN
Notes:
 Similar to RAL 7016

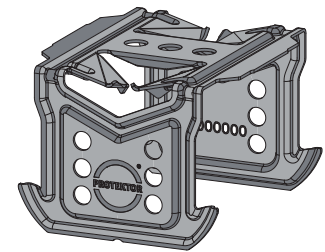

Item number	Description	Order number	Width (mm)	Weight (kg/m/pc)	Package/ Large pack
58104	for C 60-27	109449		0,040	100 PC / 45 BOX

CD-quick cross brace flat C3-C5 high

For creating cross connections from UA-50 to CD 60-27 profiles on hanging ceiling sub-constructions with increased corrosion resistance requirements.

Material: Galvanised steel with coating
Material thickness (mm): 0,9 mm
Norm: EN 13964:2014
Norm: DIN18168-2
Load carrying class: 0,40 kN
Notes:
 Similar to RAL 7016

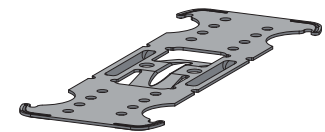

Item number	Description	Order number	Width (mm)	Weight (kg/m/pc)	Package/ Large pack
58304	for U 50 to C 60-27	110179		0,042	100 PC / 45 BOX

C-ceiling profile connector C3-C5 high

For laterally connecting CD 60-27 profiles with increased corrosion resistance requirements.

Material: Galvanised steel with coating
Material thickness (mm): 0,5 mm
Norm: EN 13964:2014
Notes:
 Similar to RAL 7016

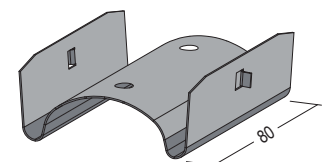

Item number	Description	Length (cm)	Order number	Width (mm)	Weight (kg/m/pc)	Package/ Large pack
58103	for C 60-27	8	109448		0,043	100 PC / 45 BOX

ANTI CORROSION DEFENDO

PRODUCT CLASS 6570

U-hanger flat C3-C5 high

For attaching CD profiles on hanging ceiling sub-constructions with increased corrosion resistance requirements.

Material: Galvanised steel, with C3-C5-surface coating

Material thickness (mm): 0,9 mm

Norm: EN 13964:2014

Norm: DIN18168-2

Load carrying class: 0,40 kN

Notes:

Similar to RAL 7016

Item number	Description	Order number	Width (mm)	Weight (kg/m/pc)	Package/ Large pack
58159	200 mm	115165		0,080	100 PC / 66 BOX

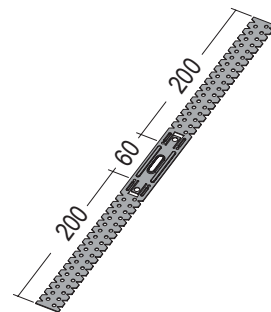

U-hanger C3-C5 pre-bent high

For attaching CD profiles on hanging ceiling sub-constructions with increased corrosion resistance requirements.

Material: Galvanised steel with coating

Material thickness (mm): 0,9 mm

Norm: EN 13964:2014

Norm: DIN18168-2

Load carrying class: 0,40 kN

Notes:

Similar to RAL 7016

Item number	Description	Order number	Width (mm)	Weight (kg/m/pc)	Package/ Large pack
58121	125 mm	109467		0,058	100 PC / 45 BOX

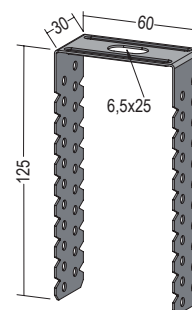

Nonius hanger C3-C5 high

For attaching CD profiles on ceiling sub-constructions with vernier suspensions increased corrosion resistance.

Material: Galvanised steel with coating

Material thickness (mm): 1,2 mm

Norm: EN 13964:2014

Norm: DIN18168-2

Load carrying class: 0,40 kN

Notes:

Similar to RAL 7016

Item number	Description	Length (cm)	Order number	Width (mm)	Weight (kg/m/pc)	Package/ Large pack
58108	for C 60-27	12	109452		0,048	100 PC / 51 BOX

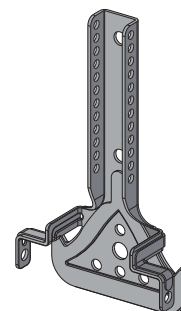

Adjustable direct hanging for CD 60-27 C3-C5 high

For attaching CD profiles on hanging ceiling sub-constructions with increased corrosion resistance requirements.

Suspension height up to CD profile sub-construction 59-108 mm.

2-pieces, includes safety clamps. Use washers for wooden beam screw joints.

Material: Galvanised steel with coating

Material thickness (mm): 1 mm

Norm: EN 13964:2014

Norm: DIN18168-2

Load carrying class: 0,40 kN

Notes: Bi

Notes:

Similar to RAL 7016

Item number	Description	Order number	Width (mm)	Weight (kg/m/pc)	Package/ Large pack
58310	59 - 108 mm	112300		0,130	100 PC / 16 BOX

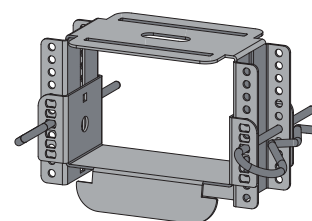

Click-Fix Track mounting C3-C5 high

For directly attaching CD profiles on hanging ceiling sub-constructions with increased corrosion resistance requirements.

Material: Galvanised steel with coating

Material thickness (mm): 1 mm

Norm: EN 13964:2014

Norm: DIN18168-2

Load carrying class: 0,40 kN

Notes:

Similar to RAL 7016

Item number	Description	Order number	Width (mm)	Weight (kg/m/pc)	Package/ Large pack
58128	for C 60-27	110704		0,028	100 PC / 102 BOX

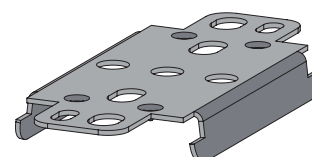

ANTI CORROSION DEFENDO

PRODUCT CLASS 6570

Nonius hanger for UA 50 C3-C5 high

For attaching UA profiles on ceiling sub-construct-
tions with vernier suspensions, without safety
bars, with increased corrosion resistance.

Material: Galvanised steel with coating

Material thickness (mm): 1 mm

Norm: EN 13964:2014

DIN test standard: DIN 18168-2

Load carrying class: 0,40

Notes:

Similar to RAL 7016

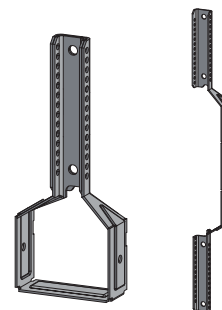

Item number	Description	Order number	Width (mm)	Weight (kg/m/pc)	Package/ Large pack
58129	without safety clip	110705		0,053	100 PC / 32 BOX

Fixing clip C3-C5 high

Application area: ceiling sub-construct-
ions as a connection between vernier shells and subdi-
viders, with increased corrosion resistance
requirements.

Please apply 2 pieces per connection.

Material: Steel wire, galvanised with coating

Material thickness (mm): 2,5 mm

Norm: EN 13964:2014

Notes:

Similar to RAL 7016

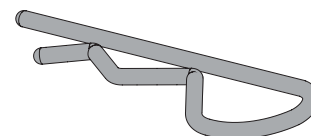

Item number	Description	Order number	Width (mm)	Weight (kg/m/pc)	Package/ Large pack
58107	for Nonius	119474		0,006	100 PC / 600 BOX

Nonius hanger C3-C5 perforated high

Application area: ceiling sub-construct-
ions with vernier suspensions, with increased corrosion
resistance requirements.

Material: Galvanised steel with coating

Material thickness (mm): 1,2 mm

Norm: EN 13964:2014

Norm: DIN18168-2

Notes:

Similar to RAL 7016

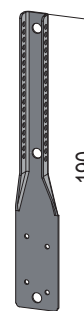

Item number	Description	Length (cm)	Order number	Width (mm)	Weight (kg/m/pc)	Package/ Large pack
58106	for wood hanging	19	110652		0,050	100 PC / 45 BOX

Nonius hanger 90° angle C3-C5 high

Application area: ceiling sub-construct-
ions with vernier suspensions, with increased corrosion
resistance requirements.

Material: Galvanised steel with coating

Material thickness (mm): 1,2 mm

Norm: EN 13964:2014

Norm: DIN18168-2

Notes:

Similar to RAL 7016

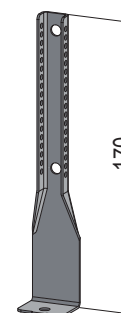

Item number	Description	Order number	Width (mm)	Weight (kg/m/pc)	Package/ Large pack
58317	for wood hanging	116151		0,050	100 PC / 45 BOX

ANTI CORROSION DEFENDO

PRODUCT CLASS 6570

Adjusting strip for Nonius hanger C3-C5 high

Application area: ceiling sub-constructions connected to vernier subdividers with increased corrosion resistance requirements.

Material: Galvanised steel with coating
Material thickness (mm): 1 mm
Norm: EN 13964:2014
Norm: DIN18168-2
Notes:
 Similar to RAL 7016

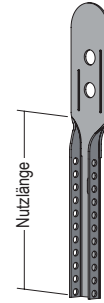

Item number	Description	Order number	Width (mm)	Weight (kg/m/pc)	Package/ Large pack
58109	working length 85 mm	109450		0,025	100 PC / 100 BOX
58110	working length 135 mm	109453		0,035	100 PC / 100 BOX
58111	working length 235 mm	109455		0,056	100 PC / 84 BOX
58112	working length 340 mm	109456		0,075	100 PC / 56 BOX
58113	working length 440 mm	109457		0,090	100 PC / 40 BOX
58114	working length 540 mm	109458		0,105	100 PC / 40 BOX
58115	working length 640 mm	109459		0,126	100 PC / 32 BOX
58116	working length 740 mm	109461		0,150	100 PC / 32 BOX
58117	working length 840 mm	109460		0,165	100 PC / 24 BOX
58118	working length 940 mm	109462		0,175	100 PC / 24 BOX

Adjusting strip for Nonius hanger C3-C5 high

Application area: ceiling sub-constructions connected to vernier subdividers with increased corrosion resistance requirements.

Material: Galvanised steel with coating
Norm: EN 13964:2014
Norm: DIN18168-2
Notes:
 Similar to RAL 7016

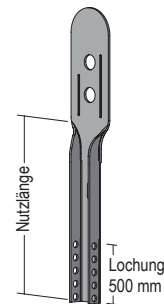

Item number	Description	Order number	Width (mm)	Weight (kg/m/pc)	Package/ Large pack
58123	working length 1140 mm	110168		0,212	50 PC / 40 BOX
58124	working length 1340 mm	110169		0,243	50 PC / 40 BOX
58119	working length 1640 mm	109463		0,310	50 PC / 32 BOX
58125	working length 1940 mm	110170		0,345	50 PC / 32 BOX
58126	working length 2440 mm	110171		0,429	50 PC / 24 BOX

Safety cross connector C3-C5 high

For connecting CD profiles on level sub-constructions with increased corrosion resistance requirements.

Material: Galvanised steel with coating
Material thickness (mm): 0,8 mm
Norm: EN 13964:2014
Norm: DIN18168-2
Load carrying class: 0,40 kN/Paar
Notes:
 Similar to RAL 7016

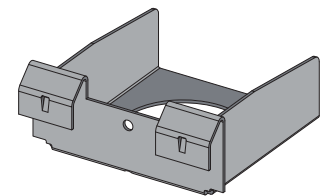

Item number	Description	Order number	Width (mm)	Weight (kg/m/pc)	Package/ Large pack
58105	for C 60-27	110042		0,055	100 PC / 45 BOX

Angle-fixing bracket for UA-profile C3-C5 high

For attaching UA profiles to floors and ceilings with increased corrosion resistance requirements.

Material: Galvanised steel with coating
Material thickness (mm): 2 mm
Notes:
 Similar to RAL 7016

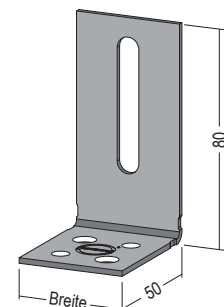

Item number	Description	Length (cm)	Order number	Width (mm)	Weight (kg/m/pc)	Package/ Large pack
59185	for UA 50	8	109835	40	0,098	25 PC / 160 BOX

ANTI CORROSION DEFENDO

PRODUCT CLASS 6570

Angle-fixing bracket for UA-profile C3-C5 high

For attaching UA profiles to floors and ceilings with increased corrosion resistance requirements.

Material: Galvanised steel with coating
Material thickness (mm): 2 mm
Norm: 12944
Notes:
 Similar to RAL 7016

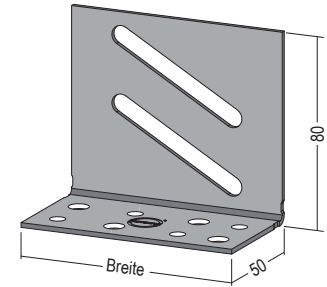

Item number	Description	Length (cm)	Order number	Width (mm)	Weight (kg/m/pc)	Package/ Large pack
59183	for UA 75 / UA 100	8	109834	68	0,169	25 PC / 252 BUN
59182	for UA 100 / UA 125	8	109833	93	0,234	25 PC / 168 BUN

Dry wall screw with trumpet head universal

For connecting panelling materials for sheet metal thicknesses of up to 0.7 mm with double lead thread with increased corrosion resistance requirements.

Material: Galvanised steel with coating
Norm: EN 14566
Norm: DIN18182-2
Notes:
 Similar to RAL 7016

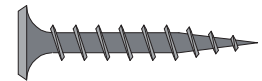

Item number	Description	Length (cm)	Order number	Width (mm)	Weight (kg/m/pc)	Package/ Large pack
58205	TN 3,5 x 25 mm	0	112467		1,000	1000 PC / 384 BOX
58206	TN 3,5 x 25 mm	0	112468		2,000	1000 PC / 288 BOX

Dry wall screw C3-C5 with trumpet head universal

For connecting panelling materials for sheet metal thicknesses of 0.7 to 2.25 mm with increased corrosion resistance requirements.

Material: Galvanised steel with coating
Norm: EN 14566
Norm: DIN18182-2
Notes:
 Similar to RAL 7016

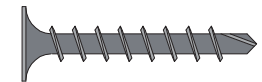

Item number	Description	Length (cm)	Order number	Width (mm)	Weight (kg/m/pc)	Package/ Large pack
58215	TB 3,5 x 25 mm	0	112469		1,000	1000 PC / 384 BOX
58216	TB 3,5 x 35 mm	19	112470		2,000	1000 PC / 288 BOX

Sheet metal screw C3-C5 with flat head and Phillips slot uni

For connecting metal sheets of 0.7 to 2.25 mm in thickness with increased corrosion resistance requirements. Head diameter 11 mm.

Material: Galvanised steel with coating
Norm: EN 14566
Notes:
 Similar to RAL 7016

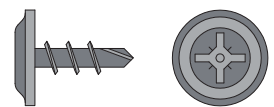

Item number	Description	Length (cm)	Order number	Width (mm)	Weight (kg/m/pc)	Package/ Large pack
58236	4.2 x 13 mm	0	112472		1,500	1000 PC / 384 BOX

Self-tapping screw with oval head C3-C5 universal

For connecting metal sheets of 0.7 to 2.25 mm in thickness with increased corrosion resistance requirements.

Material: Galvanised steel with coating
Notes:
 Similar to RAL 7016

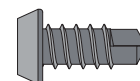

Item number	Description	Length (cm)	Order number	Width (mm)	Weight (kg/m/pc)	Package/ Large pack
58227	3,8 x 11,1 mm	0	118345		1,000	1000 PC / 384 BOX

ANTI CORROSION DEFENDO

PRODUCT CLASS 6570

Sheet metal screw C3-C5 with flat head and Phillips slot uni

For connecting metal sheets of up to 0.7 mm in thickness with increased corrosion resistance requirements.

Material: Galvanised steel with coating
Norm: EN 14566
Norm: DIN18168-2
Notes:
 Similar to RAL 7016

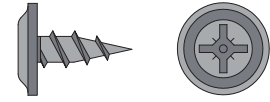

Item number	Description	Length (cm)	Order number	Width (mm)	Weight (kg/m/pc)	Package/ Large pack
58239	4.2 x 13 mm	0	112473		1,000	1000 PC / 384 BOX

Mounting set M 8 x 20 / spanner size 13 C3-C5 universal

For connecting UA profiles with connection angles. Comprised of flat-head screws with special DIN 603/4.6 square necks, with washer and nut.

Material: Galvanised steel with coating
Notes:
 black

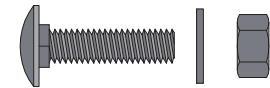

Item number	Description	Length (cm)	Order number	Width (mm)	Weight (kg/m/pc)	Package/ Large pack
58203	for door frames	0	109829		0,021	100 PC / 350 BOX

Touch-up paint universal

For treating interfaces and minor scratches on site. Spray can: Contents 0.4 l Please ensure thick application, approx. 200 µm

Material:
Notes:
 Similar to RAL 7016



Item number	Description	Length (cm)	Order number	Width (mm)	Weight (kg/m/pc)	Package/ Large pack
58150		27	109712		0,450	12 PC / 84 BOX

Ceiling dowel with nail C3

Application area: Exterior areas and wet areas not subject to aggressive conditions.

Material: Stainless steel A4

European Technical Approval: ETA-09-0313



Item number	Description	Length (cm)	Order number	Width (mm)	Weight (kg/m/pc)	Package/ Large pack
58220	6 x 45 mm	4	111945		0,010	100 PC / 880 BOX

Ceiling dowel with nail head C4-C5

Application area: chlorinated atmospheres, atmospheres with extreme levels of chemical pollution, swimming halls, brine baths.

Material: Stainless steel 1.4529

European Technical Approval: ETA-09-0313



Item number	Description	Length (cm)	Order number	Width (mm)	Weight (kg/m/pc)	Package/ Large pack
58221	6 x 45 mm	4	111946		0,010	100 PC / 880 BOX



EXPERIENCE THE DIFFERENCE

Special construction elements for ceilings and walls prevent sound passing through them e.g. under a wooden beam ceiling, for wooden frame buildings and when renovating old buildings. New constructions can also gain more peace and quiet from this technically smart solution, improving the quality of life. Built-in relaxation.

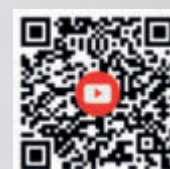

Product video
View now »

SOUND INSULATION SILENCIO

PRODUCT CLASS 6530

TPS C-ceiling profile

Application area: ceiling profile impact sound protection systems underneath wooden beam ceilings.

Material: Galvanised steel
Material thickness (mm): 0,6 mm
Norm: EN 14195

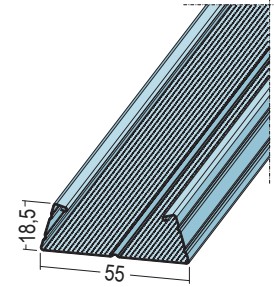

Item number	Description	Length (cm)	Order number	Width (mm)	Weight (kg/m/pc)	Package/ Large pack
5104	C 55-18,5	400	100101	55	0,495	12 PCS / 40 BUN

TPS-U-wall connection profile

Application area: connection profile for TPS profiles on impact sound protection systems underneath wooden beam ceilings.

Material: Galvanised steel
Material thickness (mm): 0,56 mm
Norm: EN 14195

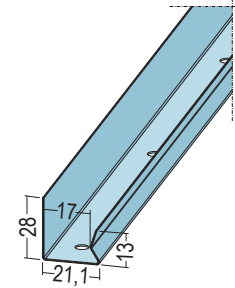

Item number	Description	Length (cm)	Order number	Width (mm)	Weight (kg/m/pc)	Package/ Large pack
5313	for Item no. 5104	300	114096		0,250	12 PCS / 20 BUN

TPS-CD-connector

For creating a lengthwise connection of TPS profiles for impact sound insulation underneath wooden beam ceilings.

Material: Galvanised steel
Material thickness (mm): 0,6 mm

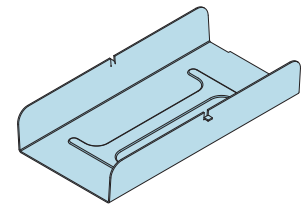

Item number	Description	Order number	Width (mm)	Weight (kg/m/pc)	Package/ Large pack
6127	for 5104	101337		0,048	100 PC / 80 BOX

TPS-spring clip FN 4,2 x 35 mm adjustable with screws

For attaching TPS profiles for impact sound insulation underneath wooden beam ceilings. Includes 200 wooden screws, FN 4.2 x 35 mm (art. no. 6242)
 Max. load $f \approx 0.08$ kN (8 kg) per spring clip

Material: Galvanised steel
Material thickness (mm): 0,7 mm
Norm: EN 13964
DIN test standard: DIN 18168-2

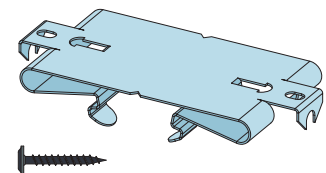

Item number	Description	Order number	Width (mm)	Weight (kg/m/pc)	Package/ Large pack
6126	for 5104	109714		0,058	100 PC / 45 BOX

RC-profile

Application area: walls/wall facings.
 Horizontal installation.

Material: Galvanised steel
Material thickness (mm): 0,6 mm
Norm: EN 14195

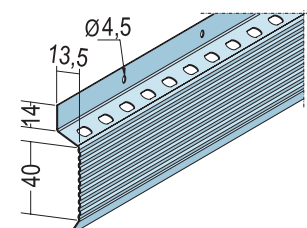

Item number	Description	Length (cm)	Order number	Width (mm)	Weight (kg/m/pc)	Package/ Large pack
5100	for facing shell	300	103576		0,380	10 PCS / 50 BUN

SOUND INSULATION SILENCIO

PRODUCT CLASS 6530

Hat spring rail

Application area: underneath wooden ceiling beams for improving sound insulation.

Material: Galvanised steel
Material thickness (mm): 0,6 mm
Norm: EN 14195

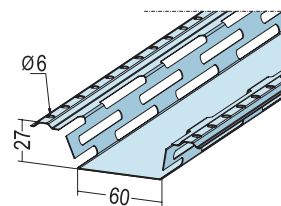

Item number	Description	Length (cm)	Order number	Width (mm)	Weight (kg/m/pc)	Package/ Large pack
5007	60-27-06	400	117203		0,791	10 PCS / 54 BUN

U-hanger acoustically insulated for CD 60-27

For attaching CD profiles on hanging ceiling sub-constructions for improving sound insulation.

Material: Galvanised steel
Material thickness (mm): 0,9 mm
Norm: EN 13964
DIN test standard: DIN 18168-2
Load carrying class: 0,40 kN

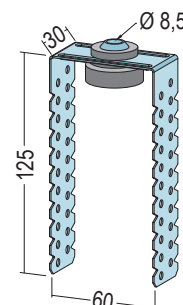

Item number	Description	Order number	Width (mm)	Weight (kg/m/pc)	Package/ Large pack
6160	125 mm	107907		0,072	100 PC / 45 BOX

U-hanger flat acoustically insulated

For attaching CD profiles on hanging ceiling sub-constructions for improving sound insulation.

Material: Galvanised steel
Material thickness (mm): 0,9 mm
Norm: EN 13964:2014
Norm: DIN18168-2
Load carrying class: 0,40 kN

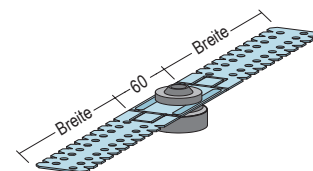

Item number	Description	Order number	Width (mm)	Weight (kg/m/pc)	Package/ Large pack
56369	70 mm	109842	70	0,058	100 PC / 50 BOX
56367	125 mm	109844	125	0,072	100 PC / 50 BOX
56359	200 mm	109843	200	0,094	100 PC / 20 BOX

Click-Fix Track mounting acoustically insulated

For attaching CD profiles on hanging ceiling sub-constructions for improving sound insulation.

Material: Galvanised steel
Material thickness (mm): 1 mm
Norm: EN 13964:2014
Norm: DIN18168-2
Load carrying class: 0,40 kN

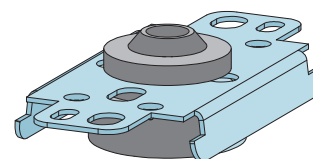

Item number	Description	Order number	Width (mm)	Weight (kg/m/pc)	Package/ Large pack
56393	for C 60-27	112115		0,042	100 PC / 80 BOX

Adjustable direct hanging acoustically insulated for C 60-27

For attaching CD profiles on hanging ceiling sub-structures to improve sound insulation. 2-pieces, includes safety clamps. Use washers for wooden beam screw joints.

Material: Galvanised steel
Material thickness (mm): 1 mm
Norm: EN 13964:2014
Norm: DIN18168-2
Load carrying class: 0,40 kN

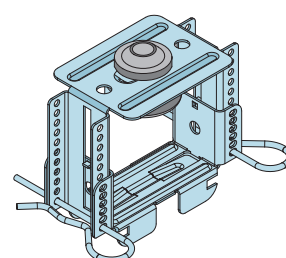

Item number	Description	Order number	Width (mm)	Weight (kg/m/pc)	Package/ Large pack
56311	50 - 80 mm	115612		0,100	50 PC / 48 BOX
56310	69 - 118 mm	115611		0,115	50 PC / 32 BOX

SOUND INSULATION SILENCIO

PRODUCT CLASS 6530

Adjusting strip for Nonius hanger acoustically insulated

Application area: ceiling sub-constructions connected to vernier subdividers for improving wall facings.

Material: Galvanised steel
Material thickness (mm): 1 mm
Norm: EN 13964:2014
Norm: DIN18168-2

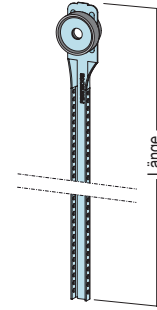

Item number	Description	Order number	Width (mm)	Weight (kg/m/pc)	Package/ Large pack
56321	190 mm	109846		0,049	100 PC / 80 BOX
56322	290 mm	109847		0,070	100 PC / 50 BOX
56323	390 mm	109848		0,089	100 PC / 24 BOX
56324	490 mm	109849		0,104	100 PC / 15 BOX
56325	590 mm	109850		0,119	100 PC / 12 BOX
56326	690 mm	109851		0,140	100 PC / 15 BOX

Wire with eye acoustically insulated

Application area: ceiling sub-constructions connected to suspension hangers for improving wall facings.

Material: Steel wire, galvanised
Material thickness (mm): 4 mm
Norm: EN 13964:2014

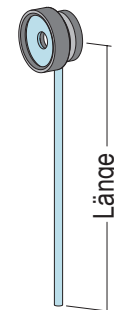

Item number	Description	Length (cm)	Order number	Width (mm)	Weight (kg/m/pc)	Package/ Large pack
56342	250 mm	25	109853		0,041	100 PC / 50 BOX
56344	500 mm	50	109854		0,065	100 PC / 16 BOX

Acoustic insulated element

For attaching accessories with \varnothing 12-mm perforations. 3-piece acoustic insulation element (upper, lower parts and washer).

Material:

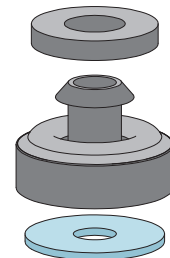

Item number	Description	Length (cm)	Order number	Width (mm)	Weight (kg/m/pc)	Package/ Large pack
56300		0	109841		0,014	100 PC / 80 BOX

Spring clamp

For attaching wooden slats to improve sound insulation.
 maximum load $f \leq 0,10$ kN

Material: Galvanised steel
Material thickness (mm): 0,7 mm
Norm: EN 13964:2014

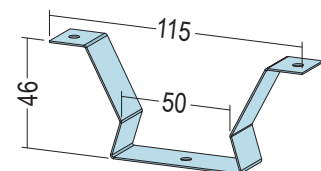

Item number	Description	Order number	Width (mm)	Weight (kg/m/pc)	Package/ Large pack
6129	for spring hanging	101342		0,018	250 PC / 36 BOX

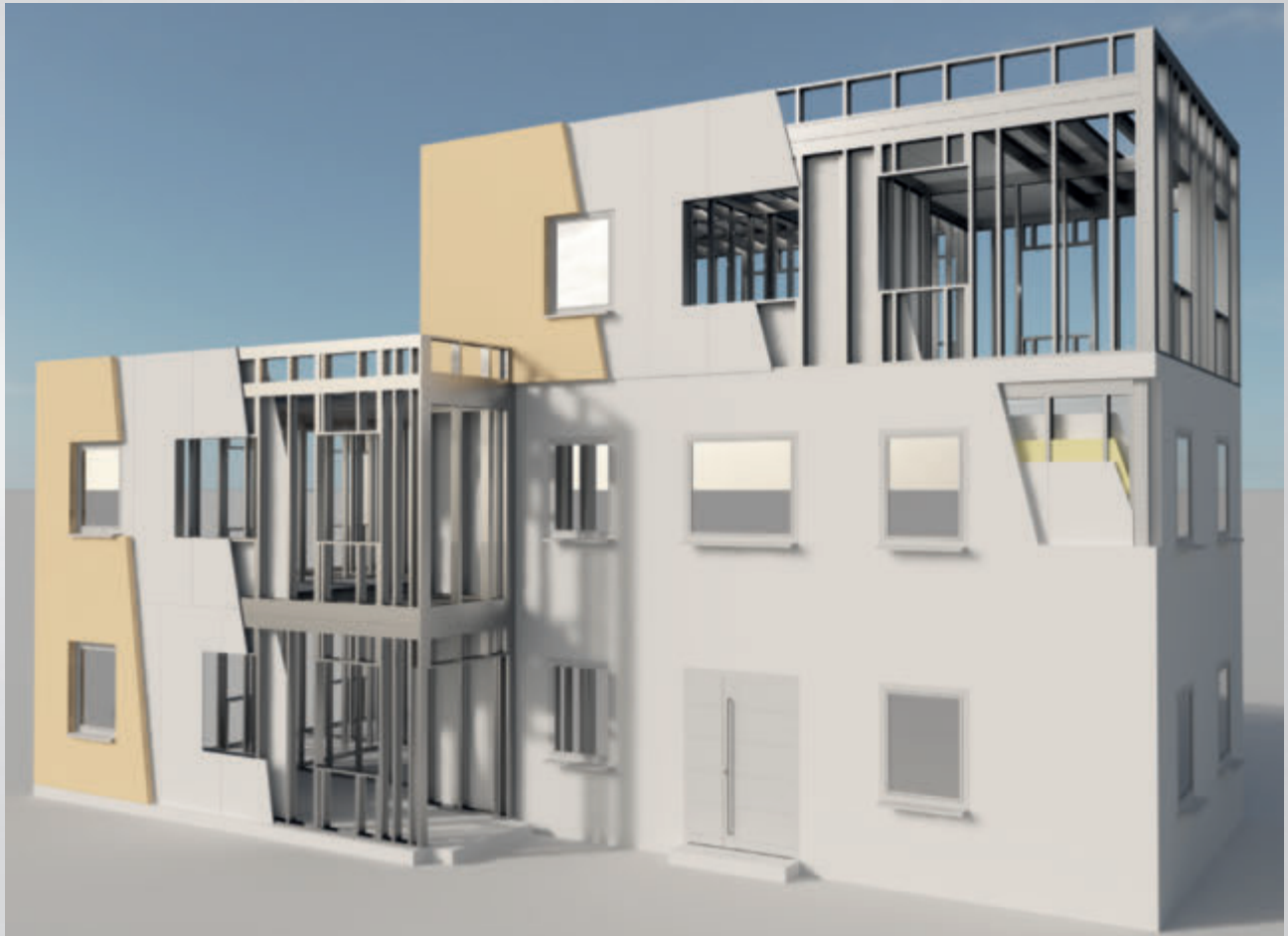

EDIFICIO – THE PROFESSIONAL LIGHTGAUGE STEEL CONSTRUCTION SYSTEM DEVELOPED BY PROTEKTOR

Many tasks are easier to complete with edificio, the light-weight steel construction system made by Protektor. Extensions, refurbishments, new buildings, façades are just some of the projects that can be executed quickly and accurately with this construction method.

Cold formed C and U profiles form the basis for edificio light-gauge steel structures. The procedure for installation is accepted by dry wall experts and is seamlessly integrated into existing routine workflows.

You can find further details in our special brochures.



Product video

View now »



LIGHTWEIGHT STEEL CONSTRUCTION EDIFICIO

PRODUCT CLASS 6550

C-wide span beam profiles

Application area: wide span supports for free-spanning or hanging ceilings.

Material: Galvanised steel
Material thickness (mm): 2 mm
Norm: EN 14195:2005

Item number	Description	Length (cm)	Order number	Width (mm)	Weight (kg/m/pc)	Package/ Large pack
5127	Typ C102	400	100408	102,5	2,500	1 PCS / 96 PCS
	Typ C102	600	100420	102,5	2,500	1 PCS / 96 PCS

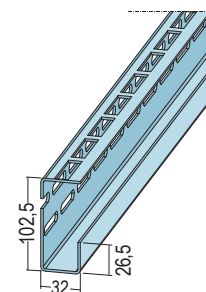

U-beam/wall profile

Application area: wall profile for walls or wide span supports for free-spanning ceilings.

Material: S320 GD+Z
Material thickness (mm): 1,5 mm
Norm: EN 1090-1

Item number	Description	Length (cm)	Order number	Width (mm)	Weight (kg/m/pc)	Package/ Large pack
4705	50-50-15	300	117187		1,680	6 PCS / 15 BUN

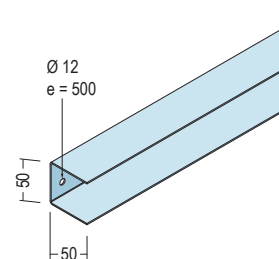

C-beam/wall profile

Application area: wall profile for walls or wide span supports for free-spanning ceilings.

Material: S320 GD + ZM
Material thickness (mm): 1,5 mm
Norm: EN 1090-1
Notes:
 Fixlänge auf Anfrage

Item number	Description	Length (cm)	Order number	Width (mm)	Weight (kg/m/pc)	Package/ Large pack
4710	97-50-15	500	118839	97	2,355	1 PCS / 84 BUN
	97-50-15	600	118840	97	2,355	1 PCS / 84 BUN
4715	147-50-15	400	118842	147	2,935	1 PCS / 72 BUN
	147-50-15	500	111652	147	2,935	1 PCS / 72 PCS
	147-50-15	500	118843	147	2,935	1 PCS / 72 BUN

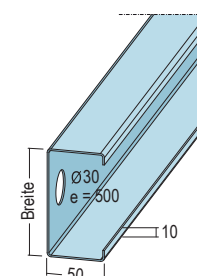

C-beam/wall profile

Application area: wall profile for walls or wide span supports for free-spanning ceilings.

Material: S320 GD+Z
Material thickness (mm): 2 mm
Norm: EN 1090-1
Notes:
 Fixlänge auf Anfrage

Item number	Description	Length (cm)	Order number	Width (mm)	Weight (kg/m/pc)	Package/ Large pack
4810	97-50-20	400	118845	97	3,150	1 PCS / 84 BUN
	97-50-20	500	118846	97	3,150	1 PCS / 84 BUN
	97-50-20	600	111656	97	3,150	1 PCS / 84 BUN
	97-50-20	600	118847	97	3,150	1 PCS / 84 BUN
4815	147-50-20	400	118848	147	3,940	1 PCS / 72 BUN
	147-50-20	500	111658	147	3,940	1 PCS / 72 BUN

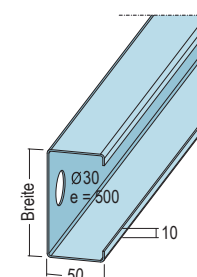

LIGHTWEIGHT STEEL CONSTRUCTION EDIFICIO

PRODUCT CLASS 6550

U-beam profile

Application area: wide span supports on free-spanning ceilings.

Material: S320 GD+Z
Material thickness (mm): 1,5 mm
Norm: EN 1090-1
Notes:
 Fixlänge auf Anfrage

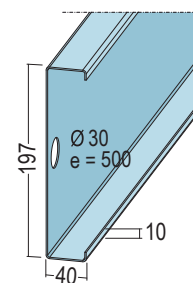

Item number	Description	Length (cm)	Order number	Width (mm)	Weight (kg/m/pc)	Package/ Large pack
4419	197-40-15	400	111640	197	3,370	1 PCS / 60 PCS

U-beam profile

Application area: wide span supports on free-spanning ceilings.

Material: S320 GD+Z
Material thickness (mm): 2 mm
Norm: EN 1090-1
Notes:
 Fixlängen auf Anfrage

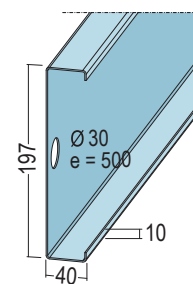

Item number	Description	Length (cm)	Order number	Width (mm)	Weight (kg/m/pc)	Package/ Large pack
4519	197-40-20	400	111644	197	4,480	1 PCS / 60 PCS
	197-40-20	500	111645	197	4,480	1 PCS / 60 PCS
	197-40-20	600	111646	197	4,480	1 PCS / 60 PCS

U-beam profile

Application area: wide span supports on free-spanning ceilings.

Material: S320 GD+Z
Material thickness (mm): 2 mm
Norm: EN 1090-1
Notes:
 No stock goods, only order-related fixed length.
 Lengths > 800 cm on request

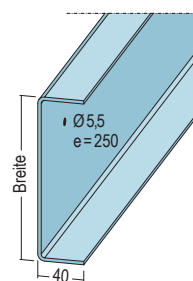

Item number	Description	Length (cm)	Order number	Width (mm)	Weight (kg/m/pc)	Package/ Large pack
4525	247-40-20	400	115808	247	5,085	1 PCS / 50 PCS
4529	297-40-20	400	115809	297	5,865	1 PCS / 50 PCS

U-beam profile

Application area: wide span supports on free-spanning ceilings.

Material: S320 GD+Z
Material thickness (mm): 3 mm
Norm: EN 1090-1
Notes:
 No stock goods, only order-related fixed length.
 Lengths > 800 cm on request

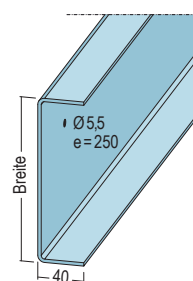

Item number	Description	Length (cm)	Order number	Width (mm)	Weight (kg/m/pc)	Package/ Large pack
4914	147-40-30	400	115810	147	5,238	1 PCS / 50 PCS
4918	197-40-30	400	106591	197	6,408	1 PCS / 50 PCS
4923	247-40-30	400	115811	247	7,578	1 PCS / 50 PCS
4929	297-40-30	400	115812	297	8,748	1 PCS / 50 PCS

LIGHTWEIGHT STEEL CONSTRUCTION EDIFICIO

PRODUCT CLASS 6550

U-connection profile

Application area: supporting bracket for wide span supports on free-spanning or free-hanging ceilings.

Material: S320 GD+Z
Material thickness (mm): 2 mm
Norm: EN 14195:2005

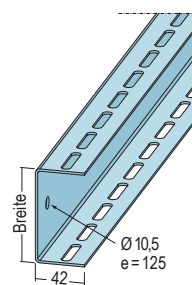

Item number	Description	Length (cm)	Order number	Width (mm)	Weight (kg/m/pc)	Package/ Large pack
5138	for Item no. 5127	400	100585	108	3,500	1 PCS / 200 PCS

U-connection profile

Application area: connection profile for walls or free-spanning ceilings.

Material: S320 GD+Z
Material thickness (mm): 1,5 mm
Norm: EN 1090-1

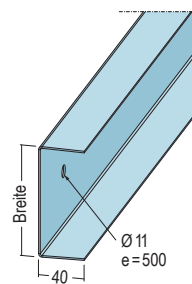

Item number	Description	Length (cm)	Order number	Width (mm)	Weight (kg/m/pc)	Package/ Large pack
4410	100-40-15	500	114234	100	2,050	1 PCS / 96 PCS
	100-40-15	500	118857	100	2,050	1 PCS / 96 BUN
4415	150-40-15	500	114235	150	2,650	1 PCS / 72 PCS
	150-40-15	500	118858	150	2,650	1 PCS / 72 BUN
4420	200-40-15	500	118859	200	3,230	1 PCS / 60 BUN

U-connection profile

Einsatzbereich als Anschlussprofil für Wände oder freigespannte Decken.

Material: S320 GD+Z
Norm: EN 1090-1
Material thickness (mm): 2 mm

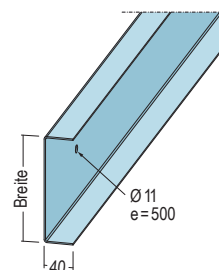

Item number	Description	Length (cm)	Order number	Width (mm)	Weight (kg/m/pc)	Package/ Large pack
4510	101-40-20	500	118860	101	2,050	1 PCS / 96 BUN
4515	151-40-20	500	118861	151	2,650	1 PCS / 72 BUN
4520	201-40-20	500	114241	201	3,230	1 PCS / 60 PCS

U-connection profile

Einsatzbereich als Anschlussprofil für freigespannte Decken.

Material: S320 GD+Z
Material thickness (mm): 2 mm
Notes:
 Keine Lagerware, nur auftragsbezogene Fixlängen.

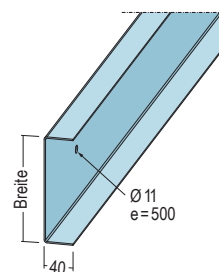

Item number	Description	Length (cm)	Order number	Width (mm)	Weight (kg/m/pc)	Package/ Large pack
4427	251-40-20	400	106577	251	5,138	1 PCS / 50 PCS
4530	301-40-20	400	106528	301	5,928	1 PCS / 50 PCS

ediWall U-connection profile ZM

Einsatzbereich als Anschlussprofil für Wände

Material: S320 GD + ZM
Material thickness (mm): 2 mm
Norm: EN 1090-1

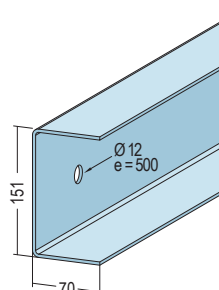

Item number	Description	Length (cm)	Order number	Width (mm)	Weight (kg/m/pc)	Package/ Large pack
44772	151-70-20	500	118145	151	4,460	2 PCS / 2 BUN

LIGHTWEIGHT STEEL CONSTRUCTION EDIFICIO

PRODUCT CLASS 6550

U-ring tie profile

Application area: upper connection profile on load-bearing walls.

Material: S320 GD+Z
Material thickness (mm): 1,5 mm

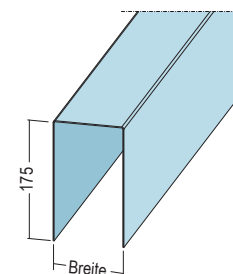

Item number	Description	Length (cm)	Order number	Width (mm)	Weight (kg/m/pc)	Package/ Large pack
4610	100-175-15	500	114916	100	5,265	1 PCS / 50 PCS
4615	150-175-15	500	115551	150	5,850	1 PCS / 50 PCS

U-ring tie profile angled

Application area: upper connection profile on load-bearing walls,

Material: S320 GD+Z
Notes:
 Inclination must be specified with the order, max, 20 °,

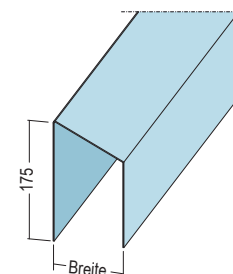

Item number	Description	Length (cm)	Order number	Width (mm)	Weight (kg/m/pc)	Package/ Large pack
4611	100-175-15	500	114017		5,265	1 PCS / 50 BUN
4616	150-175-15	500	114018		5,850	1 PCS / 50 BUN

Supporting bracket

Application area: supporting bracket for wide span supports on free-hanging ceilings.

Material: S320 GD+Z
Material thickness (mm): 3 mm

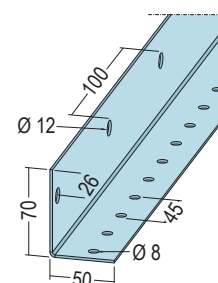

Item number	Description	Length (cm)	Order number	Width (mm)	Weight (kg/m/pc)	Package/ Large pack
5503	70-50-30	400	111844		2,340	1 PCS / 125 PCS

Supporting bracket

Application area: supporting bracket for wide span supports on free-hanging ceilings.

Material: S320 GD+Z
Material thickness (mm): 4 mm

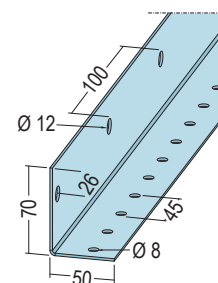

Item number	Description	Length (cm)	Order number	Width (mm)	Weight (kg/m/pc)	Package/ Large pack
5502	70-50-40	400	111843		3,120	1 PCS / 100 PCS

profile as tilting protection

Safety against tilting in the upper part of wide span beams.
 e≤1500 mm

Material: Galvanised steel
Material thickness (mm): 2 mm
Norm: EN 14195:2005
DIN test standard: DIN 18168-2

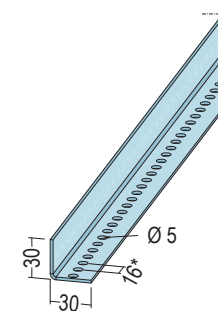

Item number	Description	Length (cm)	Order number	Width (mm)	Weight (kg/m/pc)	Package/ Large pack
5198	30 x 30 mm	400	114440	30	0,887	8 PCS / 25 BUN

LIGHTWEIGHT STEEL CONSTRUCTION EDIFICIO

PRODUCT CLASS 6550

Installation level profile

For creating an installation level (42.5 mm) in the wall area. Installation is horizontal.

Material: Galvanised steel
Material thickness (mm): 0,6 mm

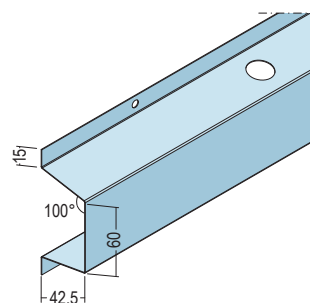

Item number	Description	Length (cm)	Order number	Width (mm)	Weight (kg/m/pc)	Package/ Large pack
4364	42,5 mm	300	115078		0,801	10 PCS / 200 BUN

Wall fixing angle

For attaching wide span supports to the wall or for creating replacements.

Material: Galvanised steel
Material thickness (mm): 3 mm

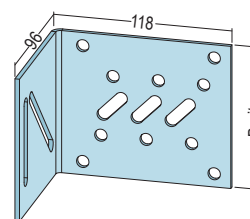

Item number	Description	Length (cm)	Order number	Width (mm)	Weight (kg/m/pc)	Package/ Large pack
6172	for C 102	0	107361	97	0,397	1 PC / 25 PC

Wall fixing angle

For mounting wide span supports with threaded rods.

Material: Galvanised steel
Material thickness (mm): 10 mm

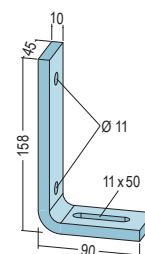

Item number	Description	Length (cm)	Order number	Width (mm)	Weight (kg/m/pc)	Package/ Large pack
6184	158 x 90 x 45 mm	0	101498		0,720	1 PC / 25 PC

Support-reinforcements

For tilt protection in the support area of wide span supports.

Material: S320 GD+Z
Material thickness (mm): 4 mm

Item number	Description	Length (cm)	Order number	Width (mm)	Weight (kg/m/pc)	Package/ Large pack
4540	TA 100-40	0	106579	90	0,362	1 PC / 25 PC
4541	TA 150-40	0	106580	123	0,407	1 PC / 25 PC
4542	TA 200-40	0	106581	148	0,587	1 PC / 25 PC
4543	TA 250-40	0	106582	173	0,587	1 PC / 25 PC
4544	TA 300-40	0	106583	202	0,684	1 PC / 25 PC

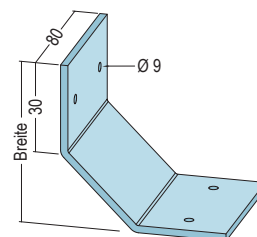

Connection angle

For attaching wide span supports to the wall or for creating replacements.

Material: S320 GD+Z
Material thickness (mm): 2 mm

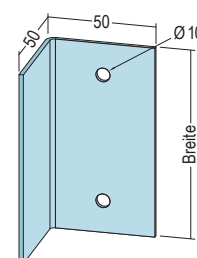

Item number	Description	Length (cm)	Order number	Width (mm)	Weight (kg/m/pc)	Package/ Large pack
4550	AW 90-20 50x50	9	115107	90	0,079	25 PC / 252 BUN
4551	AW 140-20 50x50	14	115108	140	0,119	25 PC / 252 BUN

LIGHTWEIGHT STEEL CONSTRUCTION EDIFICIO

PRODUCT CLASS 6550

Connection angle perforated on both sides

For attaching wide span supports to the wall or for creating replacements.

Material: S320 GD+Z
Material thickness (mm): 2 mm

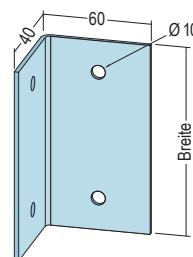

Item number	Description	Length (cm)	Order number	Width (mm)	Weight (kg/m/pc)	Package/ Large pack
4554	AW 90-20 60x40	9	115428	90	0,079	25 PC / 252 BUN
4558	AW 140-20 60x40	14	115429	140	0,119	25 PC / 252 BUN

Connection angle

For attaching wide span supports to the wall or for creating replacements.

Material: S320 GD+Z
Material thickness (mm): 4 mm

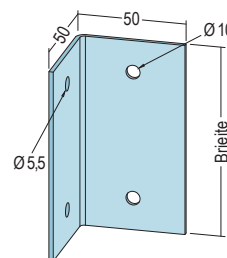

Item number	Description	Length (cm)	Order number	Width (mm)	Weight (kg/m/pc)	Package/ Large pack
4552	AW 90-40 50x50	9	106586	90	0,351	1 PC / 25 PC
4553	AW 140-40 50x50	14	106587	140	0,546	1 PC / 25 PC

Connecting bracket

Anschlusswinkel zur Befestigung von C-Ständerprofile bei Wandöffnungen in nicht tragenden Außenwänden.

Material: S320 GD+Z
Material thickness (mm): 2 mm
Load carrying class: k.A.

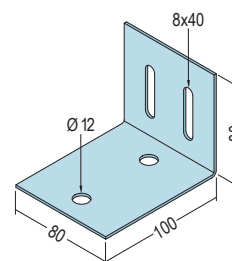

Item number	Description	Length (cm)	Order number	Width (mm)	Weight (kg/m/pc)	Package/ Large pack
4548	L 100 x 80 x 2mm	0	116690	80	0,226	25 PC / 40 BUN

ediWall Holding clip

Halteklammer zur Fixierung der C-Ständerprofile bei gleitendem Deckenanschluss bei nicht tragenden eingestellten Außenwänden

Material: Galvanised steel
Material thickness (mm): 1 mm

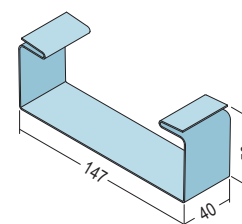

Item number	Description	Length (cm)	Order number	Width (mm)	Weight (kg/m/pc)	Package/ Large pack
4597	150	0	116688	147	0,104	25 PC / 40 BOX

Adapter

For mounting wide span supports with threaded rods.

Material: S320 GD+Z
Material thickness (mm): 4 mm

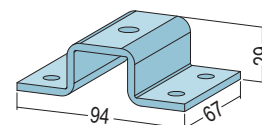

Item number	Description	Length (cm)	Order number	Width (mm)	Weight (kg/m/pc)	Package/ Large pack
6186		9	106079		0,300	1 PC / 25 PC

LIGHTWEIGHT STEEL CONSTRUCTION EDIFICIO

PRODUCT CLASS 6550

Galvanised threaded rod set M10 8.8

Zur Abhängung von Weitspannträgerkonstruktionen mit Gewindestange.

Bestehend aus:

10 Stk verz. Gewindestangen M10 8.8

20 Stk verz. Flanschmutter M10 Güte 8 Zn

20 Stk verz. Mutter M10 Güte 8 Zn

Material: Galvanised steel

Item number	Description	Length (cm)	Order number	Width (mm)	Weight (kg/m/pc)	Package/ Large pack
6558	2000 mm	200	115467		10,100	1 SET / 50 BOX

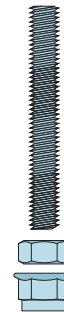

Suspension clamp

For mounting threaded bars, Ø 10mm, onto IP beams with a max. flange thickness of 24 mm. Lower section with joint.

Material: Galvanised steel

Item number	Description	Length (cm)	Order number	Width (mm)	Weight (kg/m/pc)	Package/ Large pack
6586	flange 2-24 mm	0	102067		0,275	1 PC / 50 PC

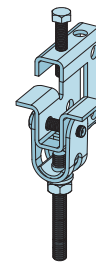

Suspension clamp

For mounting threaded bars, Ø 10mm, onto IP beams with a max. flange thickness of 20 mm.

Material: Galvanised steel

Item number	Description	Length (cm)	Order number	Width (mm)	Weight (kg/m/pc)	Package/ Large pack
6587	flange 2-20 mm	0	102068		0,220	1 PC / 50 PC

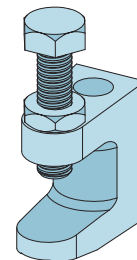

Ground plate

For distributing loads when mounting wide span supports with threaded rods.

Material: Galvanised steel
Material thickness (mm): 5 mm

Item number	Description	Length (cm)	Order number	Width (mm)	Weight (kg/m/pc)	Package/ Large pack
6589	10,5 mm	6	102073		0,071	25 PC / 110 BOX

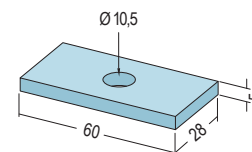

Beam clamp set

For securing wide span supports onto steel beams with flange thicknesses of up to 25 mm.

Material: Galvanised steel

Item number	Description	Length (cm)	Order number	Width (mm)	Weight (kg/m/pc)	Package/ Large pack
6588	M10x50 for C102	0	102070		0,170	10 PC / 240 BOX
6590		0	105745		0,169	10 PC / 240 BOX

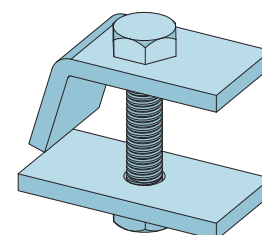

LIGHTWEIGHT STEEL CONSTRUCTION EDIFICIO

PRODUCT CLASS 6550

Suspension clamp

For securing vernier shells to steel beams.
Vertical installation.

Material: Spring steel, galvanized

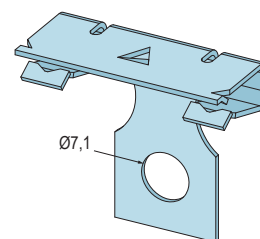

Item number	Description	Length (cm)	Order number	Width (mm)	Weight (kg/m/pc)	Package/ Large pack
6580	for 2-3 mm	0	102057		0,014	100 PC / 50 BOX
6585	flange 8-14 mm	0	108289		0,014	100 PC / 50 BOX

Suspension clamp

For securing vernier shells to steel beams.
Vertical installation.

Material: Spring steel, galvanized

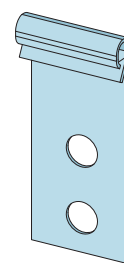

Item number	Description	Length (cm)	Order number	Width (mm)	Weight (kg/m/pc)	Package/ Large pack
6582		0	103111		0,009	100 PC / 40 BOX

Super TEKS screw

For use with a sheet metal thickness of up to 6.0 mm.

Material: Galvanised steel

European Technical Approval: ETA-10/0182

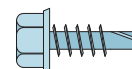

Item number	Description	Length (cm)	Order number	Width (mm)	Weight (kg/m/pc)	Package/ Large pack
6234	6.3 x 19 mm SW 8	0	118480		2,650	500 PC / 250 BOX

Connecting screw SL4

Self-drilling screw for connecting edificio light-weight steel profiles.
 $\sum_{\max} t1+t2: 4.0 \text{ mm}$

Material: Galvanised steel

Notes:
Bit art. no. 6490 required for processing



Item number	Description	Length (cm)	Order number	Width (mm)	Weight (kg/m/pc)	Package/ Large pack
NEW 4591	4,8 x 16 mm	0	116327		2,000	1000 PC / 260 BOX

Bit for connecting screw SL4

Bit for processing the connecting screw SL4 art. no. 4591

Material: Galvanised steel

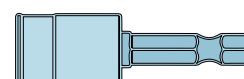

Item number	Description	Length (cm)	Order number	Width (mm)	Weight (kg/m/pc)	Package/ Large pack
NEW 6490	square 6x6 mm	0	116322		0,500	1 PC / 12 PC

LIGHTWEIGHT STEEL CONSTRUCTION EDIFICIO

PRODUCT CLASS 6550

Thread forming screw

for connecting steel components to each other.
 Σ max. t1 + t2: 13.0 mm
 Pre-drilling of the steel components necessary.
 European Technical Approval: ETA-11/0191

Material: Galvanised steel



Item number	Description	Length (cm)	Order number	Width (mm)	Weight (kg/m/pc)	Package/ Large pack
NEW 4593	hexagon head 16 mm TDBLF-T-10,6x23	16	118943		0,025	100 PC / 275 BOX

Impact screw insert with magnet

Insert for impact screw for the use of the screw
 Art.-No. 4593

Material: Galvanised steel



Item number	Description	Length (cm)	Order number	Width (mm)	Weight (kg/m/pc)	Package/ Large pack
NEW 6491	for art. no. 4593	0	119037		0,335	1 PC / 40 PC

profile as tilting protection

Safety against tilting in the upper part of wide span beams with increased corrosion protection

Material: Galvanised steel with coating

Norm: EN 14195:2005

DIN test standard: DIN 18168-2

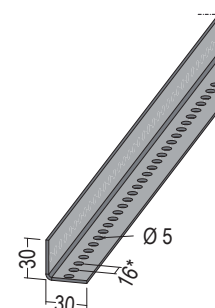

Item number	Description	Length (cm)	Order number	Width (mm)	Weight (kg/m/pc)	Package/ Large pack
59198	30 x 30 mm	400	114625		0,887	8 PCS / 25 BUN

Nonius hanger C3-C5

For attaching CD profiles on ceiling sub-constructions with vernier suspensions increased corrosion resistance.

For external ceilings with suspension heights of 500 - 1000 mm

Material: Galvanised steel with coating

Material thickness (mm): 1,2 mm

Norm: EN 13964:2014

Norm: DIN18168-2

Coating norm: DIN EN ISO 12944

Load carrying class: 0,25

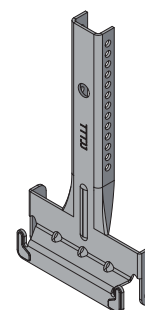

Item number	Description	Length (cm)	Order number	Width (mm)	Weight (kg/m/pc)	Package/ Large pack
4599	for exterior ceilings	12	118390		0,048	100 PC / 51 BOX



SUPPORTS AND DOOR SYSTEMS

When conventional c-stud profiles and reinforced profiles reach their limits, the supports of Protektor form the right basis to safely absorb high static forces. The height-adjustable supports are easy to assemble without welding and are ideally suited for the installation of heavy doors, fire doors, radiators and heavy-duty equipment.

The pre-punched door lintel profiles from Protektor are designed to fit the DIN body-in-white opening dimensions.

The passagio sliding door element made of galvanised steel is suitable for installation with wooden frames. Suitable for three door widths: 610 mm, 735 mm and 860 mm and two door heights: 1985 mm and 2110 mm. Removable running track, with damping on both sides as standard. Guides on the installation element for direct installation in the drywall. Maximum door leaf thickness: 42 mm

Other available accessories:

- ▶ The connecting element for creating a double door
- ▶ The extension set for special heights up to 2700 mm
- ▶ The extension set for glass doors up to 100 kg

 **passagio**
SUPPORTS AND DOOR SYSTEMS

SUPPORTS AND DOOR SYSTEMS

PRODUCT CLASS 6400



SUPPORTS AND DOOR SYSTEMS

When conventional c-stud profiles and reinforced profiles reach their limits, the supports of Protektor form the right basis to safely absorb high static forces. The height-adjustable supports are easy to assemble without welding and are ideally suited for the installation of heavy doors, fire doors, radiators and heavy-duty equipment.

Up to a door leaf weight of 800 kg, the telescopic supports can be individually adapted to different room heights and form a sliding connection in the event of a possible ceiling deflection. The primed system is immediately ready for use and does not require extensive post-treatment. Protektor Passagio - Your support for drywall construction.

Load table for telescopic props

Pipe cross-section	Shell height	Max. door leaf weights
50 x 50 x 4 mm	4,00 m	160 kg
75 x 50 x 4 mm	4,00 m	480 kg
100 x 50 x 4 mm	4,00 m	800 kg



Assessment basis:

- Door size 1.00 x 2.13 m
- Door leaf weight per leaf
- Max. Floor construction 20 cm
- Lowering of the door leaf at the top max. 5 mm
- Installation range $2 \geq$ horizontal Payload $q = 1.0 \text{ kN/m}$
- Wall panelling on both sides with at least $2 \times 12.5 \text{ mm}$ per side
- Fasteners and choice of floor and ceiling connection according to static Requirements and manufacturer information

The dimensioning of the door post profiles must be approved by the responsible Structural engineer/test structural engineer.

SUPPORTS AND DOOR SYSTEMS PASSAGIO

SUPPORTS AND DOOR SYSTEMS PASSAGIO

Telescopic support 50 x 50 x 4 mm

For mounting heavy doors, fire doors, radiators and heavy duty equipment.

Material thickness (mm): 4 mm
Material: Galvanised steel

Item number	Description	Length (cm)	Order number	Width (mm)	Weight (kg/m/pc)	Package/ Large pack
6605	2,47 - 2,75 m	275	119917		16,300	1 PC / 10 PC
6606	2,72 - 3,00 m	300	119919		17,700	1 PC / 10 PC
6607	2,97 - 3,25 m	325	119929		19,100	1 PC / 10 PC
6608	3,22 - 3,50 m	350	119930		20,500	1 PC / 10 PC
6609	3,47 - 3,75 m	375	119931		21,900	1 PC / 10 PC
6610	3,72 - 4,00 m	400	119933		23,300	1 PC / 10 PC

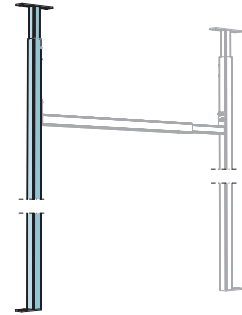

Telescopic support 75 x 50 x 4 mm

For mounting heavy doors, fire doors, radiators and heavy duty equipment.

Material thickness (mm): 4 mm
Material: Galvanised steel

Item number	Description	Length (cm)	Order number	Width (mm)	Weight (kg/m/pc)	Package/ Large pack
6615	2,47 - 2,75 m	275	119937		20,400	1 PC / 10 PC
6616	2,72 - 3,00 m	300	119938		22,200	1 PC / 10 PC
6617	2,97 - 3,25 m	325	119939		23,900	1 PC / 10 PC
6618	3,22 - 3,50 m	350	119940		25,800	1 PC / 10 PC
6619	3,47 - 3,75 m	375	119941		27,400	1 PC / 10 PC
6620	3,72 - 4,00 m	400	119943		29,200	1 PC / 10 PC

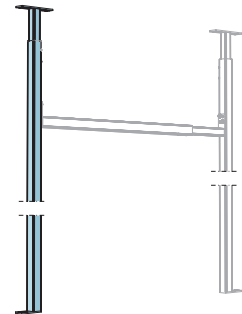

Telescopic support 100 x 50 x 4 mm

For mounting heavy doors, fire doors, radiators and heavy duty equipment.

Material thickness (mm): 4 mm
Material: Galvanised steel

Item number	Description	Length (cm)	Order number	Width (mm)	Weight (kg/m/pc)	Package/ Large pack
6625	2,47 - 2,75 m	275	119899		24,700	1 PC / 10 PC
6626	2,72 - 3,00 m	300	119901		26,800	1 PC / 10 PC
6627	2,97 - 3,25 m	325	119902		29,000	1 PC / 10 PC
6628	3,22 - 3,50 m	350	119903		31,100	1 PC / 10 PC
6629	3,47 - 3,75 m	375	119904		33,300	1 PC / 10 PC
6630	3,72 - 4,00 m	400	119905		35,500	1 PC / 10 PC

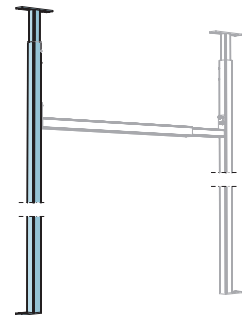

Telescopic support 100 x 100 x 4 mm

For mounting heavy doors, fire doors, radiators and heavy duty equipment.

Material thickness (mm): 4 mm
Material: Galvanised steel

Item number	Description	Length (cm)	Order number	Width (mm)	Weight (kg/m/pc)	Package/ Large pack
6591	3,01 - 3,25	325	119892		40,800	1 PC / 10 PC
6593	3,51 - 3,75	375	119893		46,700	1 PC / 10 PC
6595	4,01 - 4,25	425	119894		52,600	1 PC / 10 PC

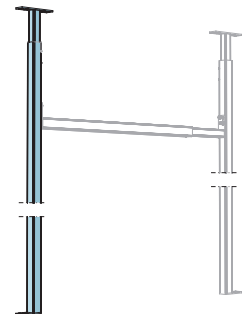

SUPPORTS AND DOOR SYSTEMS PASSAGIO

SUPPORTS AND DOOR SYSTEMS PASSAGIO

Telescopic lintel 50 x 50 x 4 mm

For mounting heavy doors, fire doors, radiators and heavy duty equipment.

Material thickness (mm): 4 mm
Material: Galvanised steel

Item number	Description	Length (cm)	Order number	Width (mm)	Weight (kg/m/pc)	Package/ Large pack
6645	0,76 - 1,00 m	100	119908		7,400	1 PC / 10 PC
6646	1,01 - 1,25 m	125	119909		8,800	1 PC / 10 PC
6647	1,26 - 1,50 m	150	119910		10,200	1 PC / 10 PC

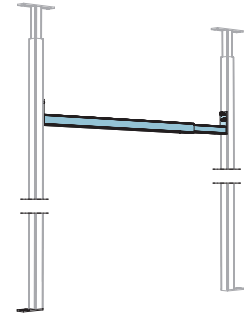

Telescopic lintel 75 x 50 x 4 mm

For mounting heavy doors, fire doors, radiators and heavy duty equipment.

Material thickness (mm): 4 mm
Material: Galvanised steel

Item number	Description	Length (cm)	Order number	Width (mm)	Weight (kg/m/pc)	Package/ Large pack
6655	0,76 - 1,00 m	100	119911		8,300	1 PC / 10 PC
6656	1,01 - 1,25 m	125	119913		10,100	1 PC / 10 PC
6657	1,26 - 1,50 m	150	119914		11,800	1 PC / 10 PC

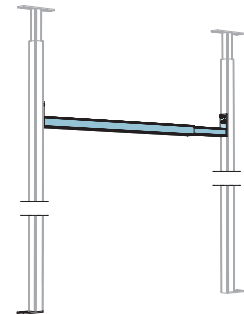

Telescopic lintel 100 x 50 x 4 mm

For mounting heavy doors, fire doors, radiators and heavy duty equipment.

Material thickness (mm): 4 mm
Material: Galvanised steel

Item number	Description	Length (cm)	Order number	Width (mm)	Weight (kg/m/pc)	Package/ Large pack
6665	0,76 - 1,00 m	100	119915		9,900	1 PC / 10 PC
6666	1,01 - 1,25 m	125	119916		12,100	1 PC / 10 PC
6667	1,26 - 1,50 m	150	119918		14,200	1 PC / 10 PC

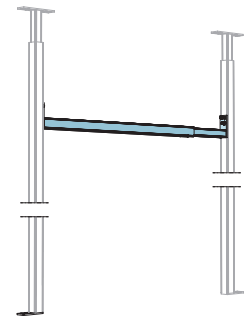

Door frame profile

Application area: walls, profiles pre-stamped to DIN standard unfinished construction dimensions.

Material: Galvanised steel
Material thickness (mm): 0,6 mm
Norm: EN 14195

Item number	Description	Length (cm)	Order number	Width (mm)	Weight (kg/m/pc)	Package/ Large pack
5261	U 50-06	130	100983	50	0,800	1 PC / 100 PC
5262	U 75-06	130	100984	75	0,950	1 PC / 100 PC
5263	U 100-06	130	100985	100	1,100	1 PC / 100 PC

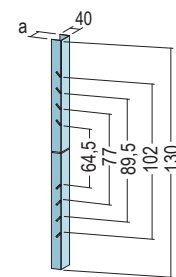

Telescopic lintel 100 x 100 x 4 mm

For mounting heavy doors, fire doors, radiators and heavy duty equipment.

Material thickness (mm): 4 mm
Material: Galvanised steel

Item number	Description	Length (cm)	Order number	Width (mm)	Weight (kg/m/pc)	Package/ Large pack
6598	0,76 - 1,00	100	119895		15,200	1 PC / 10 PC
6599	1,01 - 1,25	100	119900		18,200	1 PC / 10 PC
6602	1,76 - 2,01	100	119912		27,100	1 PC / 10 PC

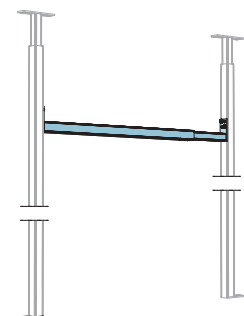

SUPPORTS AND DOOR SYSTEMS PASSAGIO

SUPPORTS AND DOOR SYSTEMS PASSAGIO

CA door support profile

Application area for the connection of heavy doors in drylining walls

Material thickness (mm): 2 mm
Material: S320 GD + ZM



Item number	Description	Length (cm)	Order number	Width (mm)	Weight (kg/m/pc)	Package/ Large pack
NEW 4850	CA 48,8 - 50 - 20	300	119362		2,440	1 PCS / 100 BUN
NEW	CA 48,8 - 50 - 20	400	119363		2,440	1 PCS / 100 BUN
NEW 4851	CA 73,8 - 50 - 20	300	119365		2,810	1 PCS / 100 BUN
NEW	CA 73,8 - 50 - 20	400	119366		2,810	1 PCS / 100 BUN
NEW 4852	CA 98,8 - 50 - 20	300	119367		3,210	1 PCS / 100 BUN
NEW	CA 98,8 - 50 - 20	400	119368		3,210	1 PCS / 100 BUN

CA Connection bracket set

For fixing CA profiles to the floor and ceiling.
Consisting of:
2 x connection bracket
4 x mounting set

Material thickness (mm): 3 mm
Material: S320 GD + ZM

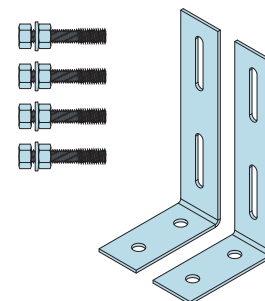

Item number	Description	Length (cm)	Order number	Width (mm)	Weight (kg/m/pc)	Package/ Large pack
NEW 4536	pour CA 50	0	119371			1 PC / 100 PC
NEW 4537	for CA 75	0	119372			1 PC / 100 PC
NEW 4538	CA 100	0	119373			1 PC / 100 PC

C-parapet/apron profile

Material thickness (mm): 2 mm
Material: S320 GD + ZM

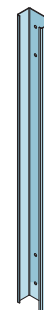

Item number	Description	Length (cm)	Order number	Width (mm)	Weight (kg/m/pc)	Package/ Large pack
4859	C-BS 75-50-20	100	119954		3,250	1 PC / 252 BUN
NEW 4862	C-BS 100-50-20	100	119338		3,250	1 PC / 252 BUN
NEW 4863	C-BS 100-50-20	120	119339		3,900	1 PC / 210 BUN
4864	C-BS 100-50-20	150	119515		3,900	1 PC / 210 BUN

Mounting bracket

Mounting bracket for attaching C-BS profiles to parapets or ceiling aprons

Material thickness (mm): 5 mm
Material: S320 GD + ZM

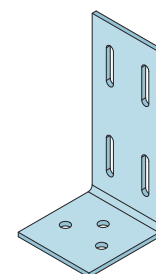

Item number	Description	Length (cm)	Order number	Width (mm)	Weight (kg/m/pc)	Package/ Large pack
NEW 4535	BS LW 200x100x90x5	0	119328		0,950	1 PC / 25 PC



PASSAGIO SLIDING DOOR ELEMENT FOR THREE WIDTHS AND TWO HEIGHTS

Our passagio sliding door element is completely made of galvanised steel and is suitable for installation with wooden frames.

The details and technical solutions make the difference in terms of functionality and performance, both during installation and when using the sliding door.

Easy to install

Thanks to the passagio sliding door element, the assembly and installation steps of the sliding door are very fast and flexible.

Small size, maximum results

Thanks to a system that optimises storage, up to 6 standard sizes can be installed with just one product.

 **passagio**
SUPPORTS AND DOOR SYSTEMS

Product video
View now »

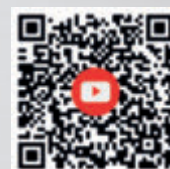

SUPPORTS AND DOOR SYSTEMS PASSAGIO

SUPPORTS AND DOOR SYSTEMS PASSAGIO

Sliding door element Installation set

Sliding door element for wooden frames. Suitable for three door widths: 610 mm, 735 mm and 860 mm and two door heights: 1985 mm and 2110 mm. Removable running track, with damping on both sides as standard. Guides on the installation element for direct installation in the drywall. Maximum door leaf thickness: 42 mm. Suitable for doors up to 80 kg.

Material: Galvanised steel



Item number	Description	Length (cm)	Order number	Width (mm)	Weight (kg/m/pc)	Package/ Large pack
6400	C 75 wall thickness 100/125	225	115798		0,000	1 PC / 25 PC

Connecting element for double sliding doors

Connecting element for connecting two sliding door elements article 6400 for making a double door. For door widths 610+610 mm, 735 + 735 mm and 860 + 860 mm.

Material: Galvanised steel

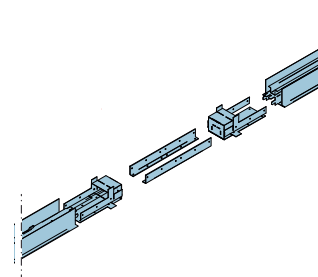

Item number	Description	Length (cm)	Order number	Width (mm)	Weight (kg/m/pc)	Package/ Large pack
6401	for article 6400	34	115799		0,000	1 PC / 25 PC

Extension set for special heights sliding doors

Extension kit for sliding door element article 6400, for door leaf heights up to 2700 mm. Extension of height in 5 cm steps. Pre-punched extension profiles and additional cross braces.

Material: Galvanised steel

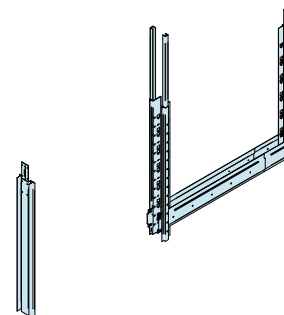

Item number	Description	Length (cm)	Order number	Width (mm)	Weight (kg/m/pc)	Package/ Large pack
6402	for article 6400	120	115800		0,000	1 PC / 25 PC

Extension set for sliding glass doors

Extension set for article 6400. Clamp (2 pieces) especially for glass doors. Suitable for glass doors up to 80 kg.

Material:

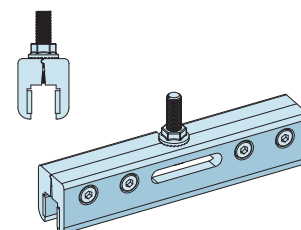

Item number	Description	Length (cm)	Order number	Width (mm)	Weight (kg/m/pc)	Package/ Large pack
6403	for article 6400	40	115801		0,000	1 PC / 25 PC

PASSAGIO SLIDING DOOR ELEMENT

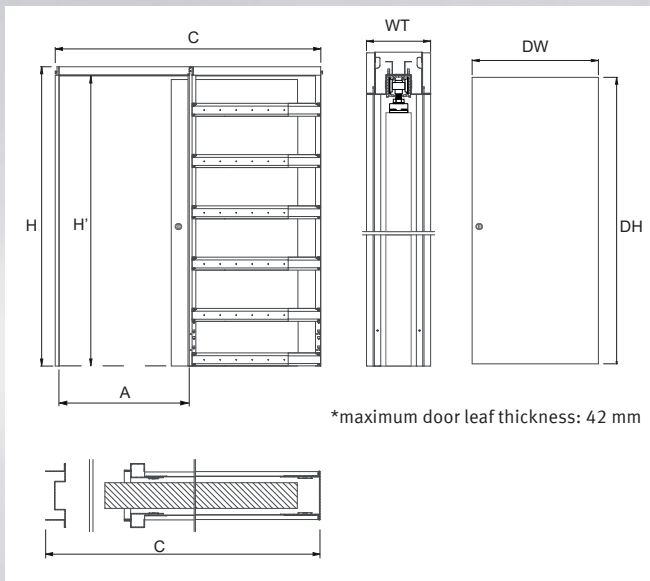

TECHNICAL DATA - Ref.No. 6400			
DW x DH door leaf- dimensions	C x H Item - dimensions	A x H' Passage dimensions	WT Finished wall thickness
610 x 1985 mm	1569 x 2085 mm	640 x 2015 mm	100/125 mm
610 x 2110 mm	1569 x 2210 mm	640 x 2140 mm	100/125 mm
735 x 1985 mm	1569 x 2085 mm	765 x 2015 mm	100/125 mm
735 x 2110 mm	1569 x 2210 mm	765 x 2140 mm	100/125 mm
860 x 1985 mm	1819 x 2085 mm	890 x 2015 mm	100/125 mm
860 x 2110 mm	1819 x 2210 mm	890 x 2140 mm	100/125 mm

PASSAGIO CONNECTING ELEMENT FOR DOUBLE SLIDING DOORS

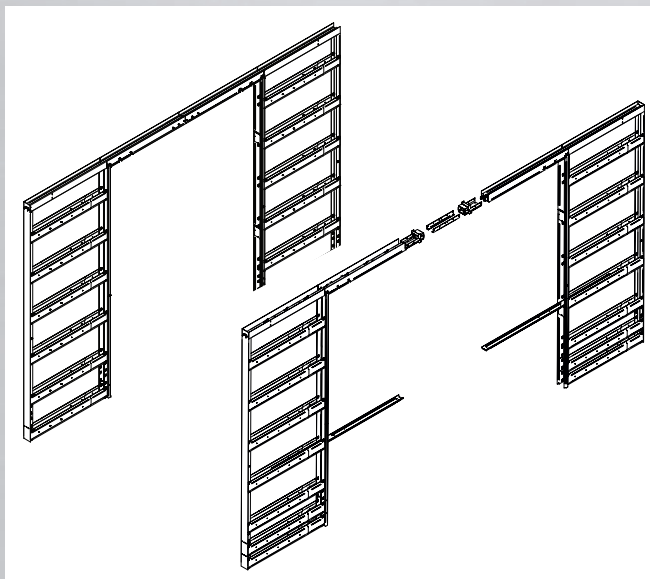

TECHNICAL DATA - Ref.No. 6401 IN CONJUNCTION WITH 6400			
DW x DH door leaf- dimensions	C x H Item - dimensions	A x H' Passage dimensions	WT Finished Wall thickness
610+610 x 1985 mm	3035 x 2085 mm	1230 x 2015 mm	100/125 mm
610+610 x 2110 mm	3035 x 2210 mm	1230 x 2140 mm	100/125 mm
735+735 x 1985 mm	3035 x 2085 mm	1480 x 2015 mm	100/125 mm
735+735 x 2110 mm	3035 x 2210 mm	1480 x 2140 mm	100/125 mm
860+860 x 1985 mm	3535 x 2085 mm	1730 x 2015 mm	100/125 mm
860+860 x 2110 mm	3535 x 2210 mm	1730 x 2140 mm	100/125 mm

PASSAGIO EXTENSION SET FOR SPECIAL HEIGHTS OF SLIDING DOOR ELEMENT

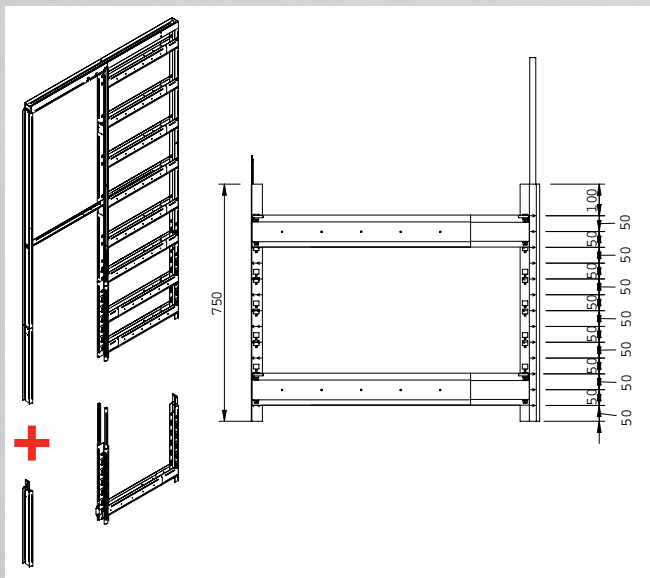

TECHNICAL DATA - Ref.No. 6402 IN CONJUNCTION WITH 6400			
DH door leaf- dimensions	H Item - dimensions	H' Pass-through height	WT Finished Wall thickness
2210 mm	2310 mm	2240 mm	100/125 mm
2260 mm	2360 mm	2290 mm	100/125 mm
2310 mm	2410 mm	2340 mm	100/125 mm
2360 mm	2460 mm	2390 mm	100/125 mm
2410 mm	2510mm	2440 mm	100/125 mm
2460 mm	2560 mm	2490 mm	100/125 mm
2510 mm	2610 mm	2540 mm	100/125 mm
2560 mm	2660 mm	2590 mm	100/125 mm
2610 mm	2710 mm	2640 mm	100/125 mm
2660 mm	2760 mm	2690 mm	100/125 mm
2710 mm	2810 mm	2740 mm	100/125 mm
2760 mm	2860 mm	2790 mm	100/125 mm



DRY LINING



LUMINO – LED-LIGHTNING DESIGN

The new PROTEKTOR product LUMINO brings the right light for extraordinary lightning concepts. Wherever you need unusual accents in room design the aluminium profiles provide a special atmosphere. Whether as an LED profile or magnetic LED strip for fixing to metal surfaces, Lumino lets your professional drywall projects shine in modern light.



Product video
View now »

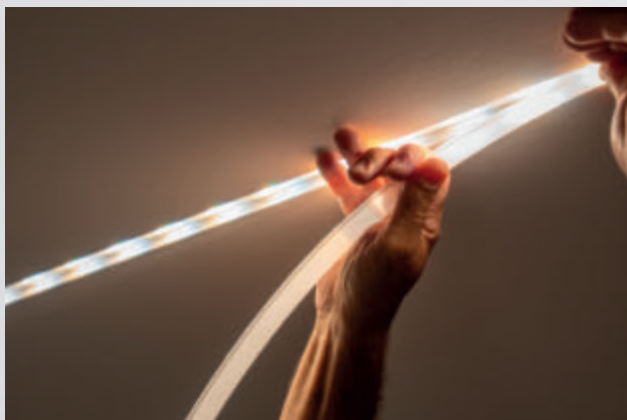

LED-LIGHTNING DESIGN LUMINO

PRODUCT CLASS 6660

LED cove profile white

Vouten profile with opal plastic cover for LED strips.
Suitable for LED strips with max. width 10 mm and max. 20 Watt/m.
LED rail without LED strips.
For panel thickness 12.5 mm

Material: Aluminum, white coated
Material thickness (mm): 1 mm
Notes:
The surface of the profiles (anodised or powder-coated) may show small scratches, press marks and discolouration due to the pressing process and mechanical processing. This does not constitute reasons for complaint.

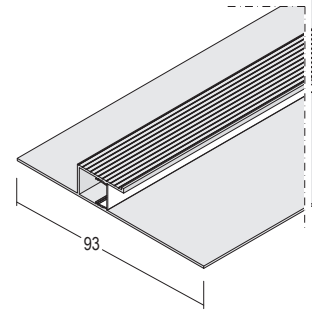

NEW

Item number	Description	Length (cm)	Order number	Width (mm)	Weight (kg/m/pc)	Package/ Large pack
6524	2000 mm	200	119114		0,806	4 PC / 400 BOX

Plasterboard 12,5 mm with aluminium LED profile 15 mm

Straight plasterboard strips with integrated aluminium profile incl. opal plastic cover to accommodate LED strips. For LED strips with a width of up to 13 mm. Light sources are not included in the scope of delivery.

Material: Plasterboard with aluminium



Item number	Description	Length (cm)	Order number	Width (mm)	Weight (kg/m/pc)	Package/ Large pack
6500	2000 x 145 mm	200	119048		2,660	5 PC / 20 BOX

Corner Plasterboard 12,5 mm with aluminium LED profile 15 mm

Plasterboard corner junction with integrated aluminium profile incl. opal plastic cover to accommodate LED strips. For LED strips with a width of up to 13 mm. Light sources are not included in the scope of delivery.

Material: Plasterboard with aluminium



Item number	Description	Length (cm)	Order number	Width (mm)	Weight (kg/m/pc)	Package/ Large pack
6501	290 mm x 145 mm	0	119049		0,580	10 PC / 80 BOX

LED render stop profile

Connecting and end profile with opal plastic cover for LED strips.
Suitable for LED strips with max. width 14 mm and max. 15 Watt/m.
LED rail without LED strips.
For panel thickness 12.5 mm

Material: Aluminum
Material thickness (mm): 1 mm
Notes:
The surface of the profiles (anodised or powder-coated) may show small scratches, press marks and discolouration due to the pressing process and mechanical processing. This does not constitute reasons for complaint.

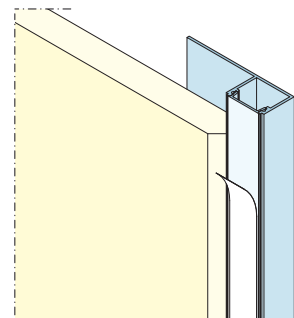

Item number	Description	Length (cm)	Order number	Width (mm)	Weight (kg/m/pc)	Package/ Large pack
6522	2000 mm	200	118335		0,446	4 PC / 100 BOX

LED-LIGHTNING DESIGN LUMINO

PRODUCT CLASS 6660

LED surface profile

Connection profile with opal plastic cover on both sides for LED strips.
 Suitable for LED strips with max. width 14 mm and max. 15 Watt/m.
 LED rail without LED strips.

Material: Aluminum

Material thickness (mm): 1 mm

Notes:

The surface of the profiles (anodised or powder-coated) may show small scratches, press marks and discolouration due to the pressing process and mechanical processing. This does not constitute reasons for complaint.

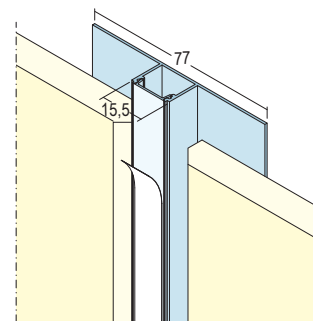

Item number	Description	Length (cm)	Order number	Width (mm)	Weight (kg/m/pc)	Package/ Large pack
6523	2000 mm	200	118336		0,688	4 PC / 100 BOX

LED surface profile wide

Connection profile on both sides with opal plastic cover for LED strips.
 Suitable for LED strips with a maximum width of 20 mm and a maximum of 20 watts/m.
 LED track without LED strips.
 For plate thickness 12.5 mm
 Can be used as main lighting in conjunction with a 20 watt LED strip.

Material: Aluminum

Material thickness (mm): 1 mm

Notes:

The profiles (anodized or powder-coated) may have small scratches, press marks and discoloration on the surface due to the pressing process and mechanical processing. This does not constitute a reason for a complaint.

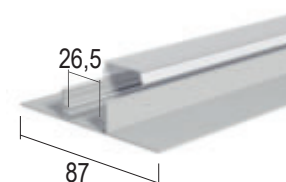

Item number	Description	Length (cm)	Order number	Width (mm)	Weight (kg/m/pc)	Package/ Large pack
6533	2000 mm	200	119865		0,688	4 PC / 100 BOX

LED internal corner profile

Internal corner profile with opal plastic cover for LED strips.
 Suitable for LED strips with max. width 14 mm and max. 15 watts/m.
 LED profile without LED strips
 For panel thickness 12.5 mm

Material: Aluminum

Material thickness (mm): 1 mm

Notes:

The surface of the profiles (anodised or powder-coated) may show small scratches, press marks and discoloration due to the pressing process and mechanical processing. This does not constitute reasons for complaint.

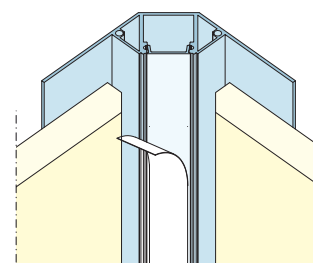

Item number	Description	Length (cm)	Order number	Width (mm)	Weight (kg/m/pc)	Package/ Large pack
6542	2000 mm	200	118337		1,220	4 PC / 100 BOX

LED External corner profile

External corner profile with opal plastic cover for LED strips.
 Suitable for LED strips with max. width 14 mm and max. 15 watts/m.
 LED profile without LED strips
 For panel thickness 12.5 mm

Material: Aluminum

Material thickness (mm): 1 mm

Notes:

The surface of the profiles (anodised or powder-coated) may show small scratches, press marks and discoloration due to the pressing process and mechanical processing. This does not constitute reasons for complaint.

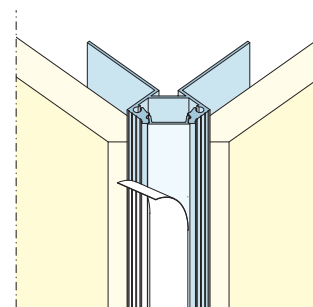

Item number	Description	Length (cm)	Order number	Width (mm)	Weight (kg/m/pc)	Package/ Large pack
6543	2000 mm	200	118338		0,720	4 PC / 100 BOX

LED-LIGHTNING DESIGN LUMINO

PRODUCT CLASS 6660

LED Protective tube black

Prevents the penetration of filler.
Reusable.

Material: PVC



Item number	Description	Length (cm)	Order number	Width (mm)	Weight (kg/m/pc)	Package/ Large pack
6547	5000 mm	500	118342		0,430	1 PC / 100 BOX

LED Protective tube wide black

Prevents the penetration of filler.
Reusable.

Material: PVC



Item number	Description	Length (cm)	Order number	Width (mm)	Weight (kg/m/pc)	Package/ Large pack
6534	5000 mm	500	119866		0,430	1 PC / 100 BOX

Opal plastic cover

Opal cover as a spare part.
The profiles are already fitted with the opal cover.

Material:



Item number	Description	Length (cm)	Order number	Width (mm)	Weight (kg/m/pc)	Package/ Large pack
6546	2000 mm	200	119320		0,060	4 PC / 400 BOX

LED alu-ceiling rail sunset

For creating shadow joints. Suitable for LED strips with max. width 18 mm and max. 30 watts/m. LED profile Lumino without LED strip. For panel thickness 12.5 mm.

Material: Aluminum

Material thickness (mm): 1,5 mm

Notes:

The surface of the profiles (anodised or powder-coated) may show small scratches, press marks and discolouration due to the pressing process and mechanical processing. This does not constitute reasons for complaint.

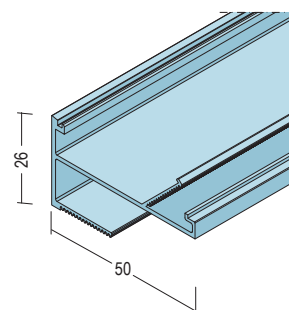

Item number	Description	Length (cm)	Order number	Width (mm)	Weight (kg/m/pc)	Package/ Large pack
6518	2000 mm	200	118332		0,784	4 PC / 100 BOX

LED-LIGHTNING DESIGN LUMINO

PRODUCT CLASS 6660

LED alu-ceiling rail sunrise

For creating a shadow joint.
Suitable for LED strips with max. width 12 mm and max. 30 watts/m. LED track Lumino without LED strip. For panel thickness 12.5 mm.

Material: Aluminum
Material thickness (mm): 1,5 mm

Notes:
The surface of the profiles (anodised or powder-coated) may show small scratches, press marks and discolouration due to the pressing process and mechanical processing. This does not constitute reasons for complaint.

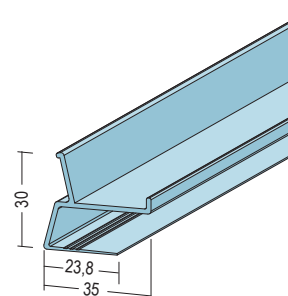

Item number	Description	Length (cm)	Order number	Width (mm)	Weight (kg/m/pc)	Package/ Large pack
6538	2000 mm	200	118334		0,588	4 PC / 100 BOX

LED alu-ceiling rail sunset white

For creating shadow joints. Suitable for LED strips with max. width 18 mm and max. 30 watts/m. LED profile Lumino without LED strip. For panel thickness 12.5 mm.

Material: Aluminum, white coated
Material thickness (mm): 1,5 mm

Notes:
similar RAL 9010

The surface of the profiles (anodised or powder-coated) may show small scratches, press marks and discolouration due to the pressing process and mechanical processing. This does not constitute reasons for complaint.

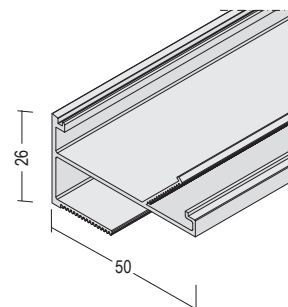

Item number	Description	Length (cm)	Order number	Width (mm)	Weight (kg/m/pc)	Package/ Large pack
6519	2000 mm	200	118331		0,784	4 PC / 100 BOX

LED alu-ceiling rail sunrise white

For creating a shadow gap.
Suitable for LED strips with max. width 12 mm and max. 30 watts/m. LED track Lumino without LED strip. For panel thickness 12.5 mm.

Material: Aluminum, white coated
Notes:
similar RAL 9010

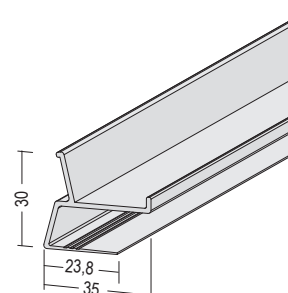

Item number	Description	Length (cm)	Order number	Width (mm)	Weight (kg/m/pc)	Package/ Large pack
6541	1500 mm	150	117264		0,450	4 PC / 50 BOX
6539	2000 mm	200	118333		0,588	4 PC / 100 BOX

LED light strip set Sunline

4 x 1000 mm x 18 mm x 7 mm
With magnetic strip for quick fastening.
2835 LED 24V Strip IP43, 1200 Lm, max. 10 Watt, EEF: A++CRI:>80, incl. 2-m connection cable and plugs, CE & RoHS
incl. LED power cable all plug adapters

Material:
Notes:
WEEE-Reg.-No. DE 93452812
Cannot be combined with LED profile SUNRISE resp. SUNSET



Item number	Description	Length (cm)	Order number	Width (mm)	Weight (kg/m/pc)	Package/ Large pack
6525	3000K (warm-white)	100	114424		1,000	1 PC / 60 BOX
6526	4000K (white)	100	114425		1,000	1 PC / 60 BOX

LED-LIGHTNING DESIGN LUMINO

PRODUCT CLASS 6660

LED light strip set Sunline dimmable

4 x 1000 mm x 18 mm x 7 mm
 With magnetic strip for quick fastening.
 2835 LED 24V Strip IP43, 1200 Lm, max. 10 Watt,
 EEF: A++CRI:>80, incl. 2-m connection cables and
 plugs, CE & RoHS
 incl. LED power cable, remote control
 and dimmer controller, and all plug
 adapters

Material:
Notes:
 WEEE-Reg.-No. DE 93452812
 Cannot be combined with LED profile SUNRISE
 resp. SUNSET



Item number	Description	Length (cm)	Order number	Width (mm)	Weight (kg/m/pc)	Package/ Large pack
6531	4000K (white)	100	114427		1,000	1 PC / 60 BOX



MADE TO FIT YOUR NEEDS

The right tool makes all the difference. With PROTEKTOR profile cutters you can always cut profiles to the right length and to suit the job, with the right angle, precisely, safely and correctly. Blade and cutting block are both made from quality alloy, tempered special steel. Both the material and the way it is processed provide the basis for a long life in daily use. Quality tongs for crimping profiles, and other high-quality accessories for edging and punching tools complete the product range.

Product video
View now »



TOOLS

PRODUCT CLASS 6620

MAXI Profile cutter without accessories

For cutting UW, CW, (50, 75 and 100) CD and UD profiles with a sheet metal thickness of up to 0.7 mm.

Material:



Item number	Description	Order number	Width (mm)	Weight (kg/m/pc)	Package/ Large pack
6432	for U, C, CD, UD	101793		14,000	1 PC / 10 PC

Replacement blade

Item number	Description	Order number	Width (mm)	Weight (kg/m/pc)	Package/ Large pack
6427	for 6432	101785		0,500	1 PC / 10 PC
6429	∅ 25mm	101796		1,000	1 PC / 10 PC
6430	∅ 6.2mm	101797		0,250	1 PC / 10 PC
6431	Length stop	101800		0,200	1 PC / 10 PC



Profile shear

Special cutter with a premarked template for ensuring precise cutting of PVC profiles at a right angle.



Item number	Plaster thickness (mm)	Length (cm)	Order number	Material	Package/ Large pack
1452		26	102376		50 PC / 16 BOX



FACADE-/VENTILATION PROFILES

PROTEKTOR facade and ventilation profiles stand for design and quality that is recognisable and manufactured in Germany.

GENERAL NOTES REGARDING THE INSTALLATION OF FACADE-/VENTILATION PROFILES

The guidelines of board and substructure manufacturers as well as all applicable requirements, standards and directives must be taken into consideration and observed when selecting and installing the facade-/ventilation profiles.

Like all products, materials and building materials, facade profiles face thermal expansion in the building. The temperature limits of -20 °C and +80 °C according to DIN 18516-1 must be taken into account.

Additionally, take the installation temperature into consideration and maintain the necessary distances at profile joints. Like most components of rear-ventilated curtain walls, the facade profiles must not be constrained. Always allow for linear expansion in the profiles.

Example: At a temperature difference of 50 °K, the linear expansion of hard PVC profiles is approx. 3.8 mm per metre.

For Aluminium profiles, the linear expansion is approx. 1.2 mm per metre for the same temperature difference.

The facade profiles should generally be shortened to the length or width of the board for installation and ideally the storey height should not be exceeded.

Keep profiles from overlapping. This can be achieved by constructive measures such as notching or mitred profiles.

Please observe the notes relating to the relevant profile applications. The following details are examples. **All PROTEKTOR plastic facade-/ventilation profiles must be installed in a pressure-free and tension-free manner.**

Physical and thermal properties of Aluminium profiles			
Properties	Unit	Test method	Values
Coefficient of linear expansion	K ⁻¹ /m	Leitz-Dilatometer	24 x 10 ⁻⁶

Physical and thermal properties of plastic profiles made of highly impact resistant hard PVC			
Properties	Unit	Test method	Values
Tensile strength	N/mm ²	DIN 53455	48
Elongation	%	DIN 53455	35
Impact resistance	KJ/m ²	DIN 53453	
at +21 °C	KJ/m ²	(short standard rod)	without break
at 0 °C	KJ/m ²	(short standard rod)	without break
at -20 °C	KJ/m ²	(short standard rod)	without break
Notched impact strength at +21 °C	KJ/m ²	DIN 53448	36,0
Notched impact strength at bei 0 °C	KJ/m ²	DIN 53448	7,5
Brinell hardness after 10 and 60 seconds	N/mm ²	DIN 53456	102,7/93,7
Density	g/cm ³	DIN 53479	1.48
Modulus of elasticity	N/mm ²	DIN 53457	2.500
Water absorption after 96 hours	%	DIN 53495	≤ 0,06
Dimensional stability Vicat B	°C	DIN 53460	80
Coefficient of linear expansion	K ⁻¹ /m	Leitz dilatometer	76 x 10 ⁻⁶

MATERIALS, COLOURS

PROTEKTOR Aluminium and PVC facade-/ventilation profiles are manufactured according to the applicable standards. EPDM stands for Ethylene Propylene Diene Monomer, which is a synthetic rubber with exceptional properties. All PROTEKTOR plastic facade profiles are made without lead stabilisers!

PROTEKTOR PVC facade profiles are manufactured in the following standard colours (due to the printing process, the colours depicted here may appear different than the originals).

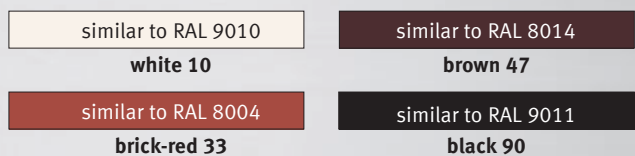

LIGHT AND WEATHER DURABILITY, FIRE BEHAVIOUR

Our PROTEKTOR hard PVC profiles achieve the highest possible light durability level (level 8) on the wool scale. The formula we have developed together with our suppliers, prevents the usage of waste or reclaimed materials in our products. In accordance with our General Sales terms and conditions (section 6), we provide a guarantee of 5 years for the technical functionality of the facade profiles.

In DIN 4102 Part 4, the polyvinyl chloride (PVC-U), Hard-PVC, which is free of plasticisers, has been classified as building material class B1 – flame resistant – according to DIN 19531.

We accept no liability for any printing errors or other changes. Subject to change. Previous cat logues are hereby rendered invalid.

FACADE PROFILES OVERVIEW

ALUMINIUM



ALUMINIUM PROFILES

Board thickness/structure	Board manufacturer/type	Corner profiles, exterior corners						Corner profile, inner corners	
6 mm	Eternit Trespa Fundermax Rockpanel FibreCem		9444 9445					9432	9436 9437
8 mm	Eternit Trespa Fundermax Rockpanel FibreCem	9440 9441	9446 9447					9432	9436 9437
10 mm	Eternit Trespa Fundermax Rockpanel FibreCem	9442 9443	9448 9449	9080		9430		9432	9436 9437
12 mm	Eternit Eternit Cedral Click** Trespa Fundermax Rockpanel FibreCem	9460 9461		9080**		9430		9432**	9436 9437
13 mm bis 20 mm	Corrugated profiles Trapezoidal profiles Weatherboarding Timber slats			9080 9402		9431	9439	9486*	9436 9437
21 mm bis 28 mm	Eternit-Cedral* Trapezoidal profiles Weatherboarding Timber slats			9484*	9485* matches 9451*	9428*	9438	9486*	9436 9437

Board thickness/structure	Board manufacturer/type	Vertical and horizontal joint profiles						Connecting and edge profiles			
6 mm	Eternit Trespa Fundermax Rockpanel FibreCem	9048 9061 9086		9042 9053 9054	9736	9311		9081			
8 mm	Eternit Trespa Fundermax Rockpanel FibreCem	9049 9062 9087	9092	9042 9053 9054	9738	9311		9081	9450		9085
10 mm	Eternit Trespa Fundermax Rockpanel FibreCem	9088	9092	9042 9053 9054		9311		9081	9451		9090
12 mm	Eternit Eternit Cedral Click** Trespa Fundermax Rockpanel FibreCem	9089	9092	9042 9053 9054		9311		9081	9407 9483**	9426**	
13 mm bis 20 mm	Corrugated profiles Trapezoidal profiles Weatherboarding Timber slats						9027		9408 9409		
21 mm bis 28 mm	Eternit-Cedral* Trapezoidal profiles Weatherboarding Timber slats						9027		9483* 9451* for board- strips 10 mm	9487*	

Notes: Some Protektor facade profiles are also suitable for the following manufacturers: Alucobond, Agrob Buchtal, Marazzi, Creaton, Argeton, Möding, Maas, Resopal, Prodema etc.; Facade profiles can be powder coated in RAL and in whole packaging units;

For reference photos featuring Protektor facade profiles,

see http://protektor.com/de/downloads/technische-unterlagen/fassadenprofile/produktvorstellung/Eigenschaften_von_Fassadenprofilen (available in German only);

* Profiles for Eternit-Cedral boards





** Profiles for Eternit-Cedral Clicks boards





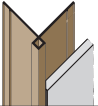

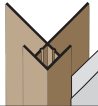
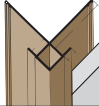

FACADE PROFILES OVERVIEW

PVC

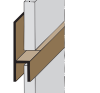

PVC PROFILES

Board thickness/structure	Board manufacturer/type	Corner profiles, exterior corners					
							
6 mm	Eternit Trespa Fundermax Rockpanel FibreCem	3569					
8 mm	Eternit Trespa Fundermax Rockpanel FibreCem	3623		3674			
10 mm	Eternit Trespa Fundermax Rockpanel FibreCem	3623		3674	3624		
12 mm	Eternit Trespa Fundermax Rockpanel FibreCem	3623		3674		3504	
13 mm bis 20 mm	Wellprofile Trapezprofile Stülpchalungen Holzlamellen		3506			3504 3555	3501
21 mm bis 28 mm	Trapezprofile Stülpchalungen Holzlamellen					3590	

Board thickness/structure	Board manufacturer/type	Corner profile, inner corners		Vertical and horizontal joint profiles					
									
6 mm	Eternit Trespa Fundermax Rockpanel FibreCem	3505	3528 3540	3534		3557 3558		3691	
8 mm	Eternit Trespa Fundermax Rockpanel FibreCem	3505	3528 3540	3535		3546		3658	3588
10 mm	Eternit Trespa Fundermax Rockpanel FibreCem	3505	3528 3540	3536		3547		3609	
12 mm	Eternit Trespa Fundermax Rockpanel FibreCem	3505	3528 3540	3537		3548		3563	3589
13 mm bis 20 mm	Corrugated profiles Trapezoidal profiles Weatherboarding Timber slats	3505	3528 3540		3554		3560 3561	3529 3502	
21 mm bis 28 mm	Trapezoidal profiles Weatherboarding Timber slats		3528 3540					3527	

Notes: Some Protektor facade profiles are also suitable for the following manufacturers: Alucobond, Agrob Buchtal, Marazzi, Creaton, Argeton, Möding, Maas, Resopal, Prodema etc.; For reference photos featuring Protektor facade profiles, see http://protektor.com/de/downloads/technische-unterlagen/fassadenprofile/produkt-vorstellung/Eigenschaften_von_Fassadenprofilen (available in German only)

FACADE PROFILES CONNECTION STRUCTURE

CONNECTING PROFILES WITHOUT COVERED CUTTING EDGES



INSTRUCTIONS FOR APPLICATION

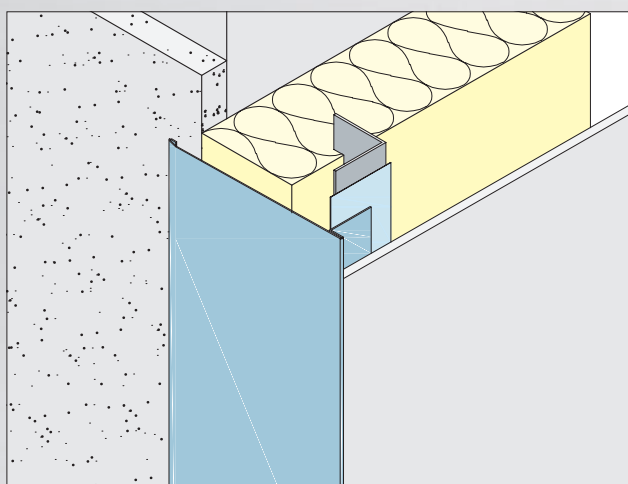

The connecting profiles connect the facade cladding and the different surfaces of the facade, such as the plaster, and thus facilitate a simple and precise transition. They fully cover and protect the cutting edges of the facade boards and cover the substructure on the side.

The connecting profiles may also be used for connections to windows and doors.

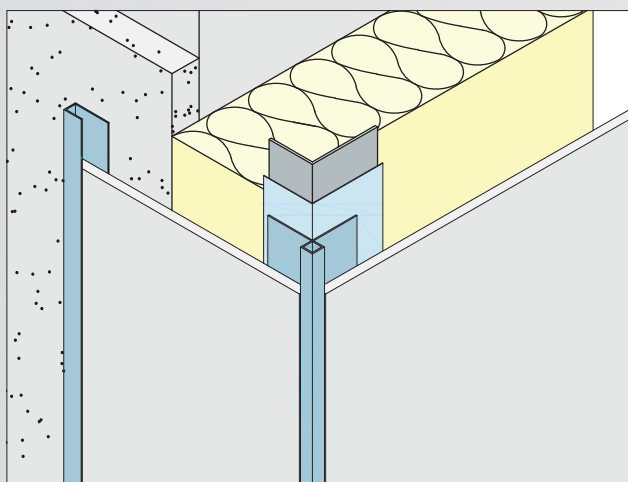

The connection of a curtain wall via a corner to another surface, for example a plastered surface or ETICS, can easily be carried out with an edge profile and a U-edge profile. For example, here with edge profile no. 9440 and U-edge profile no. 9450. Protektor has a large selection of façade profiles.

CORNER PROFILES

CORNER PROFILES WITHOUT COVERED CUTTING EDGES

Corner bead without covered cutting edge Alu

Edge profile for facade cladding 6.5 mm.
Please note the application instructions
and technical requirements.

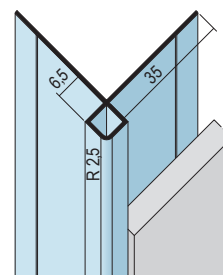

NEW

Item number	Material	Length (cm)	Order number	Color	Package/ Large pack
97018	Aluminum, anodized	300	118564	NA - natur	10 PCS / 70 BUN

Corner bead without covered cutting edge Alu

Corner profile for facade cladding of 8.5 mm.
Please observe the application instructions
and technical requirements.

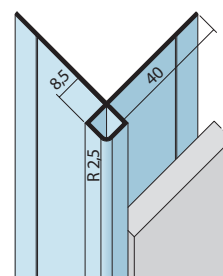

Item number	Material	Length (cm)	Order number	Color	Package/ Large pack
9440	Aluminum	300	108197	NA - natur	10 PCS / 70 BUN
9441	Aluminum	300	108198	EV - E6 EV1	10 PCS / 70 BUN

Corner bead without covered cutting edge Alu

Corner profile for facade cladding 10.8 mm.
Please observe the application instructions
and technical requirements.

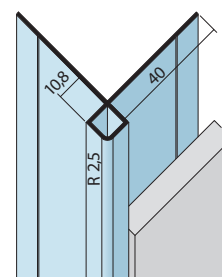

Item number	Material	Length (cm)	Order number	Color	Package/ Large pack
9442	Aluminum	300	108199	NA - natur	10 PCS / 33 BUN
9443	Aluminum	300	108200	EV - E6 EV1	10 PCS / 33 BUN

Corner bead without covered cutting edge Alu

Corner profile for facade cladding 12.8 mm.
Please observe the application instructions
and technical requirements.

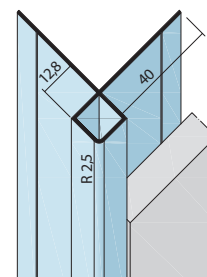

Item number	Material	Length (cm)	Order number	Color	Package/ Large pack
9460	Aluminum	300	108267	NA - natur	10 PCS / 70 BUN
9461	Aluminum	300	108268	EV - E6 EV1	10 PCS / 30 BUN

Corner bead without covered cutting edge Alu

Corner profile for facade cladding of 13.5 mm.
Please observe the application instructions
and technical requirements.

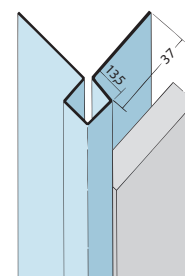

Item number	Material	Length (cm)	Order number	Color	Package/ Large pack
9080	Aluminum	250	101612	NA - natur	10 PCS / 35 BUN

CORNER PROFILES

CORNER PROFILES WITHOUT COVERED CUTTING EDGES

Corner bead without covered cutting edge Alu

Corner profile for façade cladding of 18 mm.
Please observe the application instructions
and technical requirements.

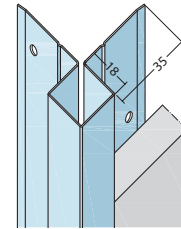

Item number	Material	Length (cm)	Order number	Color	Package/ Large pack
9402	Aluminum	250	103075	NA - natur	10 PCS / 31 BUN

Corner bead without covered cutting edge Alu

Corner profile for façade cladding 25 mm.
Please observe the application instructions
and technical requirements.

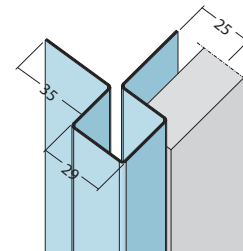

Item number	Material	Length (cm)	Order number	Color	Package/ Large pack
9484	Aluminum	300	109702	NA - natur	10 PCS / 20 BUN

Corner bead without covered cutting edge Alu

Corner profile for façade cladding of
25 or 10 mm.
Please observe the application instructions
and technical requirements.

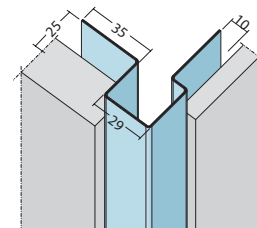

Item number	Material	Length (cm)	Order number	Color	Package/ Large pack
9485	Aluminum	300	109703	NA - natur	10 PCS / 20 BUN

Corner bead without covered cutting edge Alu

Edge and cross profiles for large-format façade
cladding of 12 mm.
Please observe the application instructions
and technical requirements.

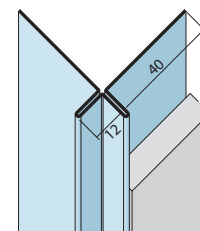

Item number	Material	Length (cm)	Order number	Color	Package/ Large pack
9430	Aluminum	250	108210	NA - natur	10 PCS / 32 BUN

Corner bead without covered cutting edge Alu

Corner and cross profiles for large-format façade
cladding, weather boarding, corrugated sheets,
etc. of 20 mm.
Please observe the application instructions
and technical requirements.

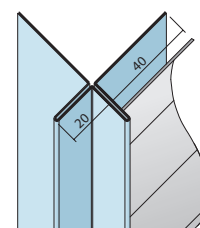

Item number	Material	Length (cm)	Order number	Color	Package/ Large pack
9431	Aluminum	250	108211	NA - natur	10 PCS / 24 BUN

CORNER PROFILES

CORNER PROFILES WITHOUT COVERED CUTTING EDGES

Corner bead without covered cutting edge Alu

Edge and cross profile for rhombus, wood lamella façades or any type of façade cladding of 28 mm. Please observe the application instructions and technical requirements.

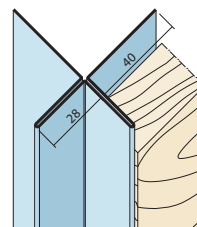

Item number	Material	Length (cm)	Order number	Color	Package/ Large pack
9428	Aluminum	250	109170	NA - natur	10 PCS / 18 BUN

Corner bead Y without covered cutting edge Alu

Y corner profile for rhombus, wood lamella façades or any other façade cladding of 22 mm. Please observe the application instructions and technical requirements.

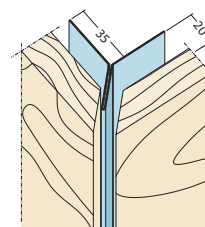

Item number	Material	Length (cm)	Order number	Color	Package/ Large pack
9439	Aluminum	250	109728	NA - natur	10 PCS / 30 BUN

Corner bead Y without covered cutting edge Alu

Y corner profile for rhombus, wood lamella façades or any type of façade cladding of 28 mm. Please observe the application instructions and technical requirements.

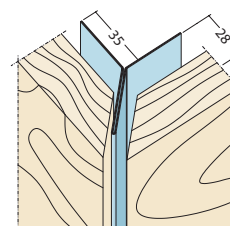

Item number	Material	Length (cm)	Order number	Color	Package/ Large pack
9438	Aluminum	250	109729	NA - natur	10 PCS / 20 BUN

Corner bead without covered cutting edge PVC

Corner profile for façade cladding of 6.5 mm.

Notes:
Attached PVC Clip-on profiles reduce the ingress of water.

Item number	Material	Length (cm)	Order number	Color	Package/ Large pack
3569	Hard PVC	300	100737	90 - black	10 PCS / 49 BUN
	Hard PVC	300	100733	10 - white	10 PCS / 49 BUN

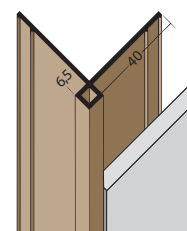

Corner bead without covered cutting edge PVC

Corner profile for façade cladding of 11 mm.

Notes:
Attached PVC Clip-on profiles reduce the ingress of water.

Item number	Material	Length (cm)	Order number	Color	Package/ Large pack
3623	Hard PVC	300	101299	90 - black	10 PCS / 30 BUN

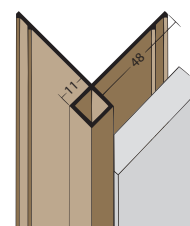

CORNER PROFILES

CORNER PROFILES WITHOUT COVERED CUTTING EDGES

Corner bead without covered cutting edge PVC

Corner profile for façade cladding of 16 mm.

Notes:

Attached PVC Clip-on profiles reduce the ingress of water.

Item number	Material	Length (cm)	Order number	Color	Package/ Large pack
3506	Hard PVC	300	100250	47 - brown	10 PCS / 28 BUN
	Hard PVC	300	100249	33 - brick-red	10 PCS / 28 BUN
	Hard PVC	300	100248	10 - white	10 PCS / 28 BUN
	Hard PVC	300	100251	90 - black	10 PCS / 28 BUN

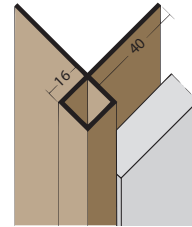

Corner bead without covered cutting edge PVC

Y corner profile for 11 mm façade cladding, also an accessory for natural slate panels.

Notes:

Attached PVC Clip-on profiles reduce the ingress of water.

Item number	Material	Length (cm)	Order number	Color	Package/ Large pack
3674	Hard PVC	300	100059	90 - black	10 PCS / 49 BUN

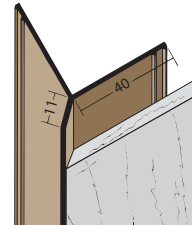

FACADE PROFILES EDGE FORMATION

CORNER PROFILES WITH COVERED CUTTING EDGES



NOTES

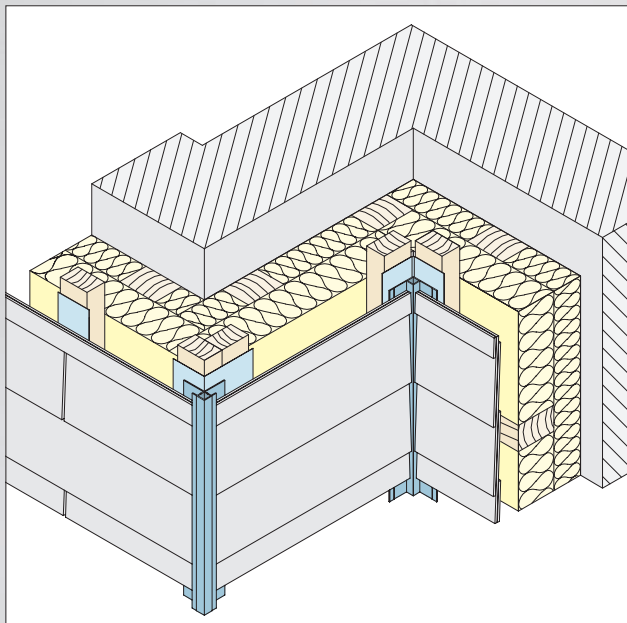

Corner profiles are used for facade design. They fully cover and protect the cutting edges of the facade boards and thus form a clean, precise edge.

The guidelines of board and substructure manufacturers as well as all applicable requirements, standards and directives must be taken into consideration and observed when selecting and installing the corner profiles.

Vertical corner profiles must be fastened at one fixed point at the top. If conditions require multiple fastening points on a profile, the other fastenings must be sliding points.

Profiles must always be mounted without pressure or stress to allow for expansion. Joints must be appropriate for requirements.

Please consult the product literature and the general notes on the installation of facade profiles.

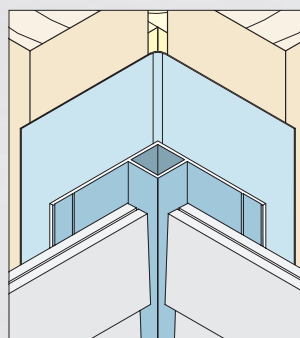
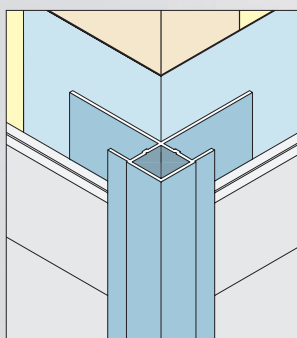

CORNER PROFILES

CORNER PROFILES WITH COVERED CUTTING EDGES

Corner bead with covered cutting edge Alu

Corner profile for façade cladding of up to 6.5 mm. Please observe the application instructions and technical requirements.

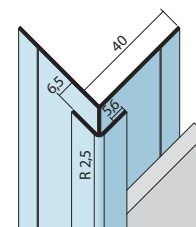

Item number	Material	Length (cm)	Order number	Color	Package/ Large pack
9444	Aluminum	300	108201	NA - natur	10 PCS / 36 BUN
9445	Aluminum	300	108202	EV - E6 EV1	10 PCS / 70 BUN

Corner bead with covered cutting edge Alu

Corner profile for façade cladding of up to 8.5 mm. Please observe the application instructions and technical requirements.

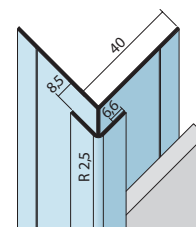

Item number	Material	Length (cm)	Order number	Color	Package/ Large pack
9446	Aluminum	300	108203	NA - natur	10 PCS / 33 BUN
9447	Aluminum	300	108204	EV - E6 EV1	10 PCS / 70 BUN

Corner bead with covered cutting edge Alu

Corner profile for façade cladding of up to 10.5 mm. Please observe the application instructions and technical requirements.

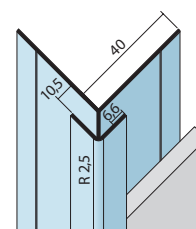

Item number	Material	Length (cm)	Order number	Color	Package/ Large pack
9449	Aluminum	300	108206	EV - E6 EV1	10 PCS / 30 BUN

Corner bead with covered cutting edge PVC

Corner profile for façade cladding of up to 11 mm.

Notes:
Attached PVC Clip-on profiles reduce the ingress of water.

Item number	Material	Length (cm)	Order number	Color	Package/ Large pack
3624	Hard PVC	300	101341	90 - black	10 PCS / 30 BUN
	Hard PVC	300	101333	10 - white	10 PCS / 30 BUN
	Hard PVC	300	101336	33 - brick-red	10 PCS / 30 BUN
	Hard PVC	300	101338	47 - brown	10 PCS / 30 BUN

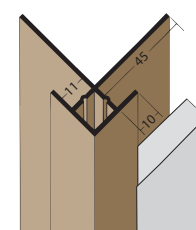

CORNER PROFILES

CORNER PROFILES WITH COVERED CUTTING EDGES

Corner bead with covered cutting edge PVC

Corner profile for façade cladding of up to 14 mm.

Notes:
Attached PVC Clip-on profiles reduce the ingress of water. Corners can be shaped using white or black 3503 adapter profiles.

Item number	Material	Length (cm)	Order number	Color	Package/ Large pack
3504	Hard PVC	250	113994	10 - white	10 PCS / 24 BUN
	Hard PVC	250	113996	47 - brown	10 PCS / 24 BUN
	Hard PVC	250	113995	33 - brick-red	10 PCS / 24 BUN
	Hard PVC	250	113997	90 - black	10 PCS / 24 BUN
	Hard PVC	300	114000	47 - brown	10 PCS / 24 BUN
	Hard PVC	300	113999	33 - brick-red	10 PCS / 24 BUN
	Hard PVC	300	113998	10 - white	10 PCS / 24 BUN
	Hard PVC	300	114001	90 - black	10 PCS / 24 BUN

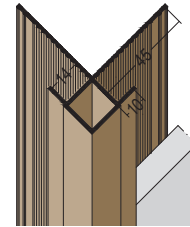

Corner bead with covered cutting edge PVC

Corner profile for façade cladding of up to 17 mm.

Notes:
Attached PVC Clip-on profiles reduce the ingress of water. Corners can be rendered using white or black 3575 adapter profiles.

Item number	Material	Length (cm)	Order number	Color	Package/ Large pack
3555	Hard PVC	250	100603	90 - black	10 PCS / 24 BUN
	Hard PVC	250	100602	47 - brown	10 PCS / 24 BUN
	Hard PVC	250	100601	33 - brick-red	10 PCS / 24 BUN
	Hard PVC	250	100598	10 - white	10 PCS / 24 BUN
	Hard PVC	300	100607	47 - brown	10 PCS / 24 BUN
	Hard PVC	300	100606	33 - brick-red	10 PCS / 24 BUN
	Hard PVC	300	100609	90 - black	10 PCS / 24 BUN
	Hard PVC	300	100605	10 - white	10 PCS / 24 BUN

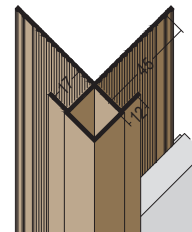

Corner bead with covered cutting edge PVC

Corner profile for façade cladding of up to 20 mm.

Notes:
Attached PVC Clip-on profiles reduce the ingress of water.

Item number	Material	Length (cm)	Order number	Color	Package/ Large pack
3501	Hard PVC	250	100197	90 - black	10 PCS / 20 BUN
	Hard PVC	300	100201	90 - black	10 PCS / 20 BUN

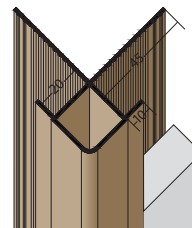

Corner bead with covered cutting edge PVC

Corner profile for façade cladding of up to 27 mm.

Notes:
Attached PVC Clip-on profiles reduce the ingress of water.

Item number	Material	Length (cm)	Order number	Color	Package/ Large pack
3590	Hard PVC	300	100913	10 - white	6 PCS / 20 BUN
	Hard PVC	300	100918	90 - black	6 PCS / 20 BUN

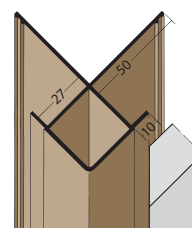

CORNER PROFILES

CORNER PROFILES WITH COVERED CUTTING EDGES

Corner adaptor piece PVC

The 3503 adaptor profile is suited for corner profile 3504.

The 3575 adaptor profile is suited for corner profile 3555.

Notes:

The colour of the corner adapters may deviate slightly from the corner profiles.

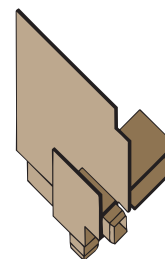

Item number	Material	Length (cm)	Order number	Color	Package/ Large pack
3503	Hard PVC	5	102260	90 - black	50 PC / 20 BOX
3575	Hard PVC	8	102273	10 - white	50 PC / 25 BOX
	Hard PVC	8	102281	90 - black	50 PC / 25 BOX

FACADE PROFILES EDGE FORMATION APPLICATION INSTRUCTIONS

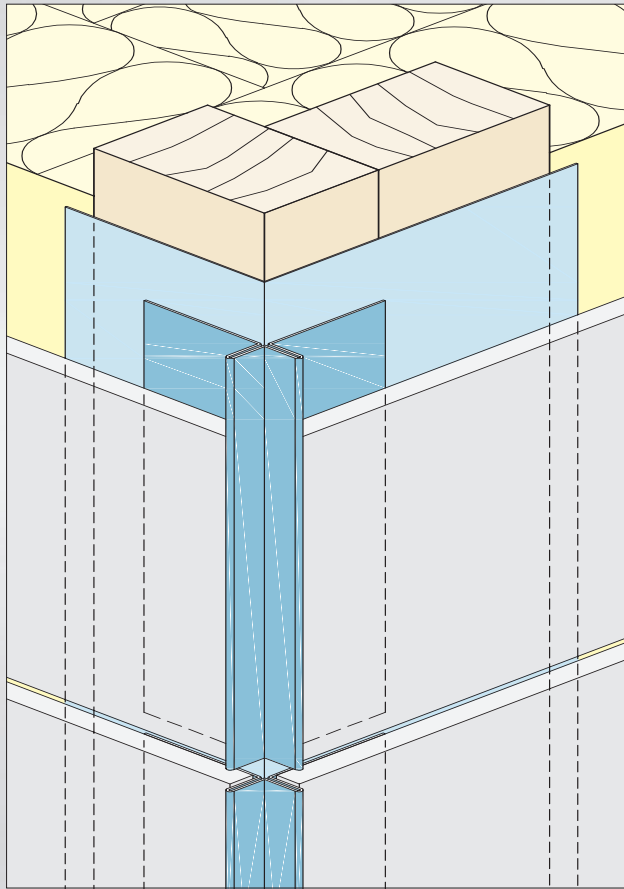

When aluminium corner profiles are used, the vertical profile should may correspond with a joint of the facade cladding. The general use of joint tapes can prevent water from penetrating.

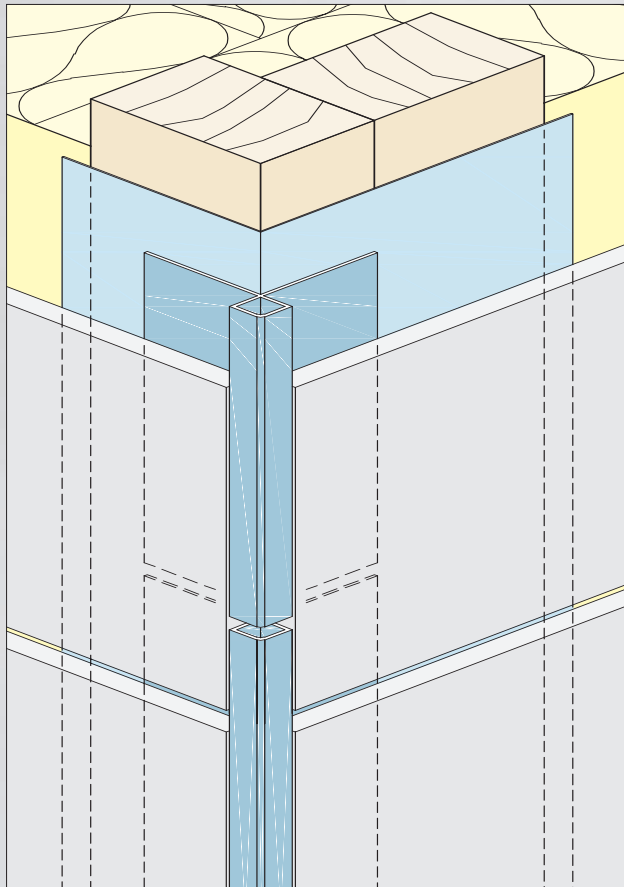

The vertical profile joints of the aluminium corner profiles can also be offset with the joint of the facade cladding. The general use of joint tapes can prevent water from penetrating.

Like most components of curtain walls, the facade profiles must not be constrained. Always allow for linear expansion in the profiles.

FACADE PROFILES EDGE FORMATION

CORNER PROFILES FOR INSIDE CORNERS

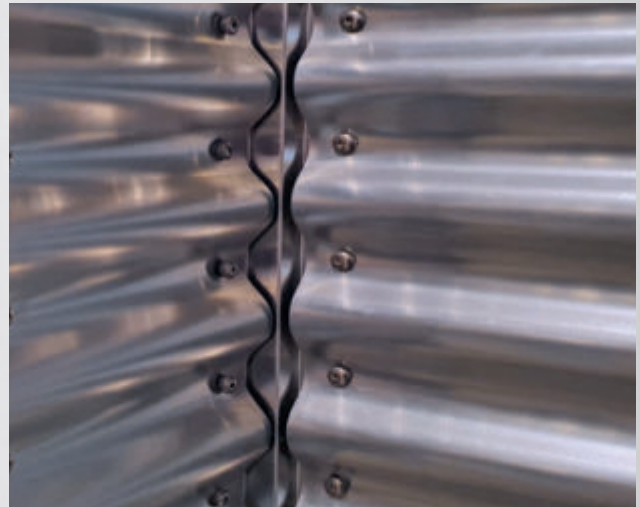

INSTRUCTIONS FOR APPLICATION

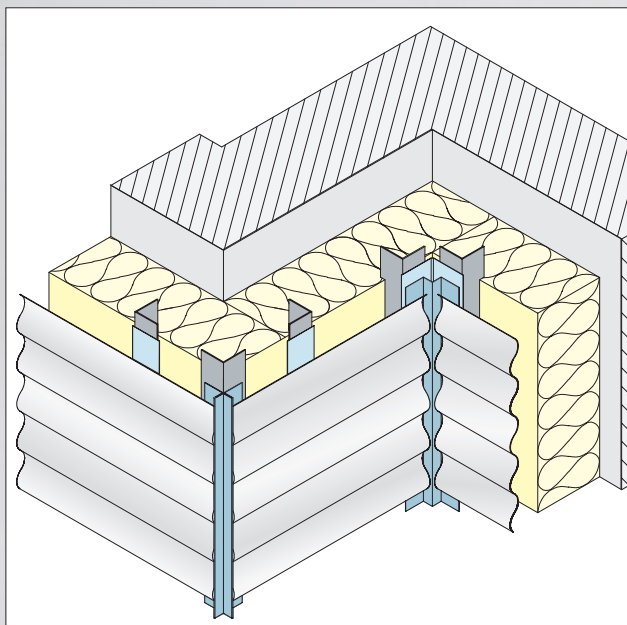

Corner profiles for inside corners form a clean, precise facade cladding stop.

The guidelines of board and substructure manufacturers as well as all applicable requirements, standards and directives must be taken into consideration and observed when selecting and installing the corner profiles.

Vertical corner profiles must be fastened at one fixed point at the top. If conditions require multiple fastening points on a profile, the other fastenings must be sliding points.

Profiles must always be mounted without pressure or stress to allow for expansion. Joints must be appropriate for requirements.

Please consult the product literature and the general notes on the installation of facade profiles.

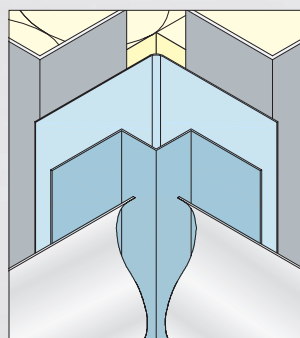
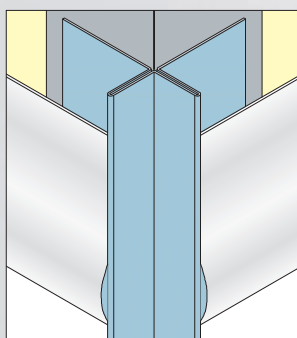

CORNER PROFILES

INSIDE CORNER

Corner bead for inside corners Alu

Corner profile for interior edges,
for façade cladding of up to 12 mm.
Please observe the application instructions
and technical requirements.

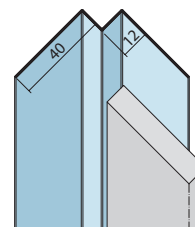

Item number	Material	Length (cm)	Order number	Color	Package/ Large pack
9432	Aluminum	250	108212	NA - natur	10 PCS / 90 BUN

Corner bead for inside corners Alu

Corner profile for interior edges
on façade cladding of up to 25 mm.
Please observe the application instructions
and technical requirements.

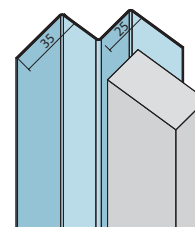

Item number	Material	Length (cm)	Order number	Color	Package/ Large pack
9486	Aluminum	300	109704	NA - natur	10 PCS / 100 BUN

Corner bead for inside corners PVC

Corner profile for interior edges
on façade cladding of up to 15 mm.

Notes:
Attached PVC Clip-on profiles reduce the
ingress of water.

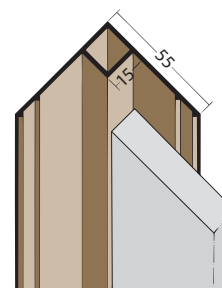

Item number	Material	Length (cm)	Order number	Color	Package/ Large pack
3505	Hard PVC	300	100236	10 - white	10 PCS / 34 BUN
	Hard PVC	300	100239	90 - black	10 PCS / 34 BUN

FACADE PROFILES EDGE FORMATION APPLICATION INSTRUCTIONS

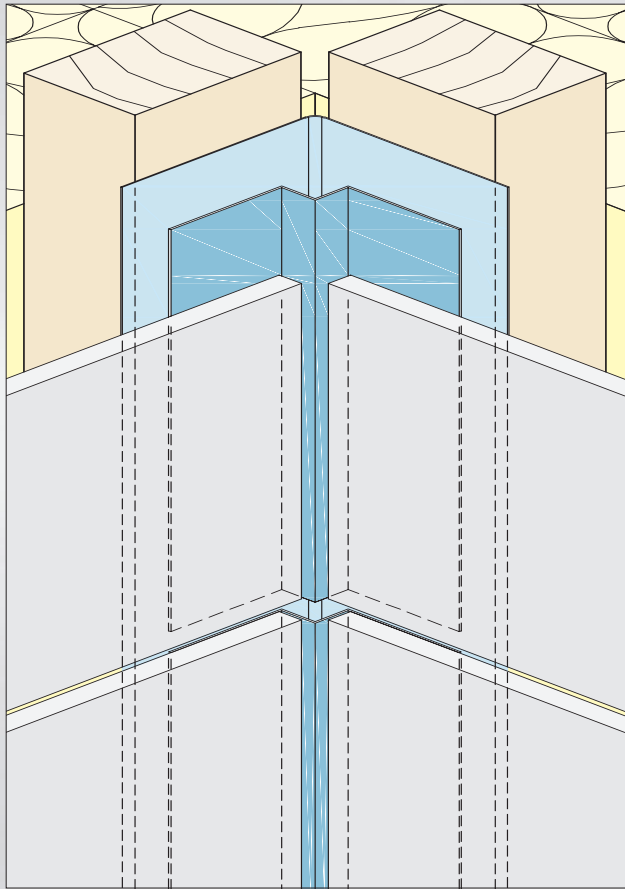

When aluminium corner profiles are used, the vertical profile should may correspond with a joint of the facade cladding. The general use of joint tapes can prevent water from penetrating.

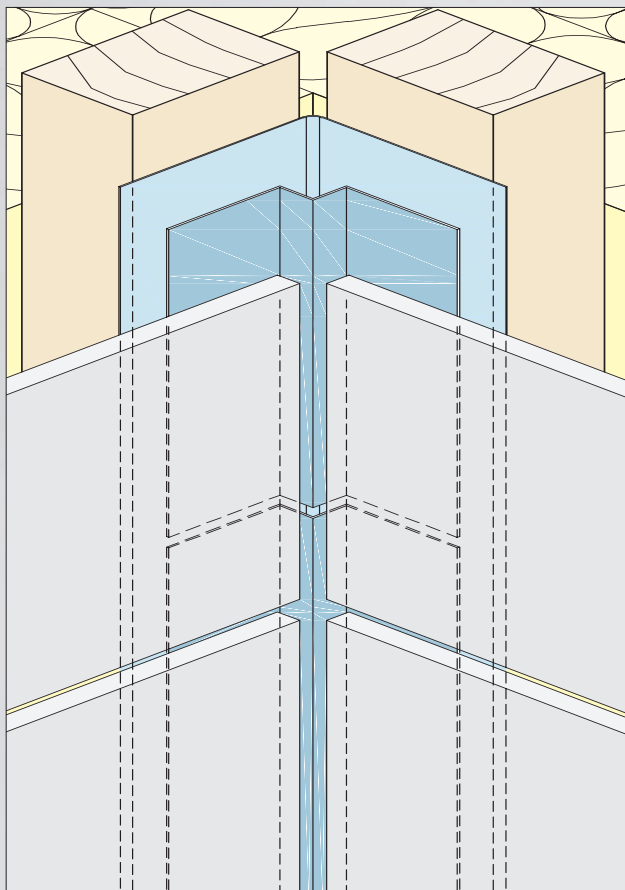

The vertical profile joints of the aluminium corner profiles can also be offset with the joint of the facade cladding. The general use of joint tapes can prevent water from penetrating.

Like most components of curtain walls, the facade profiles must not be constrained. Always allow for linear expansion in the profiles.

FACADE PROFILES REVEAL FORMATION

CONNECTING PROFILES AND PROFILE EDGINGS



NOTES

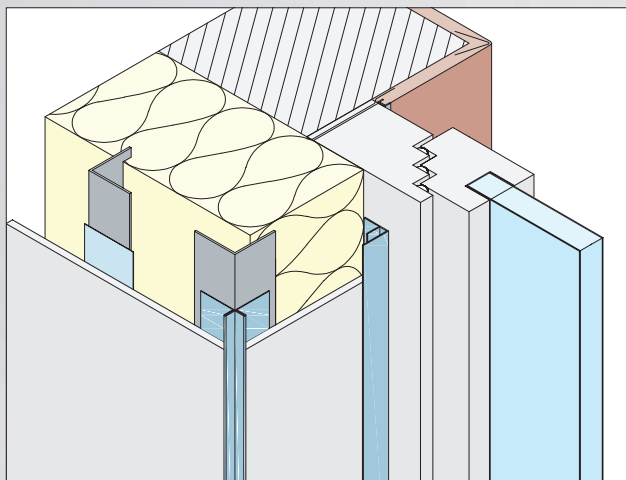

The reveal may be built in different ways. In practice, depending on what the planer/contractor/builder-owner prefers, the facade cladding is continued in the reveal or preexisting reveal systems are taken into account.

Protektor offers different systems or system components for these applications.

By means of f-profiles, the facade boards can be optimally attached in different locations, such as window and door reveals. Due to a covering of the cutting edges with the profiles, irregularities can easily be concealed and aligned.

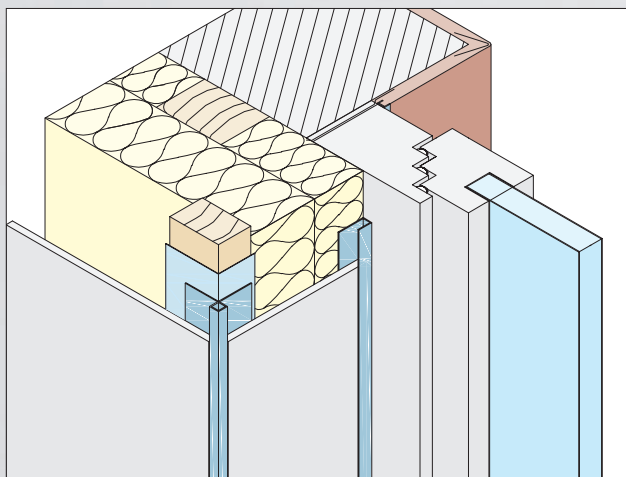

By means of connecting profiles and profile edgings as well as u-profiles, the facade boards can be optimally attached in different locations, such as window and door reveals.

CONNECTING- AND STOP PROFILES

Connecting profile F-profile Alu EV1

F-profile for façade cladding of up to 8.5 mm.

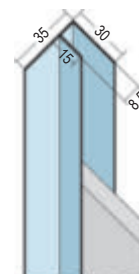

Item number	Material	Length (cm)	Order number	Color	Package/ Large pack
9085	Aluminum	300	106879	EV - E6 EV1	10 PCS / 40 BUN

Connecting profile F-profile Alu EV1

F-profile for façade cladding of up to 10.5 mm.

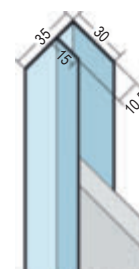

Item number	Material	Length (cm)	Order number	Color	Package/ Large pack
9090	Aluminum	300	110861	EV - E6 EV1	10 PCS / 80 BUN

Connecting profile U-profile Alu

U-profile for facade cladding up to 6.5 mm.

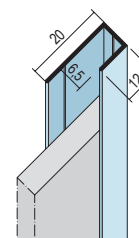

NEW

Item number	Material	Length (cm)	Order number	Color	Package/ Large pack
97043	Aluminum, anodized	300	118565	NA - natur	10 PCS / 101 BUN

Connecting profile U-profile Alu

U-profile for façade cladding of up to 8.5 mm.

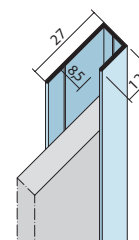

Item number	Material	Length (cm)	Order number	Color	Package/ Large pack
9450	Aluminum	300	108207	NA - natur	10 PCS / 101 BUN

Connecting profile U-profile Alu

U-profile for façade cladding of up to 10.5 mm.

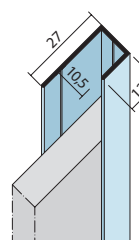

Item number	Material	Length (cm)	Order number	Color	Package/ Large pack
9451	Aluminum	300	108196	NA - natur	10 PCS / 150 BUN

CONNECTING- AND STOP PROFILES

Connecting profile U-profile Alu

U-profile for façade cladding of up to 13 mm.

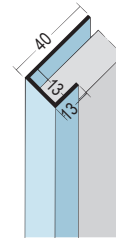

Item number	Material	Length (cm)	Order number	Color	Package/ Large pack
9407	Aluminum	250	101727	NA - natur	10 PCS / 75 BUN

Connecting profile U-profile Alu

U-profile for façade cladding of up to 16 mm.

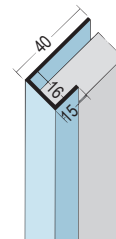

Item number	Material	Length (cm)	Order number	Color	Package/ Large pack
9408	Aluminum	250	101732	NA - natur	10 PCS / 90 BUN

Connecting profile U-profile Alu

U-profile for façade cladding of up to 20 mm.

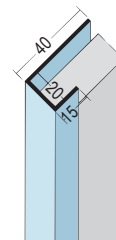

Item number	Material	Length (cm)	Order number	Color	Package/ Large pack
9409	Aluminum	250	101735	NA - natur	10 PCS / 75 BUN

Edging profile Alu

Edging profile for façade cladding of 25 mm.

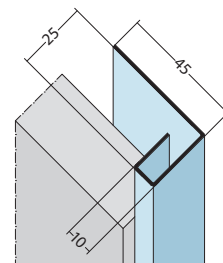

Item number	Material	Length (cm)	Order number	Color	Package/ Large pack
9487	Aluminum	300	109705	NA - natur	10 PCS / 50 BUN

CONNECTING- AND STOP PROFILES

Connecting profile U-profile PVC

U-profile for façade cladding of up to 6.5 mm.

Item number	Material	Length (cm)	Order number	Color	Package/ Large pack
3691	Hard PVC	250	102076	10 - white	10 PCS / 153 BUN
	Hard PVC	300	102094	47 - brown	10 PCS / 153 BUN
	Hard PVC	300	102095	90 - black	10 PCS / 153 BUN
	Hard PVC	300	102091	10 - white	10 PCS / 153 BUN
	Hard PVC	500	102107	90 - black	10 PCS / 55 BUN
	Hard PVC	500	102098	10 - white	10 PCS / 55 BUN

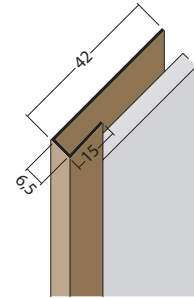

Connecting profile U-profile PVC

U-profile for façade cladding of up to 9 mm.

Item number	Material	Length (cm)	Order number	Color	Package/ Large pack
3658	Hard PVC	250	101541	10 - white	10 PCS / 119 BUN
	Hard PVC	250	101583	90 - black	10 PCS / 119 BUN
	Hard PVC	250	101556	33 - brick-red	10 PCS / 119 BUN
	Hard PVC	250	101567	47 - brown	10 PCS / 119 BUN
	Hard PVC	300	101607	90 - black	10 PCS / 119 BUN
	Hard PVC	500	101642	90 - black	10 PCS / 40 BUN

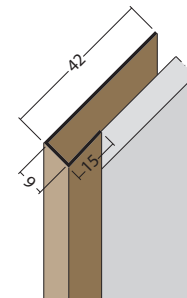

Connecting profile U-profile PVC

U-profile for façade cladding of up to 13 mm.

Item number	Material	Length (cm)	Order number	Color	Package/ Large pack
3563	Hard PVC	250	100688	90 - black	10 PCS / 117 BUN
	Hard PVC	300	100693	47 - brown	10 PCS / 117 BUN
	Hard PVC	300	100690	10 - white	10 PCS / 117 BUN
	Hard PVC	300	100692	33 - brick-red	10 PCS / 117 BUN
	Hard PVC	300	100695	90 - black	10 PCS / 117 BUN
	Hard PVC	500	100697	10 - white	10 PCS / 40 BUN
	Hard PVC	500	100702	90 - black	10 PCS / 40 BUN

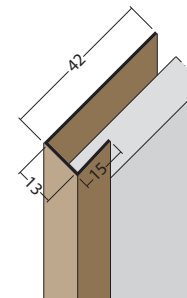

Connecting profile U-profile PVC

U-profile for façade cladding of up to 17 mm.

Item number	Material	Length (cm)	Order number	Color	Package/ Large pack
3529	Hard PVC	250	100344	10 - white	10 PCS / 110 BUN
	Hard PVC	250	100345	33 - brick-red	10 PCS / 110 BUN
	Hard PVC	250	100346	47 - brown	10 PCS / 110 BUN
	Hard PVC	250	100347	90 - black	10 PCS / 110 BUN
	Hard PVC	300	100351	90 - black	10 PCS / 110 BUN
	Hard PVC	500	100355	90 - black	10 PCS / 40 BUN
	Hard PVC	500	100354	47 - brown	10 PCS / 40 BUN
	Hard PVC	500	100352	10 - white	10 PCS / 40 BUN

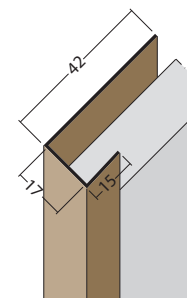

CONNECTING- AND STOP PROFILES

Connecting profile U-profile PVC

U-profile for façade cladding of up to 20 mm.

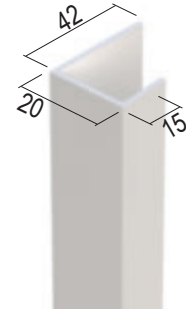

Item number	Material	Length (cm)	Order number	Color	Package/ Large pack
3502	Hard PVC	250	100206	10 - white	10 PCS / 90 BUN
	Hard PVC	250	100209	90 - black	10 PCS / 90 BUN
	Hard PVC	300	100211	10 - white	10 PCS / 90 BUN
	Hard PVC	500	100219	90 - black	10 PCS / 32 BUN
	Hard PVC	500	100216	10 - white	10 PCS / 32 BUN
	Hard PVC	500	100218	47 - brown	10 PCS / 20 BUN

Connecting profile U-profile PVC

U-profile for façade cladding of up to 27 mm.

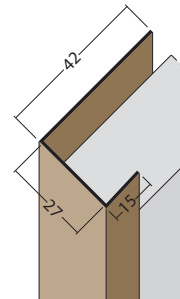

Item number	Material	Length (cm)	Order number	Color	Package/ Large pack
3527	Hard PVC	250	100327	90 - black	10 PCS / 90 BUN
	Hard PVC	250	100324	10 - white	10 PCS / 90 BUN
	Hard PVC	250	100326	47 - brown	10 PCS / 90 BUN
	Hard PVC	300	100328	10 - white	10 PCS / 90 BUN

Connecting profile U-profile PVC

11 x 40 mm U-profile for façade cladding of up to 11 mm.

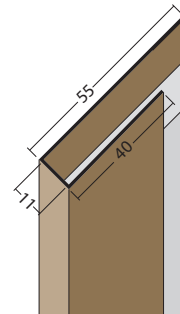

Item number	Material	Length (cm)	Order number	Color	Package/ Large pack
SALE 3609	Hard PVC	250	101017	90 - black	20 PCS / 34 BUN

CONNECTING- AND STOP PROFILES

EDGING / RAIN / PLINTH PROFILES

Rain repelling profile PVC

Rain repellent profile for protecting façade cladding.

Item number	Material	Length (cm)	Order number	Color	Dimension a (mm)	Package/ Large pack
3588	Hard PVC	250	100888	90 - black	8,5 mm	20 PCS / 56 BUN
3589	Hard PVC	250	100897	10 - white	12,5 mm	20 PCS / 56 BUN

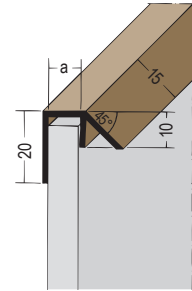

Socle profile-Z Alu

Wall base z-profile for covering façade cladding of up to 11.5 mm.



Item number	Material	Length (cm)	Order number	Color	Dimension a (mm)	Package/ Large pack
9083	Aluminum	250	101622	NA - natur	11,5 mm	10 PCS / 140 BUN

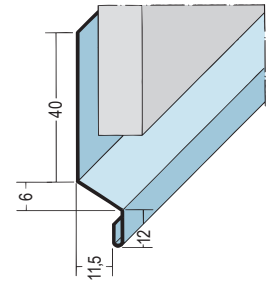

Socle profile-Z PVC

Wall base z-profile for covering façade cladding of up to 13.5 mm.

Item number	Material	Length (cm)	Order number	Color	Dimension a (mm)	Package/ Large pack
3820	Hard PVC	200	102990	90 - black	13,8 mm	20 PCS / 80 BUN

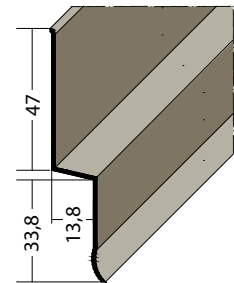

FACADE PROFILES CONNECTION STRUCTURE

CONNECTING PROFILES WITHOUT COVERED CUTTING EDGES



INSTRUCTIONS FOR APPLICATION

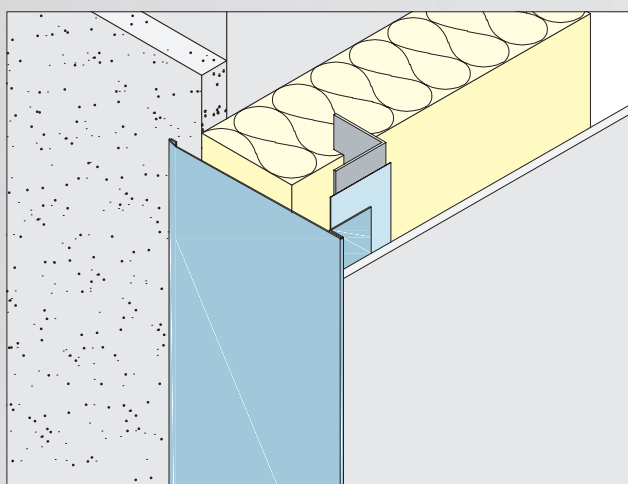

The connecting profiles connect the facade cladding and the different surfaces of the facade, such as the plaster, and thus facilitate a simple and precise transition. They fully cover and protect the cutting edges of the facade boards and cover the substructure on the side.

The connecting profiles may also be used for connections to windows and doors.

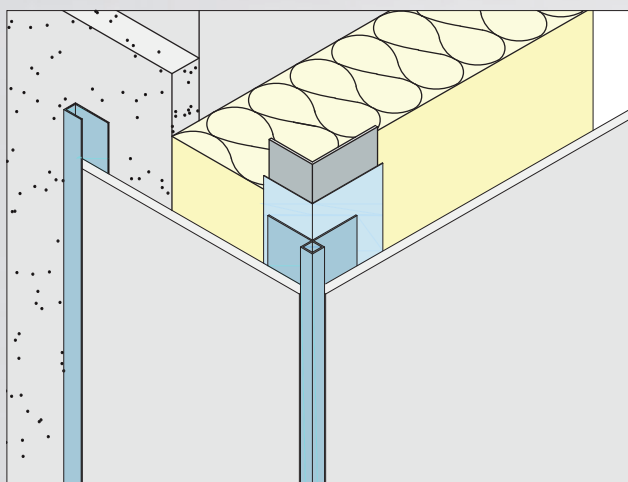

The connection of a curtain wall via a corner to another surface, for example a plastered surface or ETICS, can easily be carried out with an edge profile and a U-edge profile. For example, here with edge profile no. 9440 and U-edge profile no. 9450. Protektor has a large selection of façade profiles.

CONNECTING- AND STOP PROFILES

CONNECTING PROFILES

Connection profile without covered cutting edge Alu

Connection profile for façade claddings of 13 mm.

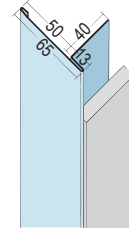

Item number	Material	Length (cm)	Order number	Color	Package/ Large pack
9081	Aluminum	250	101616	NA - natur	10 PCS / 40 BUN

Connection profile with covered cutting edge PVC

Connection profile for façade cladding of up to 13.5 mm.

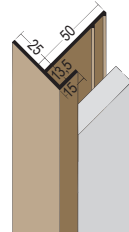

SALE

Item number	Material	Length (cm)	Order number	Color	Package/ Large pack
3560	Hard PVC	300	100634	10 - white	10 PCS / 54 BUN
	Hard PVC	300	100637	90 - black	10 PCS / 54 BUN

Connection profile with covered cutting edge PVC

Connection profile for façade cladding of up to 13 mm.

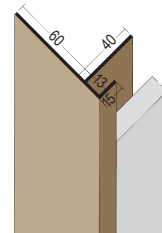

SALE

Item number	Material	Length (cm)	Order number	Color	Package/ Large pack
3561	Hard PVC	300	100650	10 - white	10 PCS / 40 BUN
	Hard PVC	300	100655	90 - black	10 PCS / 40 BUN

Connection profile with covered cutting edge PVC

Connection profile for façade cladding of up to 17 mm.

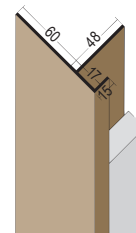

Item number	Material	Length (cm)	Order number	Color	Package/ Large pack
3562	Hard PVC	300	100675	90 - black	10 PCS / 36 BUN
	Hard PVC	300	100670	10 - white	10 PCS / 36 BUN

FACADE PROFILES CONNECTION STRUCTURE

APPLICATION INSTRUCTIONS

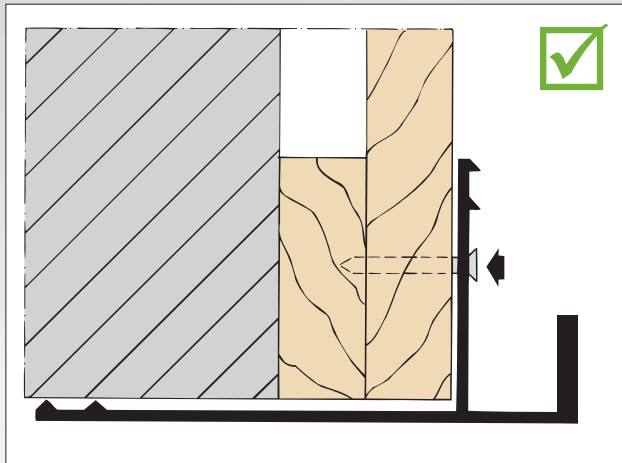

CORRECT

Lightly place the profile in the corner and nail without applying pressure. This ensures that the nailed side does not press inward, which eliminates the risk of tension in the profile.

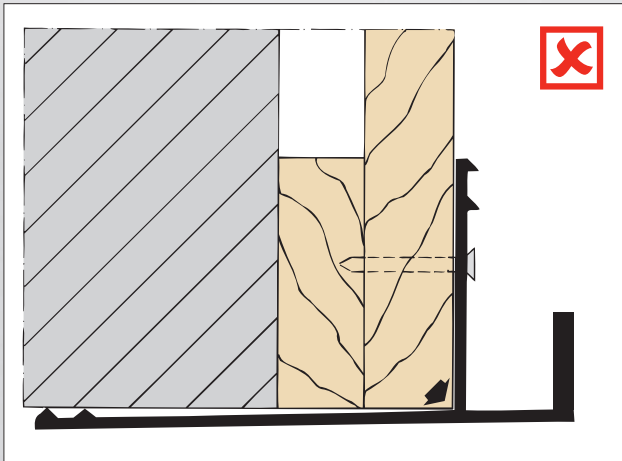

INCORRECT

If the profile is pressed into the corner too tightly, it creates tension on the non-fastened part of the profile, which causes the profile to bend.

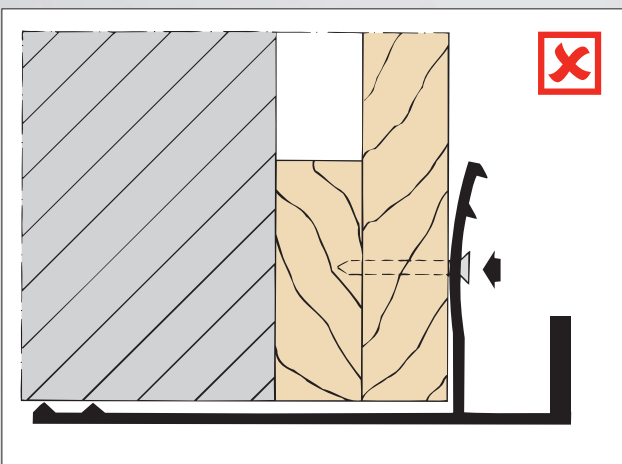

INCORRECT

If the nail is driven in too deeply at the fastening point, tension is created and the profile starts to bend in direct sunlight.

FACADE PROFILES JOINT STRUCTURE

JOINT PROFILES (CORRUGATED PROFILE) VERTICAL AND HORIZONTAL



INSTRUCTIONS FOR APPLICATION

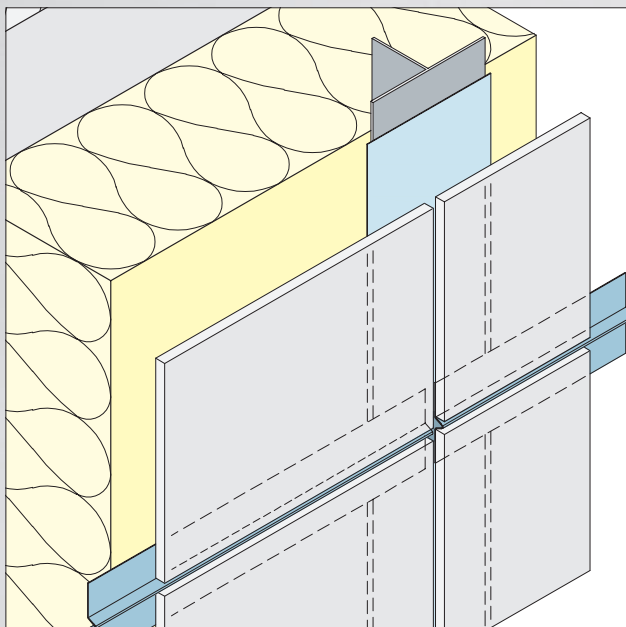

The aluminium joint profile or corrugated profile subtly depicts the joint whilst effectively closing it. The beading along the profile also centres and guides the facade cladding joint. The profiles are therefore available in widths of 6 mm and 9 mm for different joint widths. The corrugated profile may be used horizontally or vertically.

If used horizontally and if no horizontal substructure exists, the profile must be fastened on the rearside of the facade in a sliding manner. Fastening either by means of suitable adhesives or mechanically (screws, rivets etc.), depending on the requirements and distances of the vertical substructure. Please observe the guidelines of the facade cladding manufacturers for this practice.

When installing large facade slabs or boards, ensure that a joint remains as indicated by the slab or boards manufacturer.

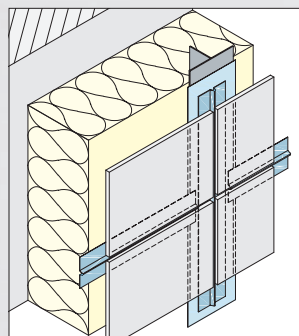
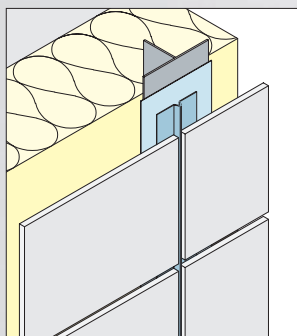

JOINT PROFILES

JOINT PROFILES VERTICAL AND HORIZONTAL

Joint profile vertical and horizontal Alu

Joint or bead profile for joint thickness of 8 mm.

Processing instructions: Horizontal and vertical installation.



Item number	Material	Length (cm)	Order number	Color	Package/ Large pack
9053	Aluminum	250	101578	NA - natur	20 PCS / 90 BUN
9042	Aluminum	250	101191	90 - black	20 PCS / 90 BUN

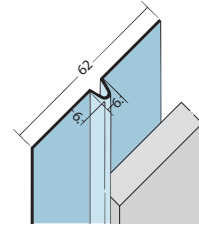

Joint profile vertical and horizontal Alu black

Joint or bead profile for joint thickness of 10 mm.

Processing instructions: Horizontal and vertical installation.

Item number	Material	Length (cm)	Order number	Color	Package/ Large pack
9054	Aluminum	250	108209	90 - black	20 PCS / 150 BUN

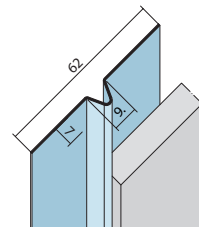

FACADE PROFILES JOINT STRUCTURE

JOINT PROFILES ONLY HORIZONTAL



INSTRUCTIONS FOR APPLICATION

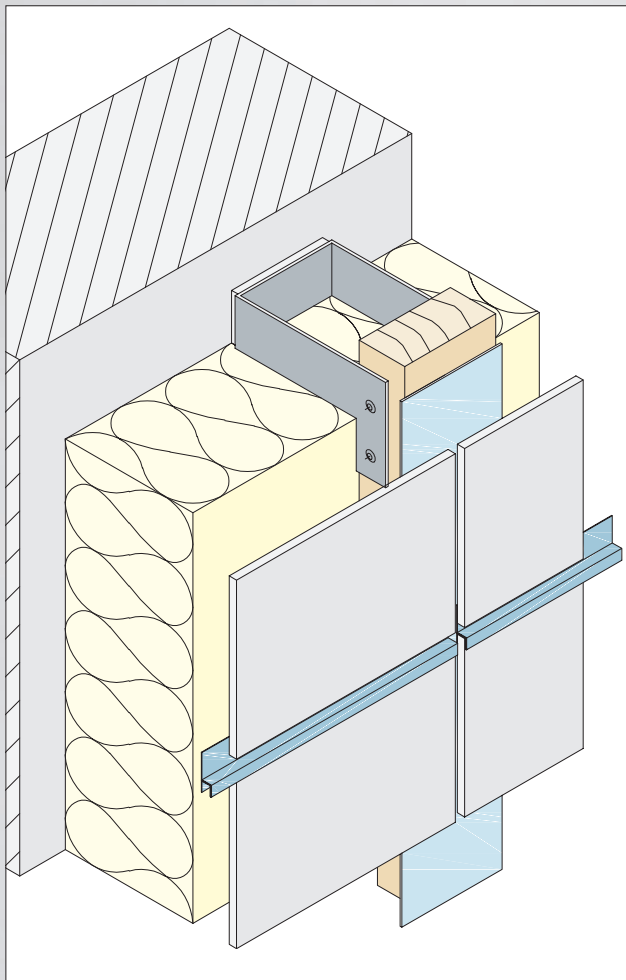

The joint profiles or h-profiles made of aluminium or PVC are used for horizontal joints. They reduce the penetration of moisture. Please ensure that the boards are not placed directly on the profile but that a joint of approx. 5 to 10 mm remains as indicated by the facade cladding manufacturer.

For the horizontal joint profiles, keep in mind that the profiles expand due to fluctuations in temperature. To stop the profiles from moving, they must be fastened with one fixed point, e. g. in the middle of the profile. If conditions require multiple fastening points on a profile, the other fastenings must be sliding points. Do not constrain the profiles and ensure that there is room for expansion.

The facade profiles should generally be shortened to the length or width of the installed board sizes. PVC joint profiles can only be used in white and for small facade boards. Please consult the product literature and the general notes on the installation of facade profiles.

JOINT PROFILES

JOINT PROFILES HORIZONTAL

Joint-h-profile horizontal Alu black

Joint h-profile for façade cladding of up to 4.6 mm.

Processing instructions: Only suitable for horizontal installation!

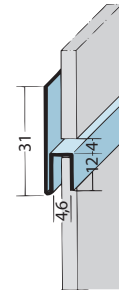

Item number	Material	Length (cm)	Order number	Color	Package/ Large pack
9047	Aluminum	250	101214	90 - black	20 PCS / 35 BUN

SALE

Joint-h-profile horizontal Alu

Joint h-profile for façade cladding of up to 7 mm.

Processing instructions: Only suitable for horizontal installation!

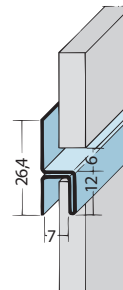

Item number	Material	Length (cm)	Order number	Color	Package/ Large pack
9061	Aluminum	250	101595	NA - natur	20 PCS / 100 BUN
9048	Aluminum	250	101227	90 - black	20 PCS / 100 BUN

Joint-h-profile horizontal Alu

Joint h-profile for façade cladding of up to 9 mm.

Processing instructions: Only suitable for horizontal installation!

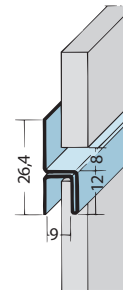

Item number	Material	Length (cm)	Order number	Color	Package/ Large pack
9062	Aluminum	250	101601	NA - natur	20 PCS / 100 BUN
9049	Aluminum	250	101233	90 - black	20 PCS / 100 BUN

Joint profile horizontal Alu

Joint h-profile for façade cladding of up to 8 mm.

Processing instructions: Only suitable for horizontal installation!

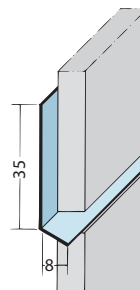

Item number	Material	Length (cm)	Order number	Color	Package/ Large pack
9092	Aluminum	250	101660	NA - natur	20 PCS / 100 BUN

Joint-h-profile horizontal Alu EV1

Joint h-profile for façade cladding of up to 7 mm.

Processing instructions: Only suitable for horizontal installation!

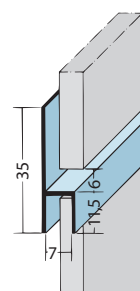

Item number	Material	Length (cm)	Order number	Color	Package/ Large pack
9086	Aluminum	250	102462	EV - E6 EV1	10 PCS / 200 BUN

JOINT PROFILES

JOINT PROFILES HORIZONTAL

Joint-h-profile horizontal Alu EV1

Joint h-profile for façade cladding of up to 8.8 mm.

Processing instructions: Only suitable for horizontal installation!



Item number	Material	Length (cm)	Order number	Color	Package/ Large pack
9087	Aluminum	250	102469	EV - E6 EV1	10 PCS / 200 BUN

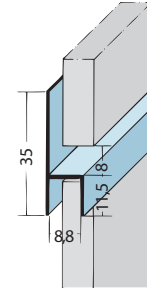

Joint-h-profile horizontal Alu EV1

Joint h-profile for façade cladding of up to 11 mm.

Processing instructions: Only suitable for horizontal installation!



Item number	Material	Length (cm)	Order number	Color	Package/ Large pack
9088	Aluminum	250	110860	EV - E6 EV1	10 PCS / 140 BUN

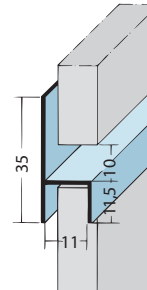

Joint-h-profile horizontal Alu EV1

Joint h-profile for façade cladding of up to 12.8 mm.

Processing instructions: Only suitable for horizontal installation!



Item number	Material	Length (cm)	Order number	Color	Package/ Large pack
9089	Aluminum	250	102475	EV - E6 EV1	10 PCS / 200 BUN

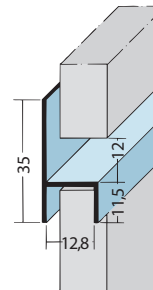

Joint-h-profile horizontal PVC

Joint h-profile for façade cladding of up to 6.5 mm.

Processing instructions: Only suitable for horizontal installation!

Item number	Material	Length (cm)	Order number	Color	Package/ Large pack
3534	Hard PVC	250	100364	10 - white	20 PCS / 98 BUN

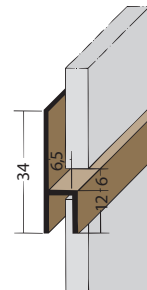

Joint-h-profile horizontal PVC

Joint h-profile for façade cladding of up to 8.5 mm.

Processing instructions: Only suitable for horizontal installation!

Item number	Material	Length (cm)	Order number	Color	Package/ Large pack
3535	Hard PVC	250	100372	10 - white	20 PCS / 91 BUN

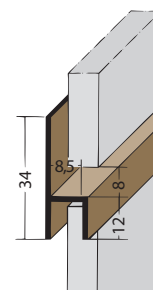

JOINT PROFILES

JOINT PROFILES HORIZONTAL

Joint-h-profile horizontal PVC

Joint h-profile for façade cladding of up to 10.5 mm.

Processing instructions: Only suitable for horizontal installation!

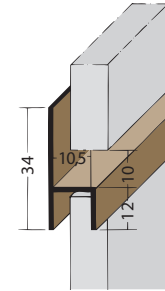

Item number	Material	Length (cm)	Order number	Color	Package/ Large pack
3536	Hard PVC	250	100381	10 - white	20 PCS / 65 BUN

Joint-h-profile horizontal PVC

Joint h-profile for façade cladding of up to 10.5 mm.

Processing instructions: Only suitable for horizontal installation!

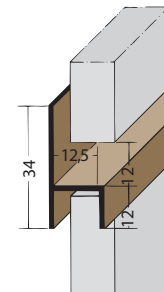

Item number	Material	Length (cm)	Order number	Color	Package/ Large pack
3537	Hard PVC	250	100394	10 - white	20 PCS / 84 BUN

Joint-Z-profil horizontal PVC

Joint Z-profile for façade cladding of up to 23.5 mm.

Processing instructions: Only suitable for horizontal installation!

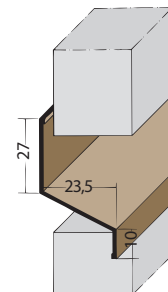

Item number	Material	Length (cm)	Order number	Color	Package/ Large pack
3554	Hard PVC	250	100590	90 - black	20 PCS / 110 BUN

FACADE PROFILES JOINT STRUCTURE

JOINT PROFILES ONLY VERTICAL



INSTRUCTIONS FOR APPLICATION

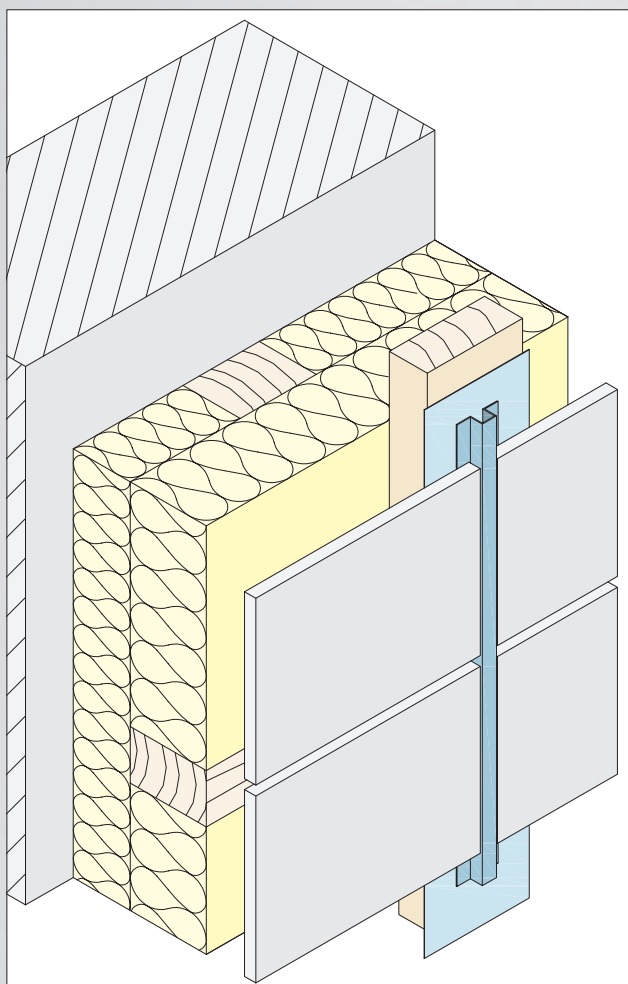

The joint profiles made of aluminium or PVC are used for vertical joints. Ensure that the facade cladding has room for expansion depending on the particular application. The aluminium joint profiles and top hat profiles can be installed on the front or the rearside of the facade cladding.

JOINT PROFILES

JOINT PROFILES VERTICAL

Joint profile vertical hat Alu

Hat profile
for façade cladding of 12.5 mm.

Processing instructions: Only for vertical installation!

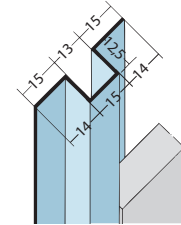

Item number	Material	Length (cm)	Order number	Color	Package/ Large pack
9311	Aluminum	250	101694	NA - natur	20 PCS / 100 BUN

Joint profile vertical Alu

Joint/pilaster strip profile
for façade cladding of 20 mm.

Processing instructions: Only for vertical installation!

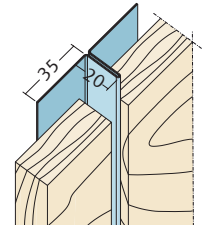

Item number	Material	Length (cm)	Order number	Color	Package/ Large pack
9027	Aluminum	250	109730	NA - natur	10 PCS / 48 BUN

Joint-H-profile vertical Alu EV1

Joint h-profile
for façade cladding of up to 6.5 mm.

Processing instructions: Only for vertical installation!

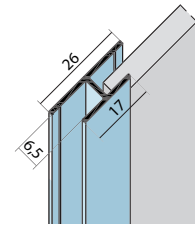

Item number	Material	Length (cm)	Order number	Color	Package/ Large pack
9736	Aluminum	300	110375	EV - E6 EV1	10 PCS / 130 BUN

Joint-H-profile vertical Alu EV1

Joint H-profile
for façade cladding of up to 8.5 mm.

Processing instructions: Only for vertical installation!

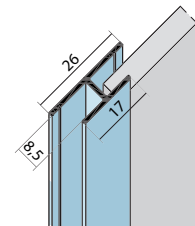

Item number	Material	Length (cm)	Order number	Color	Package/ Large pack
9738	Aluminum	300	110376	EV - E6 EV1	10 PCS / 130 BUN

Joint-H-profile vertical PVC

Joint H-profile
for façade cladding of up to 6.5 mm.

Processing instructions: Only for vertical installation!

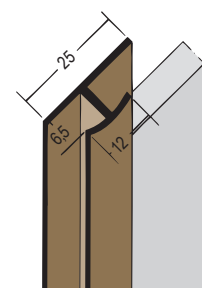
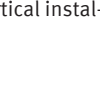

Item number	Material	Length (cm)	Order number	Color	Package/ Large pack
3557	Hard PVC	250	100621	47 - brown	20 PCS / 100 BUN
	Hard PVC	250	100618	10 - white	20 PCS / 100 BUN
	Hard PVC	250	100622	90 - black	20 PCS / 100 BUN

JOINT PROFILES

JOINT PROFILES VERTICAL

Joint-H-profile vertical PVC

Joint H-profile
for façade cladding of up to 6.5 mm.

Processing instructions: Only for vertical installation!

Notes:
Higher coverage and
greater movement absorption.

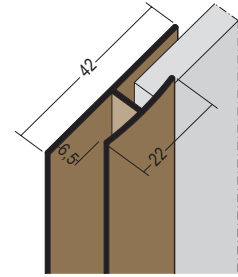

SALE
SALE

Item number	Material	Length (cm)	Order number	Color	Package/ Large pack
3558	Hard PVC	250	112411	10 - white	20 PCS / 75 BUN
	Hard PVC	250	112413	90 - black	20 PCS / 75 BUN

Joint-H-profile vertical PVC

Joint H-profile
for façade cladding of up to 8.5 mm.

Processing instructions: Only for vertical installation!

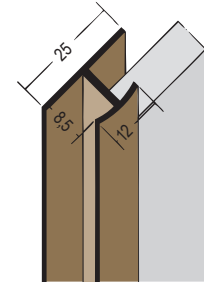

Item number	Material	Length (cm)	Order number	Color	Package/ Large pack
3546	Hard PVC	250	100504	90 - black	20 PCS / 81 BUN
	Hard PVC	250	100499	10 - white	20 PCS / 81 BUN

Joint-H-profile vertical PVC

Joint H-profile
for façade cladding of up to 10.5 mm.

Processing instructions: Only for vertical installation!

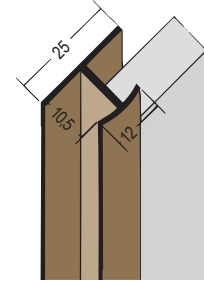

Item number	Material	Length (cm)	Order number	Color	Package/ Large pack
3547	Hard PVC	250	100512	10 - white	20 PCS / 90 BUN
	Hard PVC	250	100517	90 - black	20 PCS / 90 BUN

Joint-H-profile vertical PVC

Joint H-profile
for façade cladding of up to 12.5 mm.

Processing instructions: Only for vertical installation!

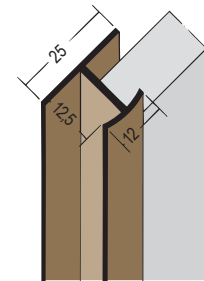

Item number	Material	Length (cm)	Order number	Color	Package/ Large pack
3548	Hard PVC	250	100526	10 - white	20 PCS / 64 BUN



INSTRUCTIONS FOR APPLICATION

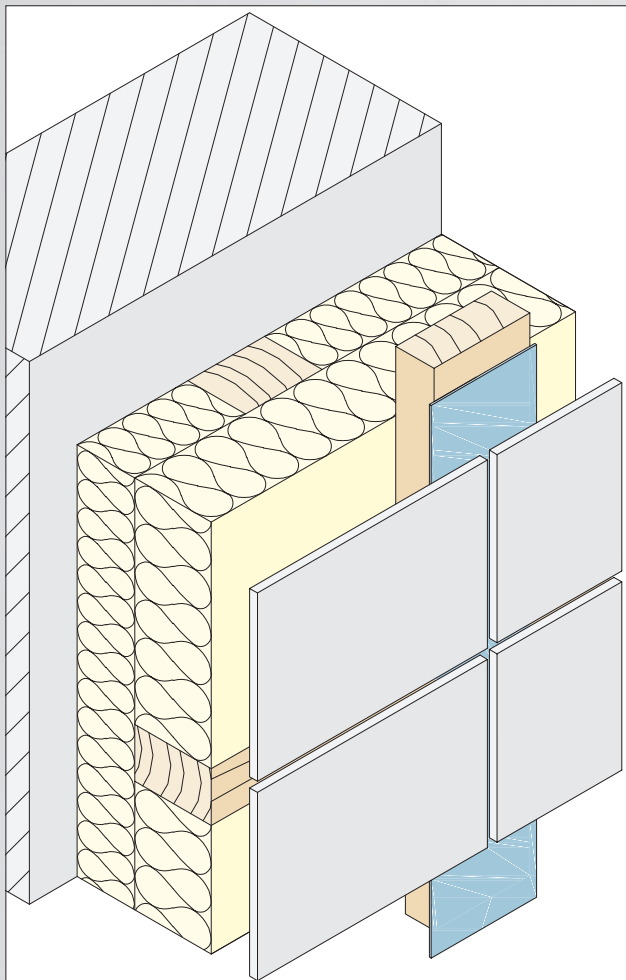

The joint tapes can be used for vertical joints and have different functions.

Joint tapes decouple the facade cladding and reduce noise transmission. They furthermore reduce water penetration and protect the substructure as well as the insulation from penetrating water.

For wooden substructures, the joint tape must overlap at least 5 mm on each side of the substructure.

PROTEKTOR joint tapes are made from aging-resistant and weather-resistant EPDM or soft PVC. The EPDM joint tapes significantly exceed the requirements of DIN 18516 Part 1 regarding temperature fluctuations and temperature limitations. Installation of the substructure is facilitated by the EPDM joint tapes with an adhesive foil, which is applied on site. Note: The adhesive foil increases the material thickness by approx. 0.2 mm.

PROTEKTOR recommends using joint tapes on wooden and aluminium substructures.

JOINT TAPES

JOINT TAPES EPDM

Joint tape EPDM black

EPDM joint tape for protecting sub-constructions.

Processing instructions: Install tension-free.
No overpainting possible.
Material thickness: 1,2 mm

Item number	Material	Length (cm)	Order number	Color	Dimension a (mm)	Package/ Large pack
3316	EPDM	2	115544	90 - black	80	3 ROL / 60 BOX
3317	EPDM	2	115543	90 - black	120	2 ROL / 60 BOX

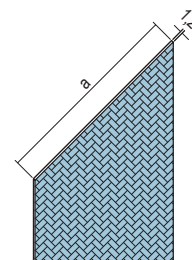

Joint tape EPDM black

EPDM joint tape for protecting sub-constructions.

Processing instructions: Install tension-free.
No overpainting possible.
Material thickness: 0,8 mm

Item number	Material	Length (cm)	Order number	Color	Dimension a (mm)	Package/ Large pack
3310	EPDM	2	108446	90 - black	70	3 ROL / 60 BOX
3311	EPDM	2	108447	90 - black	110	2 ROL / 60 BOX
3314	EPDM	2	110284	90 - black	130	2 ROL / 60 BOX

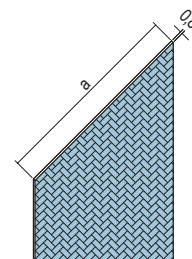

Joint tape EPDM self-adhesive black

Self-adhesive EPDM joint tape for protecting sub-constructions.

Processing instructions: Install tension-free.
No overpainting possible.
Material thickness: 0,8 mm

Item number	Material	Length (cm)	Order number	Color	Dimension a (mm)	Package/ Large pack
3312	EPDM sk	2	109790	90 - black	70	3 ROL / 60 BOX
3313	EPDM sk	2	109791	90 - black	110	2 ROL / 60 BOX
3315	EPDM sk	2	110285	90 - black	130	2 ROL / 60 BOX

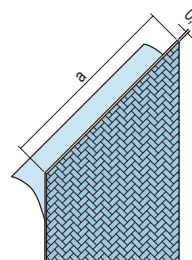

JOINT TAPES

JOINT TAPES PVC

Joint tape with sealing lip PVC

Joint tape made of flexible PVC with sealing lip for protecting sub-constructions.

Processing instructions: Install tension-free.
No overpainting possible.
Material thickness: 1,2 mm

Item number	Material	Length (cm)	Order number	Color	Dimension a (mm)	Package/ Large pack
3332	Soft PVC	2	100177	90 - black	36	2 ROL / 100 BOX

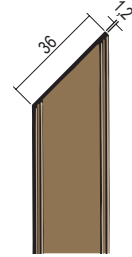

Joint tape with sealing lip PVC

Joint tape made of flexible PVC with sealing lip for protecting sub-constructions.

Processing instructions: Install tension-free.
No overpainting possible.
Material thickness: 1,2 mm

Item number	Material	Length (cm)	Order number	Color	Dimension a (mm)	Package/ Large pack
3333	Soft PVC	2	100181	90 - black	60	2 ROL / 48 BOX
	Soft PVC	2	100178	10 - white	60	2 ROL / 48 BOX

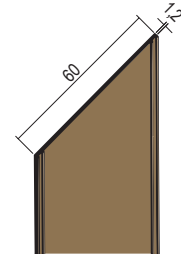

Joint tape with sealing lip PVC

Joint tape made of flexible PVC with sealing lip for protecting sub-constructions.

Processing instructions: Install tension-free.
No overpainting possible.
Material thickness: 1,2 mm

Item number	Material	Length (cm)	Order number	Color	Dimension a (mm)	Package/ Large pack
3334	Soft PVC	2	100185	90 - black	100	1 ROL / 48 BOX

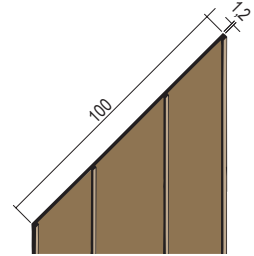

Joint tape with sealing lip PVC

Joint tape made of flexible PVC with a larger sealing lip for protecting sub-constructions.

Processing instructions: Install tension-free.
No overpainting possible.
Material thickness: 1,2 mm

Item number	Material	Length (cm)	Order number	Color	Dimension a (mm)	Package/ Large pack
3331	Weich-PVC	2	100173	90 - black	36	2 ROL / 100 BOX

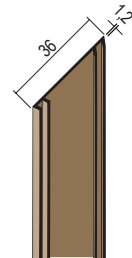

Joint tape with sealing lip PVC

Joint tape made of flexible PVC with sealing lip for protecting sub-constructions.

Processing instructions: Install tension-free.
No overpainting possible.
Material thickness: 1,2 mm

Item number	Material	Length (cm)	Order number	Color	Dimension a (mm)	Package/ Large pack
3327	Soft PVC	2	100156	90 - black	60	1 ROL / 100 BOX

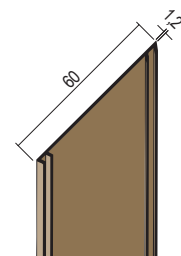

JOINT TAPES

JOINT TAPES PVC

Joint tape PVC

Joint tape made of flexible PVC for protecting sub-constructions.

Processing instructions: Install tension-free.
No overpainting possible.
Material thickness: 0,7 mm

Item number	Material	Length (cm)	Order number	Color	Dimension a (mm)	Package/ Large pack
3336	Soft PVC	5	100193	90 - black	110	1 ROL / 48 BOX

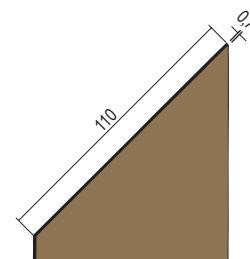

Joint tape PVC

Joint tape made of flexible PVC for protecting sub-constructions.

Processing instructions: Install tension-free.
No overpainting possible.
Material thickness: 0,5 mm

Notes:
Limited use.
In strong sunlight and under high load not suitable due to material thickness.

Item number	Material	Length (cm)	Order number	Color	Dimension a (mm)	Package/ Large pack
SALE 3326	Soft PVC	5	100148	10 - white	36	2 ROL / 100 BOX
3325	Soft PVC	5	100144	10 - white	60	2 ROL / 48 BOX
	Soft PVC	5	100147	90 - black	60	2 ROL / 48 BOX
3335	Soft PVC	5	100189	90 - black	80	1 ROL / 100 BOX
3322	Soft PVC	5	100135	90 - black	100	1 ROL / 100 BOX

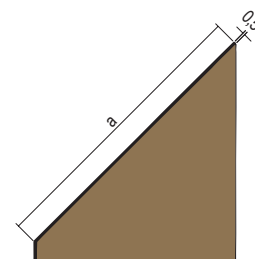

ANGLE PROFILES

Angle profile Alu

Angle profile 35 x 35 x 0.7 mm for various applications.

Material thickness (mm): 0,7 mm

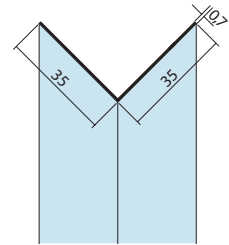

Item number	Material	Length (cm)	Order number	Description	Color	Package/ Large pack
9435	Aluminum	250	108215	35x35x0.7 mm	90 - black	20 PCS / 65 BUN

Angle profile Alu

Angle profile 50 x 50 x 0.8 mm for various applications.

Material thickness (mm): 0,8 mm

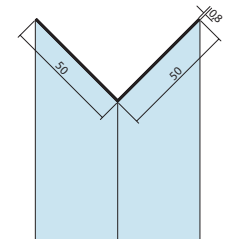

Item number	Material	Length (cm)	Order number	Description	Color	Package/ Large pack
9436	Aluminum	250	108216	50x50x0.8 mm	NA - natur	20 PCS / 65 BUN
9437	Aluminum	250	108208	50x50x0.8 mm	90 - black	20 PCS / 65 BUN

Angle profile

For universal uses.

Material: Galvanised steel

Material thickness (mm): 0,6 mm

Norm: EN 14195

Notes:

More dimensions of angle profiles upon request

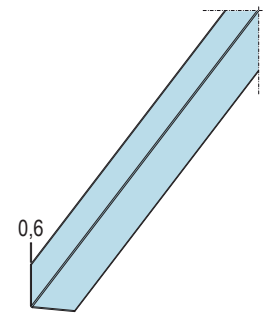

Item number	Material	Length (cm)	Order number	Description	Color	Package/ Large pack
5161	Galvanised steel	300	106601	28 x 28 mm		20 PCS / 50 BUN
5162	Galvanised steel	400	100654	41 x 41 mm		20 PCS / 50 BUN

Angle profile

For universal uses.

Material: Galvanised steel

Material thickness (mm): 0,7 mm

Norm: EN 14195

Notes:

More dimensions of angle profiles upon request

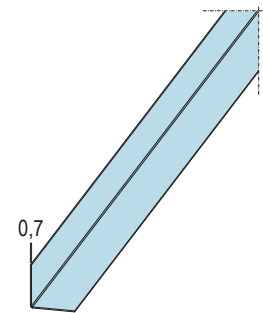

Item number	Material	Length (cm)	Order number	Description	Color	Package/ Large pack
5186	Galvanised steel	300	110249	30 x 50 mm		20 PCS / 55 BUN

Angle profile

For universal uses.

Material: Galvanised steel

Material thickness (mm): 1 mm

Norm: EN 14195

Notes:

More dimensions of angle profiles upon request

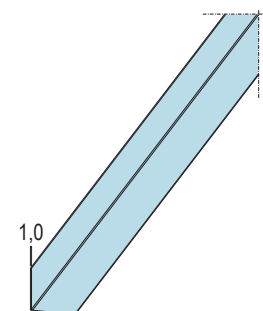

Item number	Material	Length (cm)	Order number	Description	Color	Package/ Large pack
5189	Galvanised steel	300	110251	30 x 30 mm		10 PCS / 50 BUN
5165	Galvanised steel	300	100663	40 x 20 mm		8 PCS / 60 BUN
5177	Galvanised steel	300	100723	40 x 40 mm		10 PCS / 50 BUN

ANGLE PROFILES

Angle profile PVC

15 x 20 x 1.5 mm angle profile for various applications.

Material thickness (mm): 1,5 mm

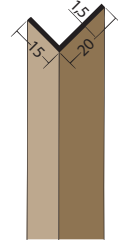

Item number	Material	Length (cm)	Order number	Description	Color	Package/ Large pack
3578	Hard PVC	250	100805	15x20x1.5 mm	10 - white	20 PCS / 230 BUN
	Hard PVC	250	100810	15x20x1.5 mm	90 - black	20 PCS / 230 BUN

Angle profile PVC

25 x 25 x 2.0 mm angle profile for various applications.

Material thickness (mm): 2 mm

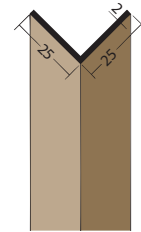

Item number	Material	Length (cm)	Order number	Description	Color	Package/ Large pack
3520	Hard PVC	250	100302	25x25x2.0 mm	90 - black	20 PCS / 135 BUN
	Hard PVC	250	100298	25x25x2.0 mm	10 - white	20 PCS / 135 BUN

Angle profile PVC

30 x 30 x 2.5 mm angle profile for various applications.

Material thickness (mm): 2,5 mm

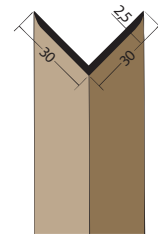

Item number	Material	Length (cm)	Order number	Description	Color	Package/ Large pack
3524	Hard PVC	250	100308	30x30x2.5 mm	10 - white	20 PCS / 84 BUN
	Hard PVC	250	100309	30x30x2.5 mm	33 - brick-red	20 PCS / 84 BUN
	Hard PVC	250	100310	30x30x2.5 mm	47 - brown	20 PCS / 84 BUN
	Hard PVC	250	100311	30x30x2.5 mm	90 - black	20 PCS / 84 BUN

Angle profile PVC

35 x 35 x 2.5 mm angle profile for various applications.

Material thickness (mm): 2,5 mm

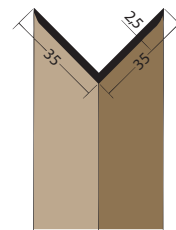

Item number	Material	Length (cm)	Order number	Description	Color	Package/ Large pack
3519	Hard PVC	250	100291	35x35x2.5 mm	90 - black	20 PCS / 84 BUN
	Hard PVC	250	100288	35x35x2.5 mm	10 - white	20 PCS / 84 BUN

Angle profile PVC

35 x 35 x 1.5 mm angle profile for various applications.

Material thickness (mm): 1,5 mm

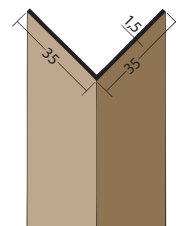

Item number	Material	Length (cm)	Order number	Description	Color	Package/ Large pack
3528	Hard PVC	250	100336	35x35x1.5 mm	10 - white	20 PCS / 99 BUN
	Hard PVC	250	100339	35x35x1.5 mm	90 - black	20 PCS / 99 BUN

ANGLE PROFILES

Angle profile PVC

30 x 60 x 2.0 mm angle profile for various applications.

Material thickness (mm): 2 mm

Item number	Material	Length (cm)	Order number	Description	Color	Package/ Large pack
3525	Hard PVC	250	100316	30x60x2.0 mm	10 - white	10 PCS / 97 BUN
	Hard PVC	250	100319	30x60x2.0 mm	90 - black	10 PCS / 97 BUN
	Hard PVC	250	100318	30x60x2.0 mm	47 - brown	10 PCS / 97 BUN

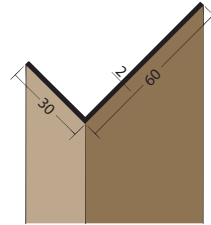

Angle profile PVC

30 x 90 x 2.5 mm angle profile for various applications.

Material thickness (mm): 2,5 mm

Item number	Material	Length (cm)	Order number	Description	Color	Package/ Large pack
3518	Hard PVC	250	100283	30x90x2.5 mm	90 - black	10 PCS / 59 BUN
	Hard PVC	250	100282	30x90x2.5 mm	47 - brown	10 PCS / 59 BUN
	Hard PVC	250	100280	30x90x2.5 mm	10 - white	10 PCS / 59 BUN

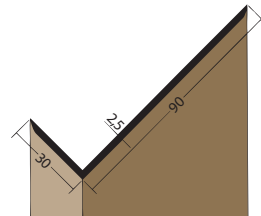

Angle profile PVC

65 x 65 x 1.5 mm angle profile for various applications.

Material thickness (mm): 1,5 mm

Item number	Material	Length (cm)	Order number	Description	Color	Package/ Large pack
3540	Hard PVC	250	100445	65x65x1,5 mm	90 - black	10 PCS / 75 BUN
	Hard PVC	250	100441	65x65x1,5 mm	10 - white	10 PCS / 75 BUN

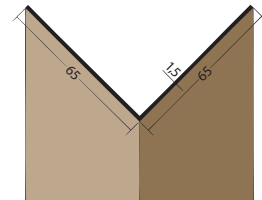



PROTEKTOR OMEGA-PROFILE – THE PERFECT CLIMATE FOR EVERY FACADE



The PROTEKTOR Omega ventilation profile (Art.-Nr. 9363) is a hat profile made of aluminium with ventilation holes. The height of the profile is 30 mm; the base is 60 mm wide. Ventilation holes with a diameter of 5 mm are placed along the profile. The free ventilation cross-section at the 30 mm leg is 75 cm²/running metre. The material thickness is 1 mm. The Protektor Omega ventilation profile is versatile.

NOTE: The Omega ventilation profile is not included in the building regulations list and has not been tested by DIBt for approval. The suitability of the Omega ventilation profile for the object must therefore be clarified on site in advance, in the planning phase or before installation.

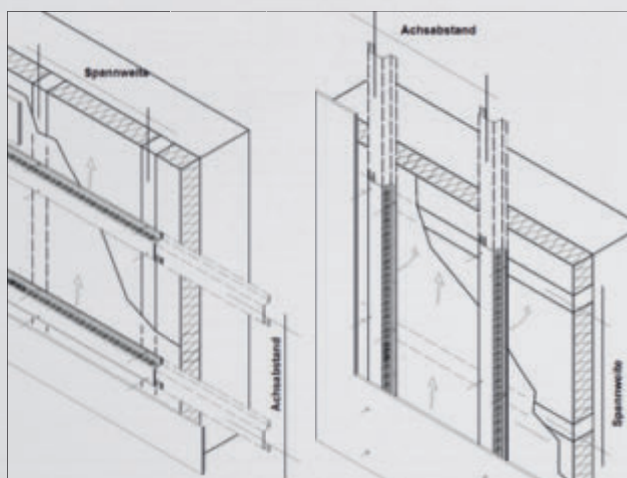

Product infos
View now »

OMEGA PROFILE

Omega-ventilation profile Alu

Hat profile with ventilation holes.

Material thickness: 1 mm
Product width: 60/110 mm
Height (b): 30 mm
Ventilation area: 75 cm²/lfm.

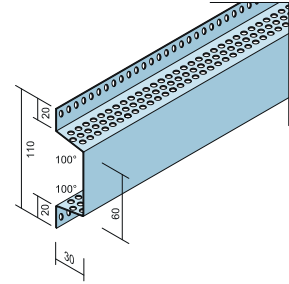

Item number	Material	Length (cm)	Order number	Color	Package/ Large pack
9363	Aluminum	300	111479	NA - natur	10 PCS / 42 BUN



GENERAL INFORMATION ABOUT ROOF AND FACADE VENTILATION

Ventilation profiles have the task of ensuring the greatest possible ventilation and the removal of moisture from the roof or the ventilated curtain wall and to achieve the best possible protection for small animals and insects at the same time.

According to DIN 4108 Part 3 a minimum ventilation cross section of 200 cm²/metre is required for an adequate roof ventilation for roof lengths up to 10 m.

According to DIN 18516 Part 1 the minimum cross section for the ventilation profile must be 50 cm²/metre and at least 200 cm²/metre for the rear ventilated area.

According to DIN 18516 Part 1, the openings in the base area for rear-ventilation of the exterior wall must be secured by ventilation grilles across a width of at least 20 mm.

The offset square perforation of the PROTEKTOR ventilation grilles ensures the highest possible percentage of holes. This improves ventilation up to approx. 20 % compared to most round or oval perforations.

Optimal and effective ventilation and moisture transportation by means of diffusion or condensation is therefore safer in the roof or the rear-ventilated curtain wall. At the same time, this blocks the access of unwanted small animals to the ventilation level.

Please pay particular attention to the minimum ventilation cross-sections when selecting ventilation profiles. See the respective profile information for the ventilation cross-section requirements. .

Ventilation profiles made of aluminium or PVC must be installed without constraint. It is therefore recommended that the profile is centred for fastening in the ventilation holes.

PROTEKTOR indicates the free ventilation cross sections in cm²/m as appropriate standards also indicate the required ventilation cross sections in cm²/m. This simplifies selection of the right profiles,

ROOF VENTILATION

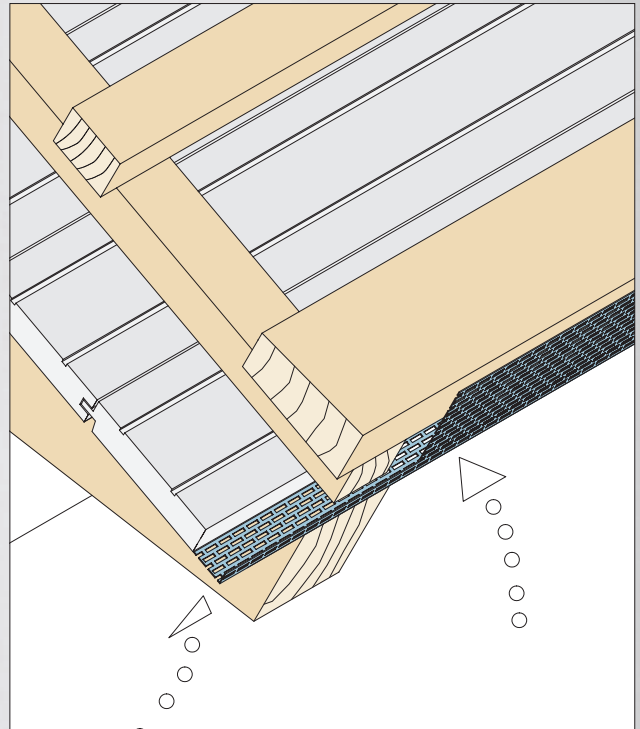
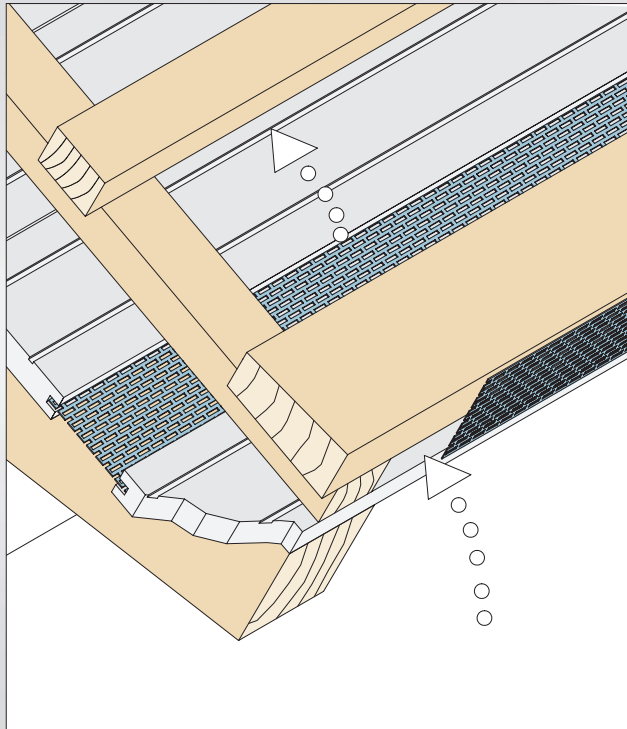

SOCKET FORMATION

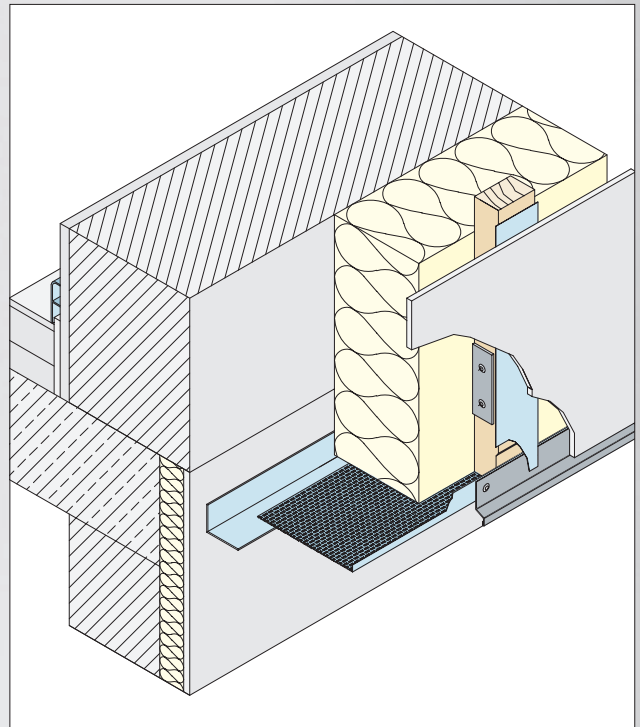
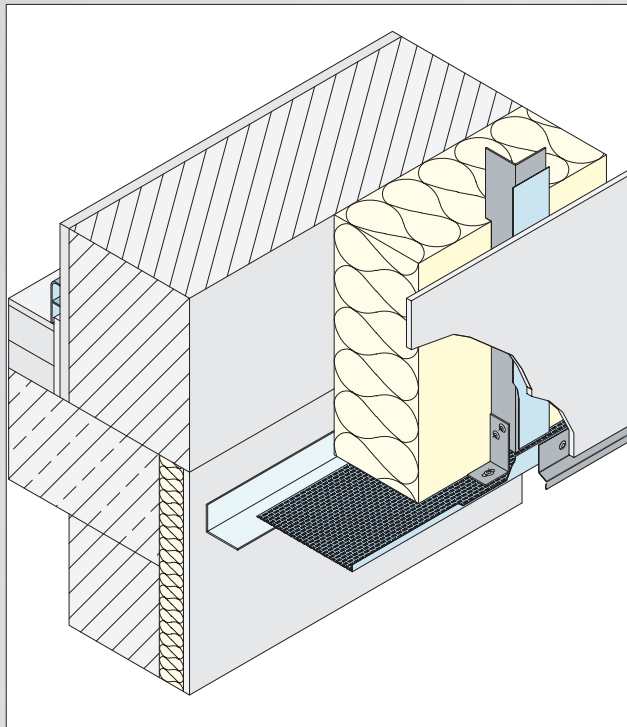

FACADE CONNECTION

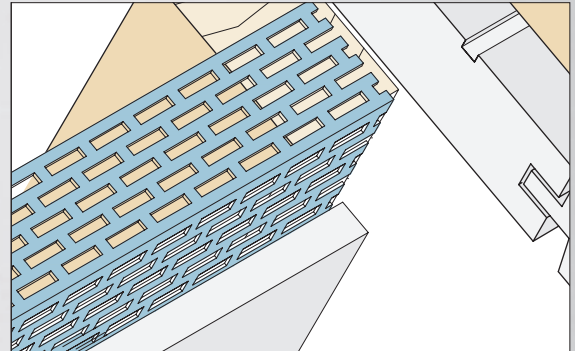
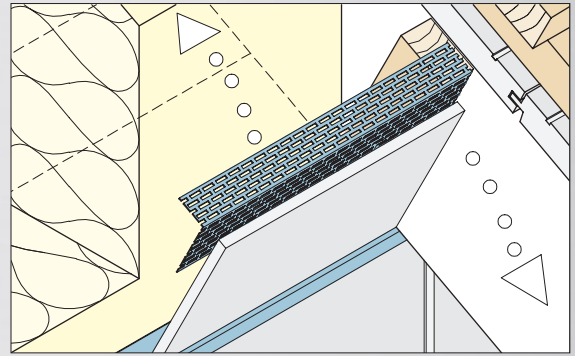
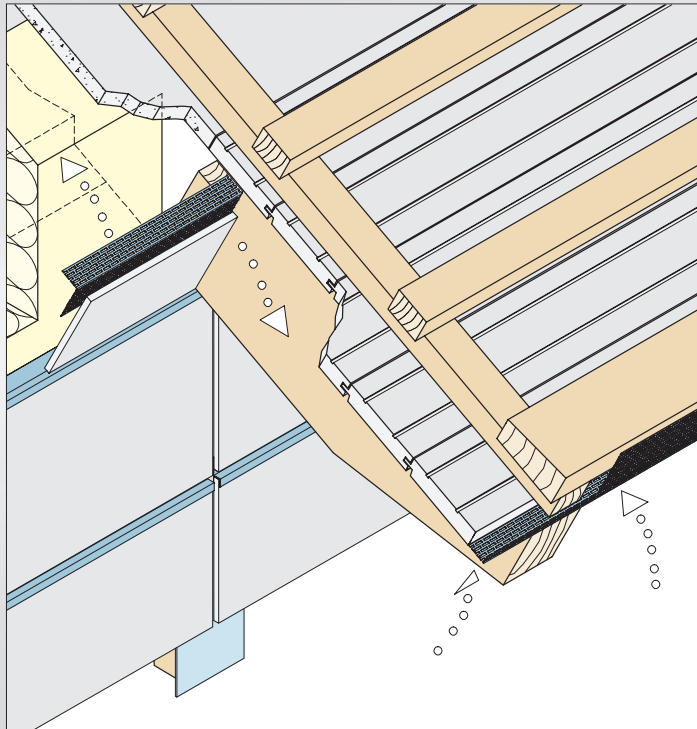

FACADE CONNECTION

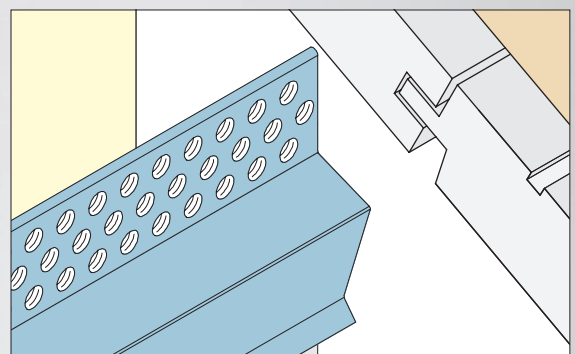
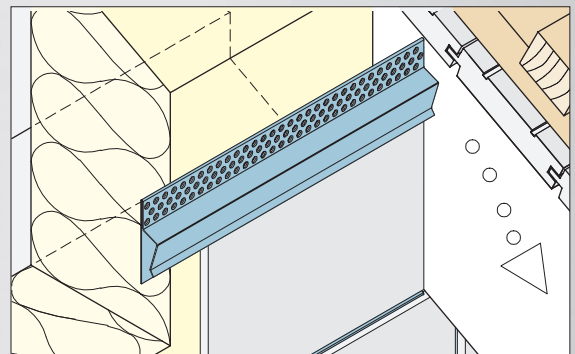
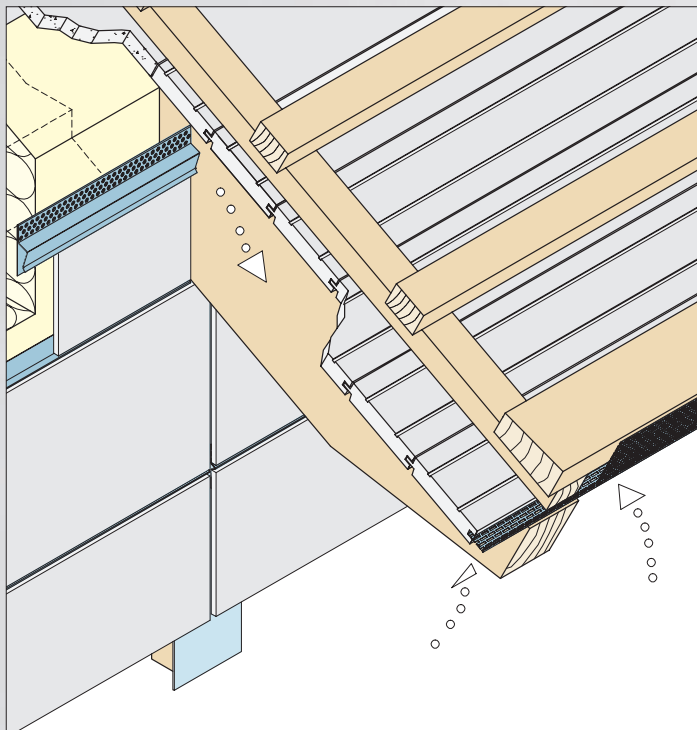

BASE FORMATION

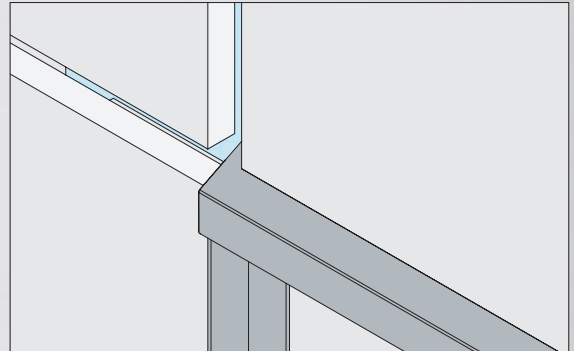
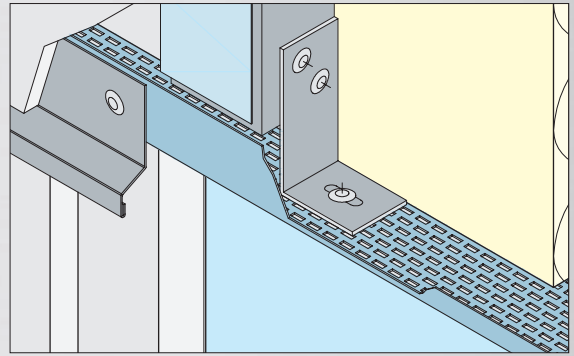
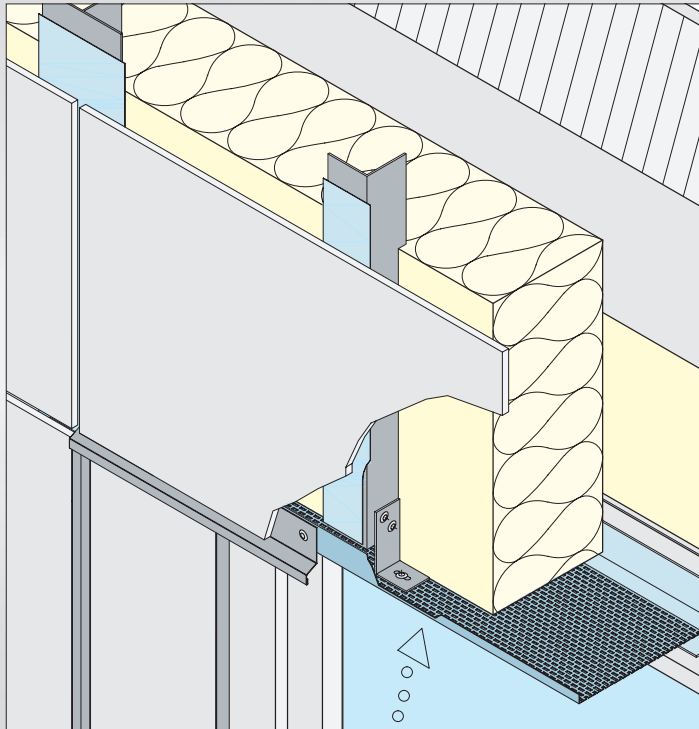

WINDOWSILL CONNECTION

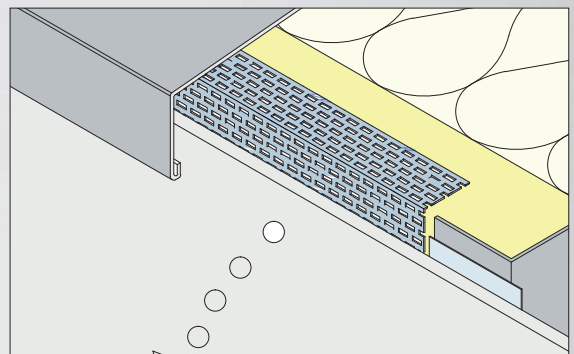
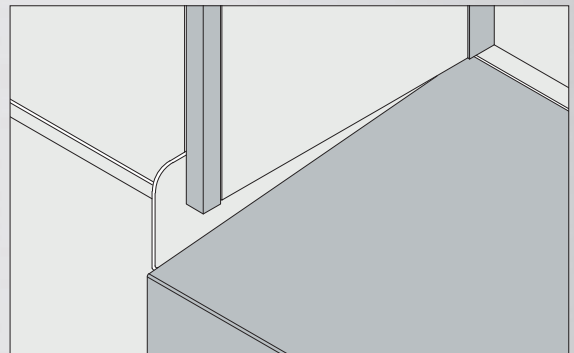
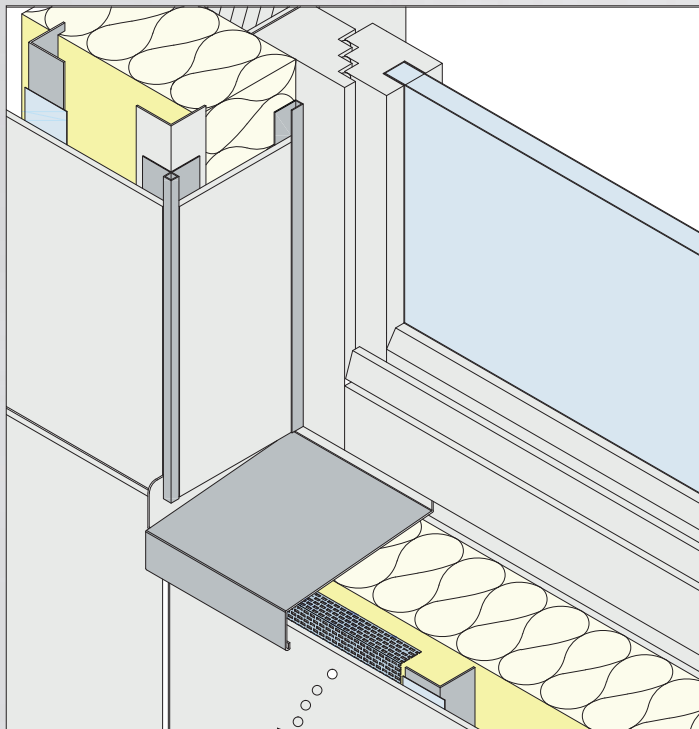

VENTILATION PROFILES

PROTEKTOR VENTILATION SYSTEM

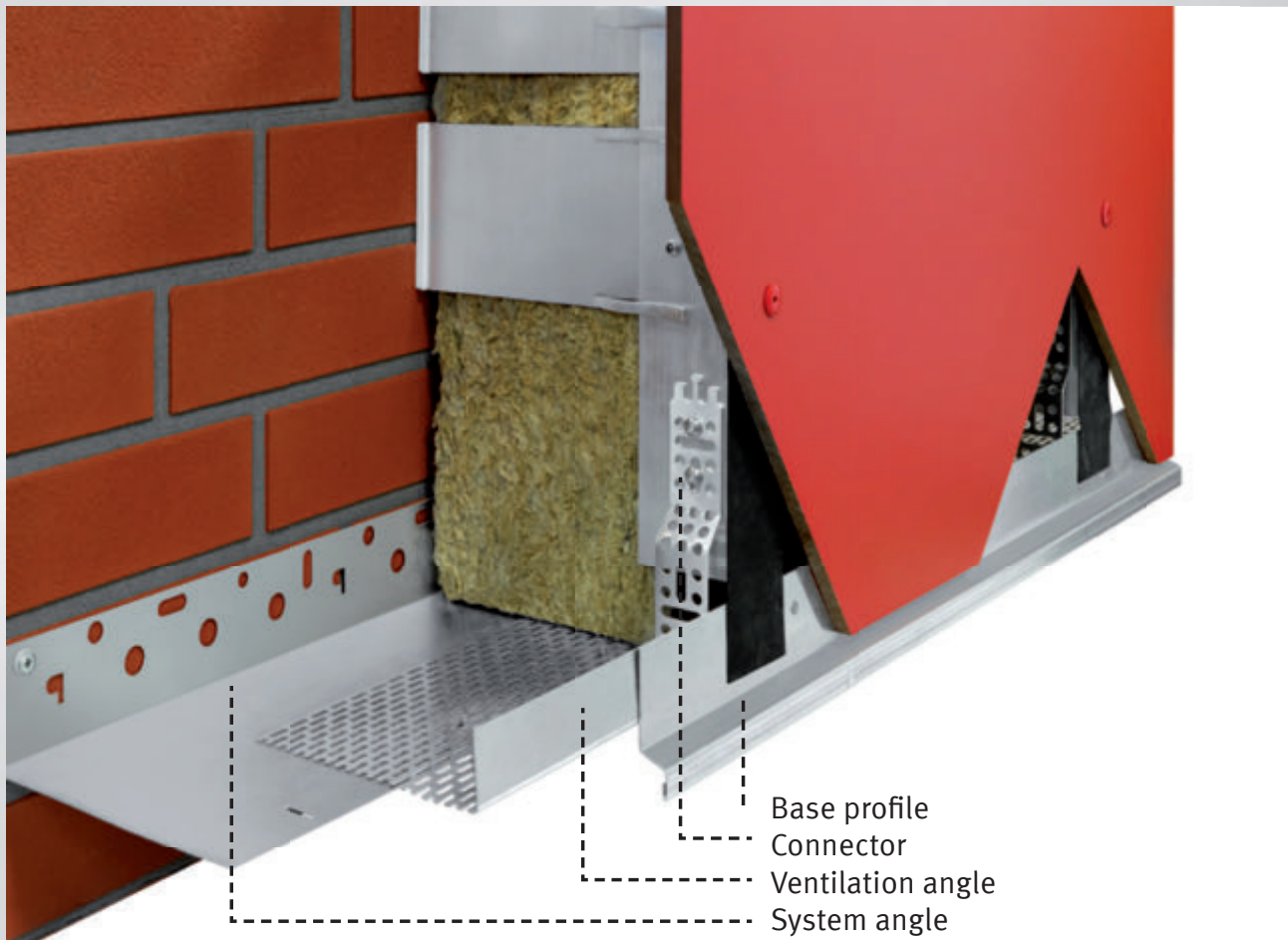

PROTEKTOR VENTILATION SYSTEM – THE PERFECT CLIMATE FOR EVERY FACADE



The new Protektor Ventilation System for rear-ventilated curtain facades is easy to use and provides long-lasting quality. It is the very first ventilation system that utilises a connector to ensure tension-free installation that conforms to the DIN norms. Another advantage is the continuous width adjustability offered by this system. Various widths can be achieved using just two profiles, the system and the ventilation angle. The angles can simply be connected using rivets, without the need for prior drilling. The connector prevents the substructure from warping and eliminates the onset of damage.

These are the advantages of the PROTEKTOR Ventilation System:

- ▶ Ensures tension-free installation using a connector
- ▶ Conforms to DIN 18516-1, 4.3, rear-ventilated exterior wall cladding
- ▶ Expansion allowance of the ventilation angle with respect to the substructure
- ▶ Substructure does not warp
- ▶ Eliminates the onset of damage
- ▶ System and ventilation angle allow for continuous adjustment
- ▶ Various widths can be achieved using just two profiles
- ▶ Convenient riveting of ventilation and system angle without the need for pre-drilling
- ▶ Ideal for creating base profiles, door and window lintels

PROTEKTOR-LÜFTUNGSSYSTEM (PLS)
PRIMA KLIMA FÜR JEDE FASSADE

NEU

Einzigartige Verbindung und neue
KONNEKTOR-Systeme ermöglichen die neue
PLS die verriegelte Verbindung
zu gewährleisten. Die Lösung ist hier
einzigartig und garantiert einen
einheitlichen, sicheren und
dauerhaften Anschluss.
Eine weitere Besonderheit ist die
Anpassungsfähigkeit des Systems
an unterschiedliche Substrukturen.
Das System ist leicht zu montieren
und ermöglicht eine schnelle
Anpassung an unterschiedliche
Substrukturen. Die Lösung ist hier
einzigartig und garantiert einen
einheitlichen, sicheren und
dauerhaften Anschluss.

Justierbar und verriegelbar mit PLS- als Vergleich

Das zeichnet das PROTEKTOR-LÜFTUNGSSYSTEM aus:

- ▶ Einzigartige Verbindung und neue KONNEKTOR-Systeme ermöglichen die neue PLS die verriegelte Verbindung zu gewährleisten.
- ▶ Anpassungsfähigkeit des Systems an unterschiedliche Substrukturen.
- ▶ Leicht zu montieren und ermöglicht eine schnelle Anpassung an unterschiedliche Substrukturen.
- ▶ Einheitlicher, sicherer und dauerhafter Anschluss.
- ▶ Einzigartige Verbindung und neue KONNEKTOR-Systeme ermöglichen die neue PLS die verriegelte Verbindung zu gewährleisten.
- ▶ Anpassungsfähigkeit des Systems an unterschiedliche Substrukturen.
- ▶ Leicht zu montieren und ermöglicht eine schnelle Anpassung an unterschiedliche Substrukturen.
- ▶ Einheitlicher, sicherer und dauerhafter Anschluss.

www.protektor.com



VENTILATION PROFILES COMPARISON

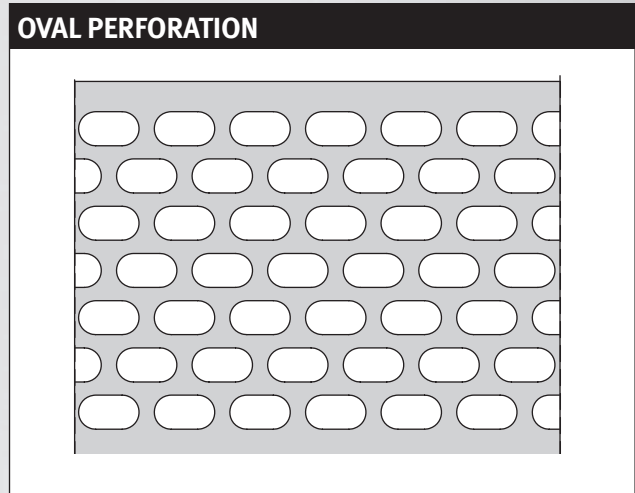
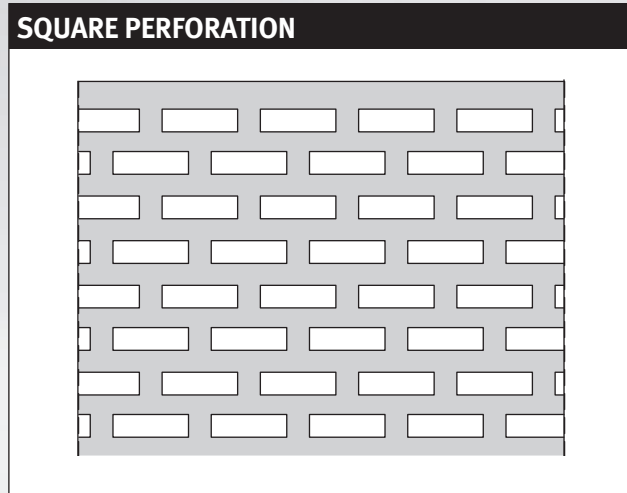

Hole geometry	PVC Strip 3 x 6 mm	PVC Strip 4,5 x 8 mm
	PVC Angles 3 x 6 mm	PVC Angles 4,5 x 8 mm
	Alu Strip 3 x 10 mm	Alu Strip 4,5 x 8 mm
	Alu Angles 3 x 10 mm	Alu Angles 3,6 x 7,2 mm
Small animal protection	Yes	Yes
Insect protection	Yes, up to small insects	Yes, up to medium insects
Design	Holes expand lengthwise	Holes expand widthwise

Examples of free ventilation cross sections

PVC-Ventilation strip 80 mm	426 cm ² /lfm	378 cm ² /lfm
Alu-Ventilation strip 80 mm	300 cm ² /lfm	378 cm ² /lfm
PVC-Ventilation angle 30 x 50 mm	246 cm ² /lfm Perforated on one side	220 cm ² /lfm Perforated on one side
Alu-Ventilation angle 30 x 50 mm	92/185 cm ² /lfm Perforated on both sides	126/252 cm ² /lfm Perforated on both sides
PVC-Ventilation angle 30 x 90 mm	470 cm ² /lfm Perforated on one side	410 cm ² /lfm Perforated on one side
Alu-Ventilation angle 30 x 90 mm	346 cm ² /lfm Perforated on both sides	126/441 cm ² /lfm Perforated on both sides

PROTEKTOR VENTILATION SYSTEM (PLS)

Connector Alu

Connector for the PROTEKTOR ventilation system (PLS).



Item number	Material	Length (cm)	Order number	Color	Package/ Large pack
9471	Aluminum	11	109533	NA - natur	50 PC / 999 BOX

System angle Alu

System angle 48 x 140 mm for the PROTEKTOR ventilation system (PLS).

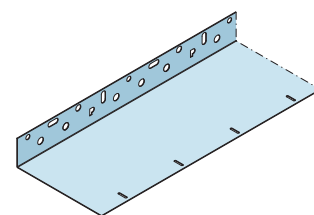

Item number	Material	Length (cm)	Order number	Color	Package/ Large pack
9472	Aluminum	250	109529	NA - natur	10 PCS / 30 BUN

Ventilation angle one-sided square perforation Alu

Ventilation angle 30 x 120 mm with single-sided square perforation.

Ventilation area: 462 cm²/lfm.

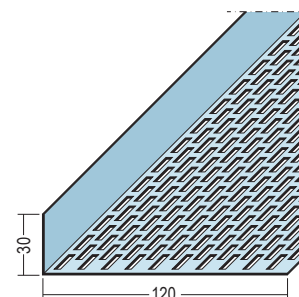

Item number	Material	Length (cm)	Order number	Color	Package/ Large pack
9334	Aluminum	250	107031	NA - natur	10 PCS / 83 BUN
9335	Aluminum	250	107034	90 - black	10 PCS / 83 BUN

Socle profile-Z Alu

Wall base z-profile for covering facade cladding of up to 11.5 mm.

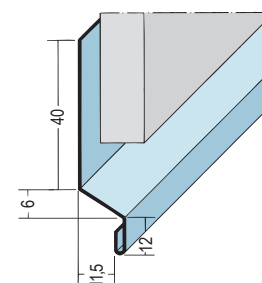

Item number	Material	Length (cm)	Order number	Color	Dimension a (mm)	Package/ Large pack
9083	Aluminum	250	101622	NA - natur	11,5 mm	10 PCS / 140 BUN

VENTILATION PROFILES

VENTILATION STRIP WITH SQUARE PERFORATION

Ventilation angle double-sided square perforation Alu

Ventilation angle 30 x 30 mm with double-sided square perforation.

Ventilation area: 92/92 cm²/lfm.

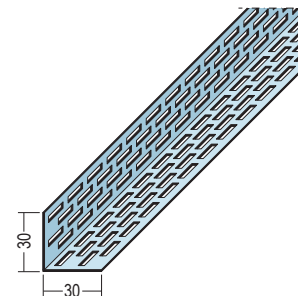

Item number	Material	Length (cm)	Order number	Color	Package/ Large pack
9309	Aluminum	250	112034	NA - natur	20 PCS / 198 BUN

Ventilation angle double-sided square perforation Alu

Ventilation angle 30 x 40 mm with double-sided square perforation.

Ventilation area: 92/139 cm²/lfm.

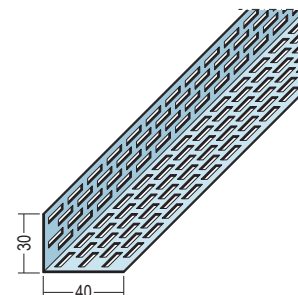

Item number	Material	Length (cm)	Order number	Color	Package/ Large pack
9301	Aluminum	250	101677	NA - natur	20 PCS / 168 BUN
9300	Aluminum	250	101674	90 - black	20 PCS / 168 BUN

Ventilation angle double-sided square perforation Alu

Ventilation angle 30 x 50 mm with double-sided square perforation.

Ventilation area: 92/185 cm²/lfm.

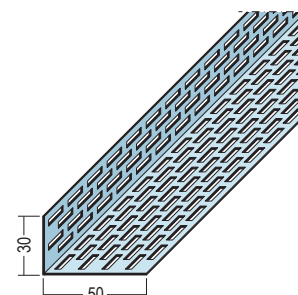

Item number	Material	Length (cm)	Order number	Color	Package/ Large pack
9071	Aluminum	250	112035	NA - natur	20 PCS / 144 BUN
9043	Aluminum	250	101193	90 - black	20 PCS / 144 BUN

Ventilation angle one-sided square perforation Alu

Ventilation angle 30 x 60 mm with single-sided square perforation.

Ventilation area: 208 cm²/lfm.

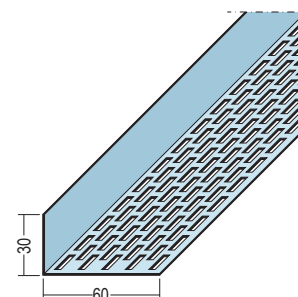

Item number	Material	Length (cm)	Order number	Color	Package/ Large pack
9330	Aluminum	250	107029	NA - natur	10 PCS / 165 BUN
9331	Aluminum	250	107032	90 - black	10 PCS / 165 BUN

Ventilation angle one-sided square perforation Alu

Ventilation angle 30 x 70 mm with single-sided square perforation.

Ventilation area: 254 cm²/lfm.

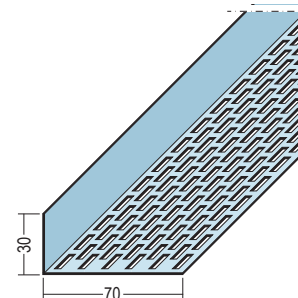

Item number	Material	Length (cm)	Order number	Color	Package/ Large pack
9072	Aluminum	250	112036	NA - natur	20 PCS / 108 BUN
9044	Aluminum	250	101197	90 - black	20 PCS / 108 BUN

VENTILATION PROFILES

VENTILATION STRIP WITH SQUARE PERFORATION

Ventilation angle one-sided square perforation Alu

Ventilation angle 30 x 90 mm with single-sided square perforation.

Ventilation area: 346 cm²/lfm.



Item number	Material	Length (cm)	Order number	Color	Package/ Large pack
9306	Aluminum	250	112037	NA - natur	20 PCS / 84 BUN

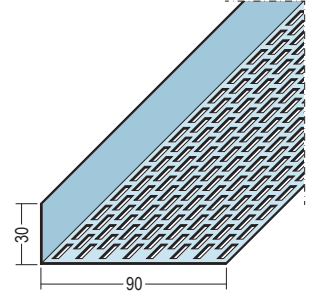

Ventilation angle one-sided square perforation Alu

Ventilation angle 30 x 100 mm with single-sided square perforation.

Ventilation area: 393 cm²/lfm.



Item number	Material	Length (cm)	Order number	Color	Package/ Large pack
9332	Aluminum	250	107030	NA - natur	10 PCS / 100 BUN
9333	Aluminum	250	107033	90 - black	10 PCS / 100 BUN

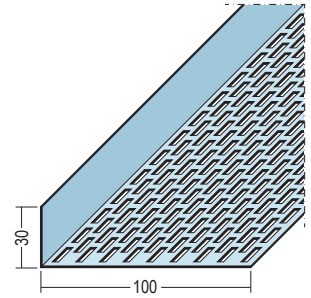

Ventilation angle one-sided square perforation Alu

Ventilation angle 30 x 120 mm with single-sided square perforation.

Ventilation area: 462 cm²/lfm.



Item number	Material	Length (cm)	Order number	Color	Package/ Large pack
9334	Aluminum	250	107031	NA - natur	10 PCS / 83 BUN
9335	Aluminum	250	107034	90 - black	10 PCS / 83 BUN

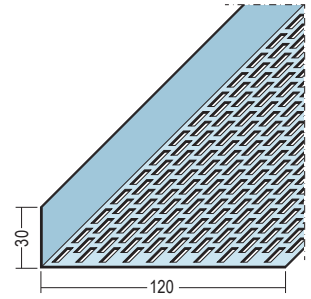

Ventilation angle double-sided square perforation Alu

Ventilation angle 50 x 50 mm with double-sided square perforation.

Ventilation area: 185/185 cm²/lfm.



Item number	Material	Length (cm)	Order number	Color	Package/ Large pack
9073	Aluminum	250	101611	NA - natur	20 PCS / 99 BUN
9046	Aluminum	250	101204	90 - black	20 PCS / 80 BUN

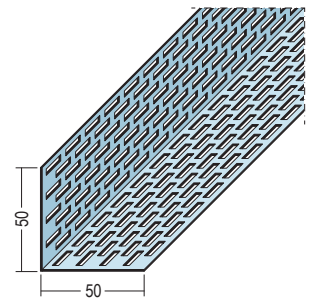

Ventilation angle double-sided square perforation Alu

Ventilation angle 50 x 70 mm with double-sided square perforation.

Ventilation area: 185/255 cm²/lfm.



Item number	Material	Length (cm)	Order number	Color	Package/ Large pack
9302	Aluminum	250	101680	NA - natur	20 PCS / 72 BUN
9303	Aluminum	250	101681	90 - black	20 PCS / 72 BUN

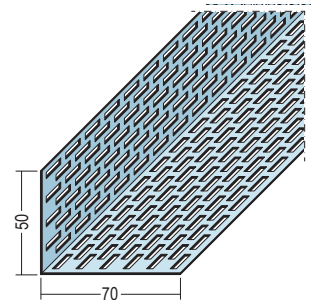

VENTILATION PROFILES

VENTILATION STRIP WITH SQUARE PERFORATION

Ventilation angle one-sided square perforation Alu

Ventilation angle 10 x 50 mm with single-sided square perforation.

Ventilation area: 185 cm²/lfm.

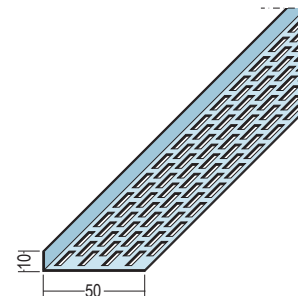

Item number	Material	Length (cm)	Order number	Color	Package/ Large pack
9312	Aluminum	250	103539	NA - natur	20 PCS / 163 BUN

Ventilation angle one-sided square perforation Alu

Ventilation angle 10 x 70 mm with single-sided square perforation.

Ventilation area: 254 cm²/lfm.

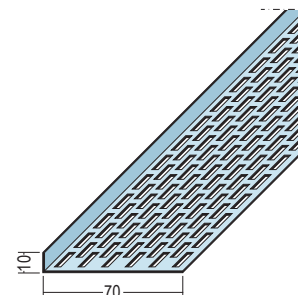

Item number	Material	Length (cm)	Order number	Color	Package/ Large pack
9313	Aluminum	250	103538	NA - natur	20 PCS / 180 BUN

Ventilation angle one-sided square perforation Alu

Ventilation angle 10 x 90 mm with single-sided square perforation.

Ventilation area: 346 cm²/lfm.

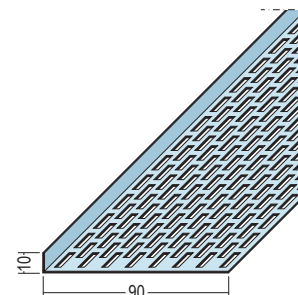

Item number	Material	Length (cm)	Order number	Color	Package/ Large pack
9314	Aluminum	250	103537	NA - natur	20 PCS / 147 BUN

Ventilation angle one-sided square perforation PVC

Ventilation angle 25 x 25 mm with single-sided square perforation.

Ventilation area: 112 cm²/lfm.

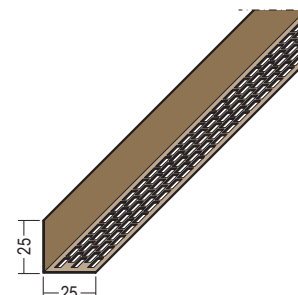

Item number	Material	Length (cm)	Order number	Color	Package/ Large pack
3614	Hard PVC	250	101105	47 - brown	20 PCS / 160 BUN
	Hard PVC	250	101107	90 - black	20 PCS / 160 BUN
	Hard PVC	250	101098	10 - white	20 PCS / 160 BUN

Ventilation angle one-sided square perforation PVC

Ventilation angle 30 x 30 mm with single-sided square perforation.

Ventilation area: 134 cm²/lfm.

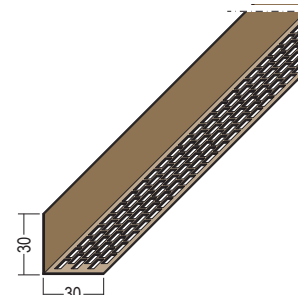

Item number	Material	Length (cm)	Order number	Color	Package/ Large pack
3612	Hard PVC	250	112030	90 - black	20 PCS / 140 BUN
	Hard PVC	250	112028	10 - white	20 PCS / 140 BUN
	Hard PVC	250	112029	47 - brown	20 PCS / 140 BUN

VENTILATION PROFILES

VENTILATION STRIP WITH SQUARE PERFORATION

Ventilation angle one-sided square perforation PVC

Ventilation angle 30 x 50 mm
with single-sided square perforation.

Ventilation area: 246 cm²/lfm.

Item number	Material	Length (cm)	Order number	Color	Package/ Large pack
3610	Hard PVC	250	112026	47 - brown	20 PCS / 80 BUN
	Hard PVC	250	112025	10 - white	20 PCS / 80 BUN
	Hard PVC	250	112027	90 - black	20 PCS / 80 BUN
	Hard PVC	250	101030	33 - brick-red	20 PCS / 80 BUN

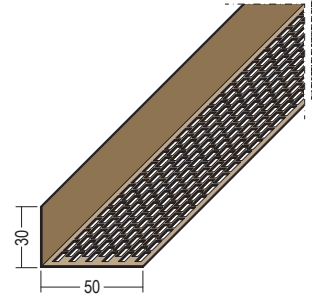

Ventilation angle one-sided square perforation PVC

Ventilation angle 30 x 60 mm
with single-sided square perforation.

Ventilation area: 291 cm²/lfm.

Item number	Material	Length (cm)	Order number	Color	Package/ Large pack
3611	Hard PVC	250	101050	90 - black	10 PCS / 120 BUN
	Hard PVC	250	101048	47 - brown	10 PCS / 120 BUN
	Hard PVC	250	101046	33 - brick-red	10 PCS / 120 BUN
	Hard PVC	250	101043	10 - white	10 PCS / 120 BUN

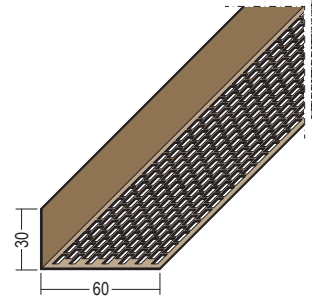

Ventilation angle one-sided square perforation PVC

Ventilation angle 30 x 70 mm
with single-sided square perforation.

Ventilation area: 358 cm²/lfm.

Item number	Material	Length (cm)	Order number	Color	Package/ Large pack
3613	Hard PVC	250	112031	10 - white	10 PCS / 117 BUN
	Hard PVC	250	101083	33 - brick-red	10 PCS / 117 BUN
	Hard PVC	250	112033	90 - black	10 PCS / 117 BUN
	Hard PVC	250	112032	47 - brown	10 PCS / 117 BUN

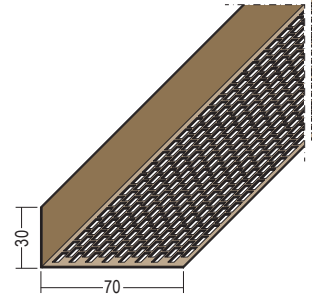

Ventilation angle one-sided square perforation PVC

Ventilation angle 30 x 90 mm
with single-sided square perforation.

Ventilation area: 470 cm²/lfm.

Item number	Material	Length (cm)	Order number	Color	Package/ Large pack
3617	Hard PVC	250	101122	33 - brick-red	10 PCS / 77 BUN
	Hard PVC	250	101127	90 - black	10 PCS / 77 BUN
	Hard PVC	250	101125	47 - brown	10 PCS / 77 BUN
	Hard PVC	250	101119	10 - white	10 PCS / 77 BUN

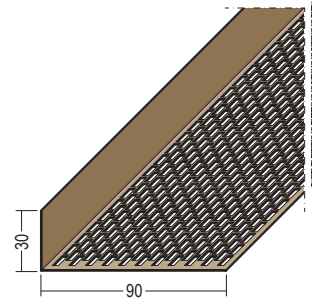

VENTILATION PROFILES

VENTILATION STRIP WITH SQUARE PERFORATION ALU

Ventilation strip square perforation Alu

50-mm ventilation strip with square perforations.

Ventilation area: 185 cm²/lfm.



Item number	Material	Length (cm)	Order number	Color	Package/ Large pack
9320	Aluminum	250	107023	NA - natur	20 PCS / 196 BUN
9321	Aluminum	250	107026	90 - black	20 PCS / 132 BUN

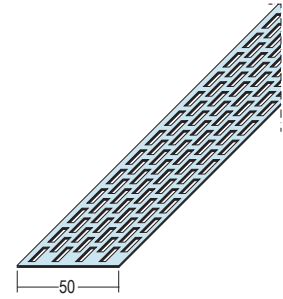

Ventilation strip square perforation Alu

70-mm ventilation strips with square perforations.

Ventilation area: 254 cm²/lfm.



Item number	Material	Length (cm)	Order number	Color	Package/ Large pack
9040	Aluminum	250	101184	NA - natur	20 PCS / 140 BUN
9041	Aluminum	250	101188	90 - black	20 PCS / 140 BUN

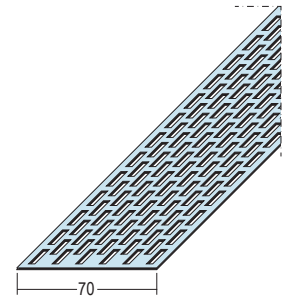

Ventilation strip square perforation Alu

80-mm ventilation strip with square perforations.

Ventilation area: 300 cm²/lfm.



Item number	Material	Length (cm)	Order number	Color	Package/ Large pack
9322	Aluminum	250	107024	NA - natur	20 PCS / 95 BUN
9323	Aluminum	250	107027	90 - black	20 PCS / 119 BUN

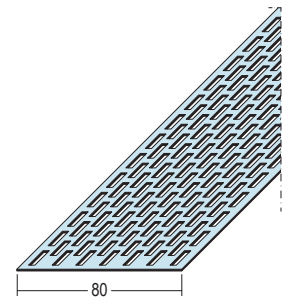

Ventilation strip square perforation Alu

100-mm ventilation strips with square perforations.

Ventilation area: 393 cm²/lfm.



Item number	Material	Length (cm)	Order number	Color	Package/ Large pack
9324	Aluminum	250	107025	NA - natur	20 PCS / 98 BUN
9325	Aluminum	250	107028	90 - black	20 PCS / 98 BUN

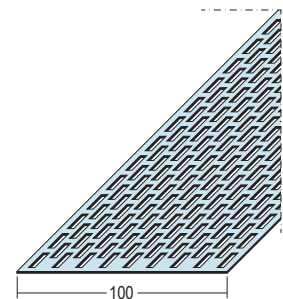

Ventilation strip square perforation Alu

120-mm ventilation strip with square perforations.

Ventilation area: 462 cm²/lfm.



Item number	Material	Length (cm)	Order number	Color	Package/ Large pack
9095	Aluminum	250	101670	NA - natur	20 PCS / 84 BUN
9096	Aluminum	250	101671	90 - black	20 PCS / 63 BUN

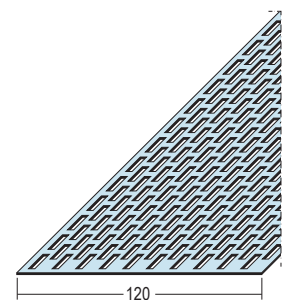

VENTILATION PROFILES

VENTILATION STRIP WITH SQUARE PERFORATION ALU

Ventilation strip square perforation rolled Alu

50-mm rolled ventilation strips in a convenient dispenser case.

Ventilation area: 185 cm²/lfm.

Item number	Material	Length (cm)	Order number	Color	Package/ Large pack
9340	Aluminum	6	108736	NA - natur	2 ROL / 46 BOX
9344	Aluminum	6	108739	97 - white/brown	2 ROL / 46 BOX
9348	Aluminum	6	109167	98 - black/red	2 ROL / 46 BOX



Ventilation strip square perforation rolled Alu

80-mm rolled ventilation strips in a convenient dispenser.

Ventilation area: 300 cm²/lfm.

Item number	Material	Length (cm)	Order number	Color	Package/ Large pack
9341	Aluminum	6	108737	NA - natur	1 ROL / 46 BOX
9345	Aluminum	6	108740	97 - white/brown	1 ROL / 46 BOX
9349	Aluminum	6	109168	98 - black/red	1 ROL / 46 BOX



Ventilation strip square perforation rolled Alu

100-mm ventilation strips in a convenient dispenser case.

Ventilation area: 393 cm²/lfm.

Item number	Material	Length (cm)	Order number	Color	Package/ Large pack
9342	Aluminum	6	108738	NA - natur	1 ROL / 46 BOX
9346	Aluminum	6	108741	97 - white/brown	1 ROL / 46 BOX
9350	Aluminum	6	109169	98 - black/red	1 ROL / 46 BOX



VENTILATION PROFILES

VENTILATION STRIP SQUARE PERFORATION PVC

Ventilation strip square perforated rolled PVC

50-mm rolled ventilation strips with square perforations.

Ventilation area: 269 cm²/lfm.

Item number	Material	Length (cm)	Order number	Color	Package/ Large pack
3686	Hard PVC	500	102036	10 - white	24 ROL / 40 BOX
	Hard PVC	500	102047	47 - brown	24 ROL / 40 BOX
	Hard PVC	500	102051	90 - black	24 ROL / 40 BOX
3677	Hard PVC	6	101893	47 - brown	2 ROL / 46 BOX
	Hard PVC	6	101861	10 - white	2 ROL / 46 BOX
	Hard PVC	6	101895	90 - black	2 ROL / 46 BOX

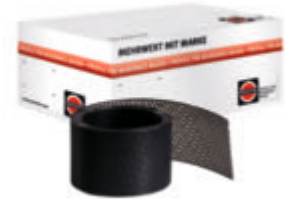

Ventilation strip square perforated rolled PVC

80-mm rolled ventilation strips with square perforations.

Ventilation area: 426 cm²/lfm.

Item number	Material	Length (cm)	Order number	Color	Package/ Large pack
3685	Hard PVC	500	102017	10 - white	12 ROL / 40 BOX
	Hard PVC	500	102033	90 - black	12 ROL / 40 BOX
	Hard PVC	500	102020	33 - brick-red	12 ROL / 40 BOX
	Hard PVC	500	102029	47 - brown	12 ROL / 40 BOX
3678	Hard PVC	6	101908	47 - brown	1 ROL / 46 BOX
	Hard PVC	6	101896	10 - white	1 ROL / 46 BOX
	Hard PVC	6	101911	90 - black	1 ROL / 46 BOX

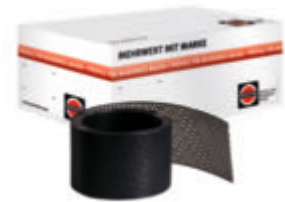

Ventilation strip square perforation rolled PVC

100-mm rolled ventilation strips with square perforations.

Ventilation area: 538 cm²/lfm.

Item number	Material	Length (cm)	Order number	Color	Package/ Large pack
3681	Hard PVC	500	101953	47 - brown	12 ROL / 40 BOX
	Hard PVC	500	101931	10 - white	12 ROL / 40 BOX
	Hard PVC	500	101958	90 - black	12 ROL / 40 BOX
	Hard PVC	500	101940	33 - brick-red	12 ROL / 40 BOX
3679	Hard PVC	6	101926	33 - brick-red	1 ROL / 46 BOX
	Hard PVC	6	101930	47 - brown	1 ROL / 46 BOX
	Hard PVC	6	101916	10 - white	1 ROL / 46 BOX
	Hard PVC	6	101933	90 - black	1 ROL / 46 BOX

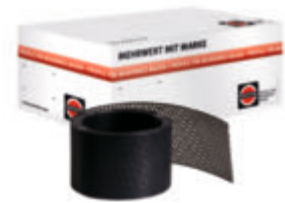

Ventilation strip square perforated rolled PVC

150-mm rolled ventilation strips with square perforations.

Ventilation area: 648 cm²/lfm.

Item number	Material	Length (cm)	Order number	Color	Package/ Large pack
3682	Hard PVC	500	101981	47 - brown	12 ROL / 24 BOX
	Hard PVC	500	101965	10 - white	12 ROL / 24 BOX
	Hard PVC	500	102000	90 - black	12 ROL / 24 BOX
	Hard PVC	500	101970	33 - brick-red	12 ROL / 24 BOX

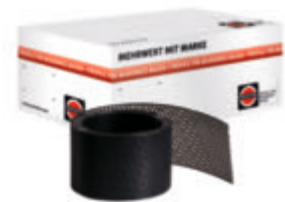

VENTILATION PROFILES

VENTILATION STRIP SQUARE PERFORATION PVC

Ventilation strip square perforation rolled PVC

180-mm rolled ventilation strips with square perforations.

Ventilation area: 792 cm²/lfm.

Item number	Material	Length (cm)	Order number	Color	Package/ Large pack
3683	Hard PVC	500	102015	90 - black	6 ROL / 40 BOX
	Hard PVC	500	102007	10 - white	6 ROL / 40 BOX
	Hard PVC	500	102013	47 - brown	6 ROL / 40 BOX
	Hard PVC	500	102011	33 - brick-red	6 ROL / 40 BOX

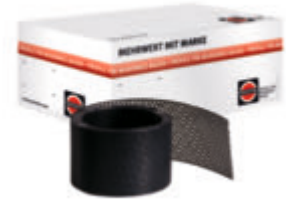

VENTILATION PROFILES

VENTILATION ANGLES WITH OVAL PERFORATION

Ventilation angle double-sided oval perforation Alu

Ventilation angle of 30 x 30 mm with double-sided oval perforation.

Ventilation area: 137/137 cm²/lfm.

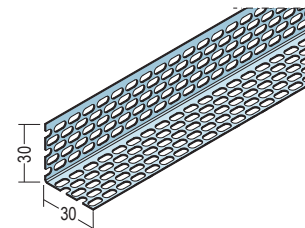

Item number	Material	Length (cm)	Order number	Color	Package/ Large pack
9603	Aluminum	250	115255	NA - natur	20 PCS / 224 BUN
9613	Aluminum	250	115259	90 - black	20 PCS / 224 BUN

Ventilation angle double-sided oval perforation Alu

Ventilation angle of 30 x 40 mm with double-sided oval perforation.

Ventilation area: 137/191 cm²/lfm.

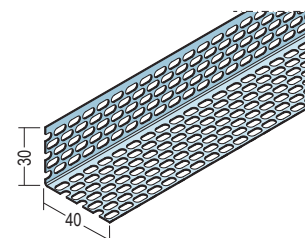

Item number	Material	Length (cm)	Order number	Color	Package/ Large pack
9604	Aluminum	250	115260	NA - natur	20 PCS / 168 BUN

Ventilation angle double-sided oval perforation Alu

Ventilation angle of 30 x 50 mm with double-sided oval perforation.

Ventilation area: 137/246 cm²/lfm.

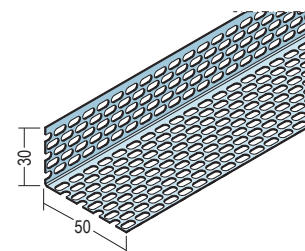

Item number	Material	Length (cm)	Order number	Color	Package/ Large pack
9605	Aluminum	250	115261	NA - natur	20 PCS / 144 BUN
9615	Aluminum	250	115264	90 - black	20 PCS / 144 BUN

Ventilation angle double-sided oval perforation Alu

Ventilation angle of 30 x 60 mm with double-sided oval perforation.

Ventilation area: 137/300 cm²/lfm.

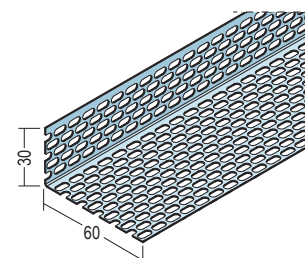

Item number	Material	Length (cm)	Order number	Color	Package/ Large pack
9606	Aluminum	250	115265	NA - natur	20 PCS / 120 BUN

Ventilation angle double-sided oval perforation Alu

Ventilation angle of 30 x 70 mm with double-sided oval perforation.

Ventilation area: 137/355 cm²/lfm.

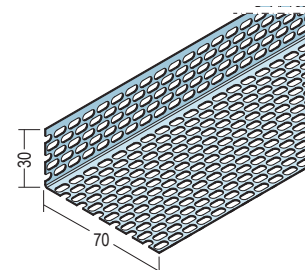

Item number	Material	Length (cm)	Order number	Color	Package/ Large pack
9607	Aluminum	250	115267	NA - natur	20 PCS / 117 BUN
9617	Aluminum	250	115268	90 - black	20 PCS / 103 BUN

VENTILATION PROFILES

VENTILATION ANGLES WITH OVAL PERFORATION

Ventilation angle double-sided oval perforation Alu

Ventilation angle of 30 x 80 mm with double-sided oval perforation.

Ventilation area: 137/409 cm²/lfm.

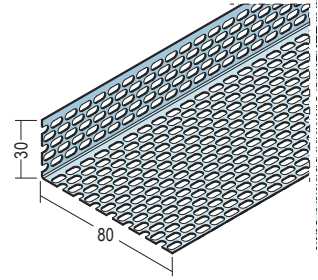

Item number	Material	Length (cm)	Order number	Color	Package/ Large pack
9608	Aluminum	250	115269	NA - natur	20 PCS / 104 BUN

Ventilation angle double-sided oval perforation Alu

Ventilation angle of 30 x 90 mm with double-sided oval perforation.

Ventilation area: 137/464 cm²/lfm.

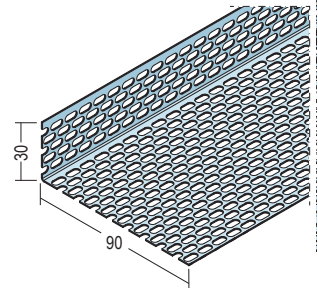

Item number	Material	Length (cm)	Order number	Color	Package/ Large pack
9609	Aluminum	250	115271	NA - natur	20 PCS / 84 BUN
9619	Aluminum	250	115272	90 - black	20 PCS / 84 BUN

Ventilation angle double-sided oval perforation Alu

Ventilation angle of 30 x 100 mm with double-sided oval perforation.

Ventilation area: 137/518 cm²/lfm.

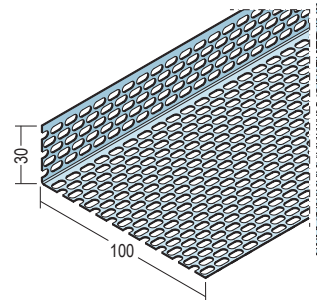

Item number	Material	Length (cm)	Order number	Color	Package/ Large pack
9610	Aluminum	250	115273	NA - natur	20 PCS / 83 BUN

Ventilation angle double-sided oval perforation Alu

Ventilation angle of 30 x 120 mm with double-sided oval perforation.

Ventilation area: 137/627 cm²/lfm.

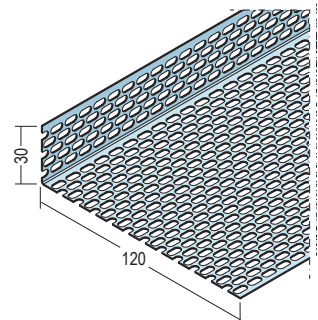

Item number	Material	Length (cm)	Order number	Color	Package/ Large pack
9612	Aluminum	250	115274	NA - natur	20 PCS / 69 BUN

Ventilation angle one-sided oval perforation Alu

Ventilation angle 10 x 50 mm with double-sided oval perforation.

Ventilation area: 220 cm²/lfm.

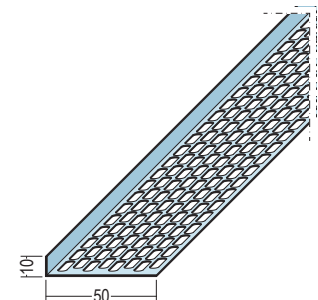

Item number	Material	Length (cm)	Order number	Color	Package/ Large pack
9695	Aluminum	250	113774	NA - natur	20 PCS / 200 BUN

VENTILATION PROFILES

VENTILATION ANGLES WITH OVAL PERFORATION

Ventilation angle one-sided oval perforation Alu

Ventilation angle 10 x 70 mm
with double-sided oval perforation.

Ventilation area: 310 cm²/lfm.

Item number	Material	Length (cm)	Order number	Color	Package/ Large pack
9697	Aluminum	250	113775	NA - natur	20 PCS / 200 BUN

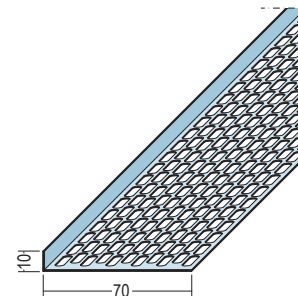

Ventilation angle one-sided oval perforation Alu

Ventilation angle 10 x 90mm
with double-sided oval perforation.

Ventilation area: 410 cm²/lfm.

Item number	Material	Length (cm)	Order number	Color	Package/ Large pack
9699	Aluminum	250	113776	NA - natur	20 PCS / 200 BUN

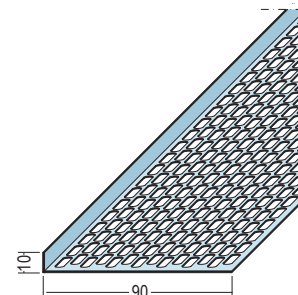

Ventilation angle one-sided oval perforation PVC

Ventilation angle of 30 x 30 mm
with single-sided oval perforation.

Ventilation area: 94 cm²/lfm.

Item number	Material	Length (cm)	Order number	Color	Package/ Large pack
3830	Hard PVC	250	108460	90 - black	20 PCS / 140 BUN
	Hard PVC	250	108458	33 - brick-red	20 PCS / 140 BUN
	Hard PVC	250	108457	10 - white	20 PCS / 140 BUN
	Hard PVC	250	108459	47 - brown	20 PCS / 140 BUN

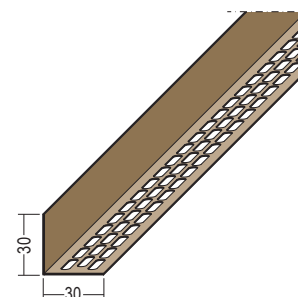

Ventilation angle one-sided oval perforation PVC

Ventilation angle of 30 x 50 mm
with single-sided oval perforation.

Ventilation area: 188 cm²/lfm.

Item number	Material	Length (cm)	Order number	Color	Package/ Large pack
3832	Hard PVC	250	108464	90 - black	20 PCS / 80 BUN
	Hard PVC	250	108462	33 - brick-red	20 PCS / 80 BUN
	Hard PVC	250	108463	47 - brown	20 PCS / 80 BUN
	Hard PVC	250	108461	10 - white	20 PCS / 80 BUN

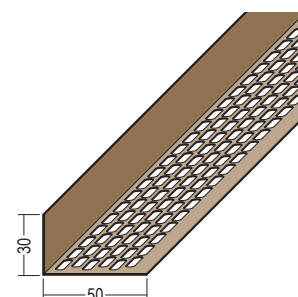

Ventilation angle one-sided oval perforation PVC

Ventilation angle of 30 x 60 mm
with single-sided oval perforation.

Ventilation area: 252 cm²/lfm.

Item number	Material	Length (cm)	Order number	Color	Package/ Large pack
3833	Hard PVC	250	108468	90 - black	20 PCS / 90 BUN
	Hard PVC	250	108465	10 - white	20 PCS / 90 BUN
	Hard PVC	250	108466	33 - brick-red	20 PCS / 90 BUN
	Hard PVC	250	108467	47 - brown	20 PCS / 90 BUN

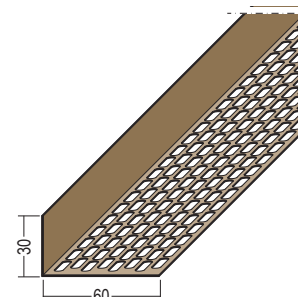

VENTILATION PROFILES

VENTILATION ANGLES WITH OVAL PERFORATION

Ventilation angle one-sided oval perforation PVC

Ventilation angle of 30 x 70 mm with single-sided oval perforation.

Ventilation area: 310 cm²/lfm.

Item number	Material	Length (cm)	Order number	Color	Package/ Large pack
3834	Hard PVC	250	108469	10 - white	20 PCS / 72 BUN
	Hard PVC	250	108472	90 - black	20 PCS / 72 BUN
	Hard PVC	250	108471	47 - brown	20 PCS / 72 BUN
	Hard PVC	250	108470	33 - brick-red	20 PCS / 72 BUN

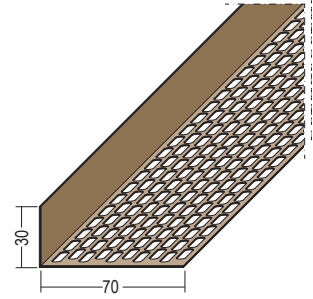

Ventilation angle one-sided oval perforation PVC

Ventilation angle of 30 x 90 mm with single-sided oval perforation.

Ventilation area: 410 cm²/lfm.

Item number	Material	Length (cm)	Order number	Color	Package/ Large pack
3836	Hard PVC	250	108474	33 - brick-red	20 PCS / 48 BUN
	Hard PVC	250	108473	10 - white	20 PCS / 48 BUN
	Hard PVC	250	108475	47 - brown	20 PCS / 48 BUN
	Hard PVC	250	108476	90 - black	20 PCS / 48 BUN

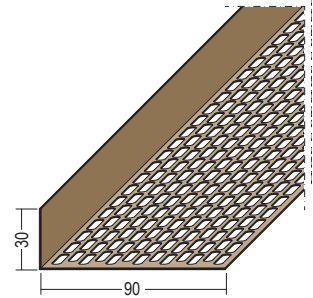

VENTILATION PROFILES

VENTILATION STRIP OVAL PERFORATION ALU

Ventilation strip oval perforation Alu

60-mm ventilation strips with oval perforations.

Ventilation area: 284 cm²/lfm.

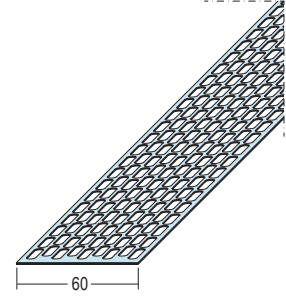

Item number	Material	Length (cm)	Order number	Color	Package/ Large pack
SALE 9626	Aluminum	250	108927	NA - natur	20 PCS / 154 BUN

Ventilation strip oval perforation Alu

70-mm ventilation strips with oval perforations.

Ventilation area: 315 cm²/lfm.

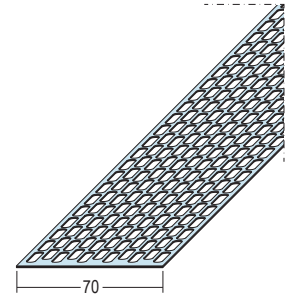

Item number	Material	Length (cm)	Order number	Color	Package/ Large pack
SALE 9627	Aluminum	250	108928	NA - natur	20 PCS / 135 BUN

Ventilation strip oval perforation Alu

80-mm ventilation strips with oval perforations.

Ventilation area: 378 cm²/lfm.

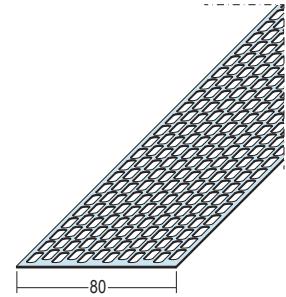

Item number	Material	Length (cm)	Order number	Color	Package/ Large pack
SALE 9628	Aluminum	250	108929	NA - natur	20 PCS / 120 BUN

Ventilation strip oval perforation Alu

90-mm ventilation strips with oval perforations.

Ventilation area: 410 cm²/lfm.

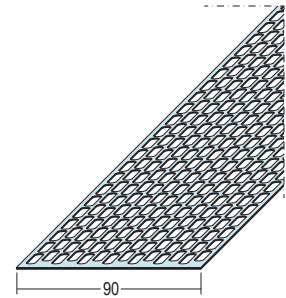

Item number	Material	Length (cm)	Order number	Color	Package/ Large pack
SALE 9629	Aluminum	250	108930	NA - natur	20 PCS / 106 BUN

Ventilation strip oval perforation Alu

100-mm ventilation strips with oval perforations.

Ventilation area: 473 cm²/lfm.

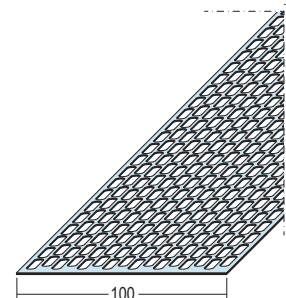

Item number	Material	Length (cm)	Order number	Color	Package/ Large pack
SALE 9630	Aluminum	250	108931	NA - natur	20 PCS / 80 BUN

VENTILATION PROFILES

VENTILATION STRIP OVAL PERFORATION ALU

Ventilation strip oval perforation Alu

120-mm ventilation strips with oval perforations.

Ventilation area: 567 cm²/lfm.

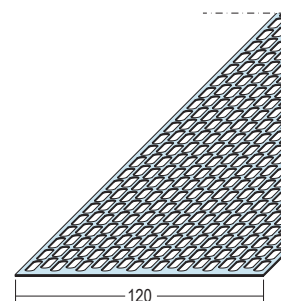

Item number	Material	Length (cm)	Order number	Color	Package/ Large pack
9632	Aluminum	250	108932	NA - natur	20 PCS / 75 BUN

SALE

Ventilation strip oval perforation rolled Alu

Rolled 50-mm ventilation strips with oval perforations in a convenient dispenser case.

Ventilation area: 221 cm²/lfm.



Item number	Material	Length (cm)	Order number	Color	Package/ Large pack
9640	Aluminum	6	109408	NA - natur	2 ROL / 46 BOX
9644	Aluminum	6	109420	97 - white/brown	2 ROL / 46 BOX
9648	Aluminum	6	109414	98 - black/red	2 ROL / 46 BOX

Ventilation strip oval perforation rolled Alu

Ventilation strips 80 mm rolled with oval perforations inside a convenient dispenser case.

Ventilation area: 378 cm²/lfm.



Item number	Material	Length (cm)	Order number	Color	Package/ Large pack
9641	Aluminum	6	109410	NA - natur	1 ROL / 46 BOX
9645	Aluminum	6	109422	97 - white/brown	1 ROL / 46 BOX
9649	Aluminum	6	109416	98 - black/red	1 ROL / 46 BOX

Ventilation strip oval perforation rolled Alu

Rolled 100-mm ventilation strips with oval perforations in a convenient dispenser case.

Ventilation area: 473 cm²/lfm.



Item number	Material	Length (cm)	Order number	Color	Package/ Large pack
9642	Aluminum	6	109412	NA - natur	1 ROL / 46 BOX
9646	Aluminum	6	109424	97 - white/brown	1 ROL / 46 BOX
9650	Aluminum	6	109418	98 - black/red	1 ROL / 46 BOX

VENTILATION PROFILES

VENTILATION STRIP OVAL PERFORATION PVC

Ventilation strip oval perforation rolled PVC

50-mm rolled ventilation strips with oval perforations.

Ventilation area: 220 cm²/lfm.

Item number	Material	Length (cm)	Order number	Color	Package/ Large pack
3841	Hard PVC	500	108478	33 - brick-red	32 ROL / 42 BOX
	Hard PVC	500	108477	10 - white	32 ROL / 42 BOX
	Hard PVC	500	108479	47 - brown	32 ROL / 42 BOX
	Hard PVC	500	108480	90 - black	32 ROL / 42 BOX
3846	Hard PVC	6	108492	90 - black	2 ROL / 46 BOX
	Hard PVC	6	108490	33 - brick-red	2 ROL / 46 BOX
	Hard PVC	6	108491	47 - brown	2 ROL / 46 BOX
	Hard PVC	6	108489	10 - white	2 ROL / 46 BOX



SALE

Ventilation strip oval perforation rolled PVC

80-mm rolled ventilation strips with oval perforations.

Ventilation area: 378 cm²/lfm.

Item number	Material	Length (cm)	Order number	Color	Package/ Large pack
3842	Hard PVC	500	108482	33 - brick-red	16 ROL / 42 BOX
	Hard PVC	500	108483	47 - brown	16 ROL / 42 BOX
	Hard PVC	500	108481	10 - white	16 ROL / 42 BOX
	Hard PVC	500	108484	90 - black	16 ROL / 42 BOX
3847	Hard PVC	6	108494	33 - brick-red	1 ROL / 46 BOX
	Hard PVC	6	108496	90 - black	1 ROL / 46 BOX
	Hard PVC	6	108493	10 - white	1 ROL / 46 BOX
	Hard PVC	6	108495	47 - brown	1 ROL / 46 BOX



Ventilation strip oval perforation rolled PVC

100-mm rolled ventilation strips with oval perforations.

Ventilation area: 472 cm²/lfm.

Item number	Material	Length (cm)	Order number	Color	Package/ Large pack
3843	Hard PVC	500	108488	90 - black	16 ROL / 42 BOX
	Hard PVC	500	108485	10 - white	16 ROL / 42 BOX
	Hard PVC	500	108486	33 - brick-red	16 ROL / 42 BOX
	Hard PVC	500	108487	47 - brown	16 ROL / 42 BOX
3848	Hard PVC	6	108454	33 - brick-red	1 ROL / 46 BOX
	Hard PVC	6	108456	90 - black	1 ROL / 46 BOX
	Hard PVC	6	108455	47 - brown	1 ROL / 46 BOX
	Hard PVC	6	108453	10 - white	1 ROL / 46 BOX



Ventilation strip square perforation rolled PVC

150-mm rolled ventilation strips with square perforations.

Ventilation area: 648 cm²/lfm.

Item number	Material	Length (cm)	Order number	Color	Package/ Large pack
3844	Hard PVC	500	108624	90 - black	12 ROL / 24 BOX
	Hard PVC	500	108623	47 - brown	12 ROL / 24 BOX
	Hard PVC	500	108621	10 - white	12 ROL / 24 BOX
	Hard PVC	500	108622	33 - brick-red	12 ROL / 24 BOX



VENTILATION PROFILES

VENTILATION STRIP OVAL PERFORATION PVC

Ventilation strip square perforation rolled PVC

180-mm rolled ventilation strips
with square perforations.

Ventilation area: 792 cm²/lfm.

Item number	Material	Length (cm)	Order number	Color	Package/ Large pack
3845	Hard PVC	500	108628	90 - black	6 ROL / 40 BOX
	Hard PVC	500	108626	33 - brick-red	6 ROL / 40 BOX
	Hard PVC	500	108627	47 - brown	6 ROL / 40 BOX
	Hard PVC	500	108625	10 - white	6 ROL / 40 BOX

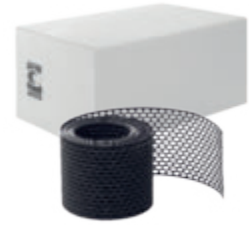



INSTRUCTIONS FOR APPLICATION

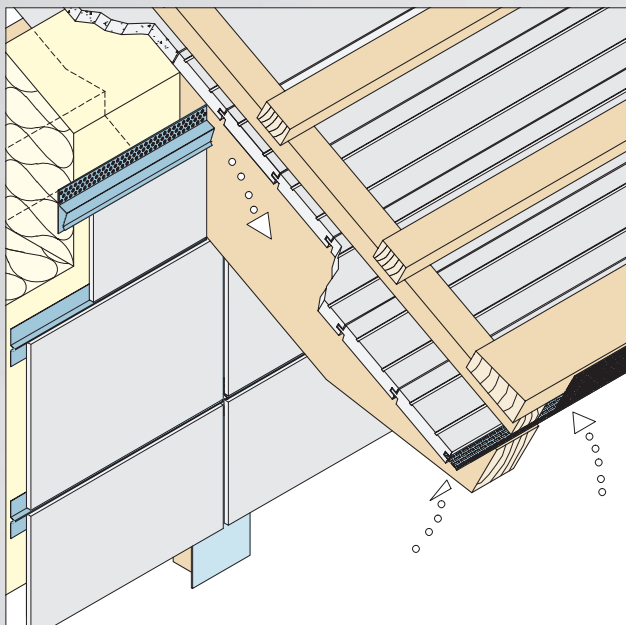

The ventilation profiles 9056 and 9059 are used in the upper facade area and under the window sills. The profiles can be used for board thicknesses of 4 to 6 mm and 8 to 15 mm.

The ventilation profiles 3662, 3663 and 3664 ensure a clean and flush facade stop with the horizontal and slanted roof side.

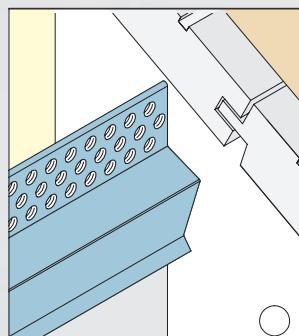
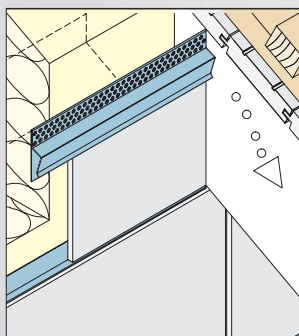

EAVES VENTILATION

Eaves ventilation Alu

Eaves ventilation profile for sheet thicknesses of 4 - 6 mm.

Ventilation area: 75 cm²/lfm.



Item number	Material	Length (cm)	Order number	Color	Package/ Large pack
9056	Aluminum	250	101586	NA - natur	10 PCS / 100 BUN

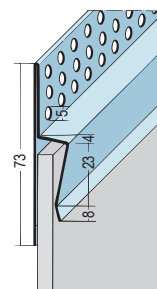

Eaves ventilation Alu

Eaves ventilation profile for sheet thicknesses of 8 - 15 mm.

Ventilation area: 75 cm²/lfm.



Item number	Material	Length (cm)	Order number	Color	Package/ Large pack
9059	Aluminum	250	101590	NA - natur	10 PCS / 100 BUN

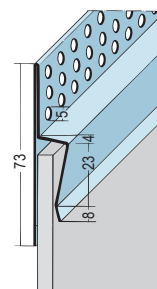

Eaves ventilation PVC

Eaves ventilation profile for sheet thicknesses of 9 mm.

Ventilation area: 100 cm²/lfm.

Item number	Material	Length (cm)	Order number	Color	Package/ Large pack
3662	Hard PVC	250	102315	90 - black	20 PCS / 35 BUN
	Hard PVC	250	102308	10 - white	20 PCS / 35 BUN

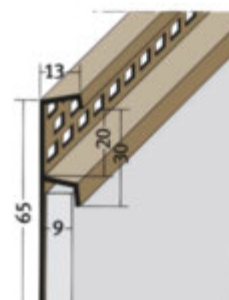

Eaves ventilation PVC

Eaves ventilation profile for sheet thicknesses of 17 mm.

Ventilation area: 100 cm²/lfm.

Item number	Material	Length (cm)	Order number	Color	Package/ Large pack
3663	Hard PVC	250	102328	10 - white	20 PCS / 23 BUN
	Hard PVC	250	102335	47 - brown	20 PCS / 23 BUN
	Hard PVC	250	102337	90 - black	20 PCS / 23 BUN

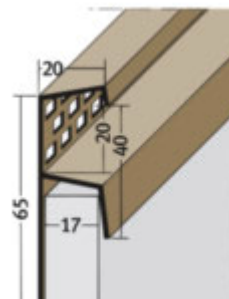

Eaves ventilation PVC

Eaves ventilation profile for sheet thicknesses of 27 mm.

Ventilation area: 104 cm²/lfm.

Item number	Material	Length (cm)	Order number	Color	Package/ Large pack
3618	Hard PVC	250	101141	10 - white	10 PCS / 88 BUN
	Hard PVC	250	101154	90 - black	10 PCS / 88 BUN

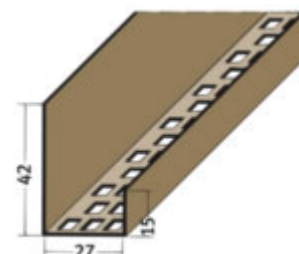

EAVES VENTILATION

Eaves profile

Eaves profile 85 x 30 mm, 135 °.
For the optimal removal of moisture that gets onto the underlay or underlay through the ingress of rain, drifting snow or condensate.

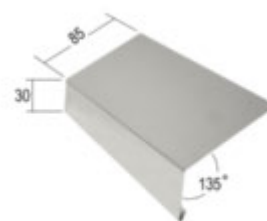

Item number	Material	Length (cm)	Order number	Color	Package/ Large pack
9385	Aluminum	250	116681	NA - natur	10 PCS / 140 BUN

Eaves ventilation Alu

Eaves ventilation profile for corrugated sheets, profile 5 and "Berliner Welle".

Ventilation area: 362 cm²/lfm.

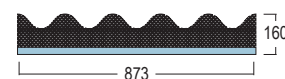

Item number	Material	Length (cm)	Order number	Color	Package/ Large pack
9063	Aluminum	87	105841	NA - natur	50 PC / 26 BOX

Eaves ventilation PVC

Eaves ventilation profile for corrugated sheets, profile 5 and "Berliner Welle".

Ventilation area: 695 cm²/lfm.

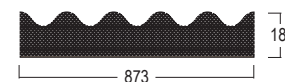

Item number	Material	Length (cm)	Order number	Color	Package/ Large pack
3687	Hard PVC	87	102424	90 - black	50 PC / 99 BOX
	Hard PVC	87	102420	47 - brown	50 PC / 36 BOX

Eaves ventilation PVC

Eaves ventilation profile for corrugated sheets, profile 6.

Ventilation area: 695 cm²/lfm.

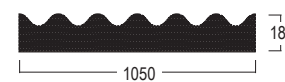

Item number	Material	Length (cm)	Order number	Color	Package/ Large pack
3688	Hard PVC	105	111783	47 - brown	50 PC / 28 BOX
	Hard PVC	105	111639	90 - black	50 PC / 28 BOX

SPECIAL PROFILES

We have tools for custom profiles for specialised purposes not listed in the catalogue. After a feasibility study, we need the following documents in order to generate a quotation:

- dimensioned drawing
- material specifications

Kindly contact us directly for a quote.

Please note the minimum production quantity of 200 metres per dimension.

The aforementioned special profiles can only be manufactured after an order has been submitted in writing and the necessary drawings and material specifications have been provided.

For powder coated parts, order the total quantity required to prevent differences in coating. There is no guarantee that the coating in repeat orders will appear exactly the same. Returns are therefore excluded.

Returns of fixed length orders, special profile and special accessory orders are excluded as well. For special parts, we reserve the right to deliver maximum or minimum quantities of $\pm 10\%$.

Custom designed profiles or special accessories are only manufactured according to customer requirements and under the exclusion of liability with regards to rights of third parties. We assume no liability for the stability and functionality of custom designs according to customer requirements.

EXAMPLES

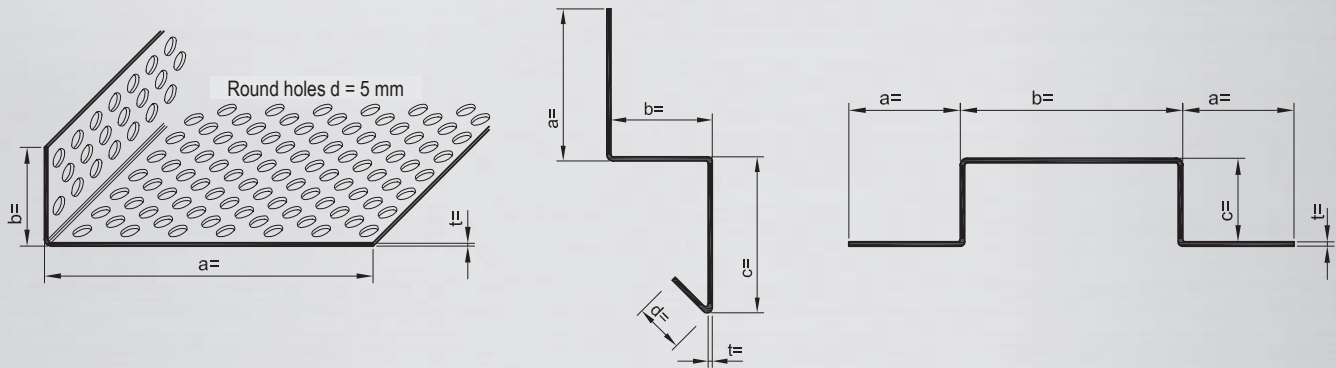

COLOUR COATING

All standard and special profiles made of aluminium can be polyester-powder coated if the RAL colour coding colour is indicated. Please contact us! Coating is possible from just 2 packaging units onwards.





ROOF DRAINAGE

Since 1964 we manufacture gutters made of plastic. Protektor gutters are without softener and can not embrittle. Due to the high-quality of the raw material the gutter ensures **impact resistance and a great UV and form stability.**

These quality characteristics are based on extensive tests. Environmental influences like acid rain, deposits of flue gases and salty air near the sea cannot damage the Protektor gutters. They are resistant against alkaline solutions and

acids. Beyond that the experience in the application and processing of high quality plastics such as co-extrusion (applying of a protective acryl layer on the base of the gutter) gives an improved surface quality and therefore, secures the high colour brilliance, and this also after many years.

As Protektor gutters are produced according to DIN, it is possible without any problems to mount the gutter into already existing gutter brackets.

DELIVERY, PACKAGING, FIRE PROPERTIES

Free delivery for net product values of 650.00 € and up

We ask for your understanding that, in cases of deviations in packaging units for gutters, downpipes, leaf guards, leaf trap grids, gutter brushes and roof strips, we charge a fee of 10.00 € per order for unpacking and repacking.

The disposal of packaging is regulated by Interseroh. Recycling certificate no. 25608

Fire properties: PROTEKTOR roof gutters are made of PVC-U. This plasticiser-free polyvinyl chloride (PVC-U), pursuant to DIN 19531, is classified as building material class B1 - not easily flammable - under DIN 4102, part 4

COLOURS

similar to RAL 9003 white (BA)	similar to RAL 7040 grey (BB)
similar to RAL 8024 brown (BD)	similar to RAL 8019 dark brown (BC)
similar to RAL 7016 anthracite grey (91)	

Our PROTEKTOR hard PVC profiles achieve the highest possible light durability level (level 8) on the wool scale. The formula we have developed together with our suppliers, prevents the usage of waste or reclaimed materials in our products. In accordance with our General Sales terms and conditions (section 6), we provide a guarantee of 5 years for the technical functionality.

HOW TO FIND THE CORRECT PIPE FOR YOUR ROOF DRAINAGE.

How to find the correct pipe for your roof drainage. The indicated m² values of the roof ground plan area are criterions to find the right gutter size.

According to DIN EN 12056-3 and DIN 1986-100 for each object a calculation of the rain water down pipe should be done. This is necessary to determine the exact gutter size.

PROTEKTOR – Halfround gutter		
Roof area to be drained / Square area in m ²	Rainwater drainpipe	Halfround gutter
to ca. 50 m ²	DN 75	8-tlg. (NW 100)
to ca. 80 m ²	DN 85	7-tlg. (NW 125)
to ca. 150 m ²	DN 100	6-tlg. (NW 150)
to ca. 220 m ²	DN 125	5-tlg. (NW 180)

PROTEKTOR – Boxgutters		
Roof area to be drained / Square area in m ²	Rainwater drainpipe	Boxgutters
to ca. 15 m ²	DN 50	10-tlg. (NW 68)
to ca. 30 m ²	DN 75	8-tlg. (NW 83)
to ca. 80 m ²	DN 85	6-tlg. (NW 115)

HALFROUND GUTTERS

NOMINAL SIZE (NW) 100 / 8-PART

Semi-circular gutter

NW 100 half-round gutter made of UV-resistant and shockproof PVC.

Floor width: 120
Notes:
 Bottom width: 125 mm
 Bead height: 65 mm
 Seam height: 75 mm



Item number	Material	Length (cm)	Order number	Color	Packaging
84501	PVC-U	200	105627	BA - white	5 PCS
84500	PVC-U	400	105624	BA - white	5 PCS
82000	PVC-U	200	105628	BB - grey	5 PCS
81000	PVC-U	400	105617	BB - grey	5 PCS
83601	PVC-U	200	105629	BD - brown	5 PCS
83600	PVC-U	400	105625	BD - brown	5 PCS
86101	PVC-U	200	105630	BC - dark brown	5 PCS
86100	PVC-U	400	105618	BC - dark brown	5 PCS
88601	PVC-U	200	114020	91 - anthracite	5 PCS
88600	PVC-U	400	114019	91 - anthracite	5 PCS

Gutter connector to clamp

Clip-on gutter connecting piece made of UV-resistant and shockproof PVC providing expansion compensation for NW 100 half-round gutters.

Notes:
 Use with laying temperature scale!
Processing instructions: Only clip on, do not slide in!



Item number	Material	Length (cm)	Order number	Color	Packaging
84520	PVC-U	19	116356	BA - white	10 PC
81020	PVC-U	19	116357	BB - grey	10 PC
83620	PVC-U	19	116358	BD - brown	10 PC
86120	PVC-U	19	116359	BC - dark brown	10 PC
88603	PVC-U	19	116360	91 - anthracite	10 PC

Semi-circular gutter cover left to clamp

Clip-on gutter end piece made of UV-resistant and shockproof PVC for the left end of NW 100 half-round gutters.

Notes:
 Left-side ending.



Item number	Material	Length (cm)	Order number	Color	Packaging
84513	PVC-U	4	104549	BA - white	5 PC
82013	PVC-U	4	104686	BB - grey	5 PC
83713	PVC-U	4	104845	BD - brown	5 PC
86113	PVC-U	4	104515	BC - dark brown	5 PC
88605	PVC-U	4	118584	91 - anthracite	5 PC

Semi-circular gutter cover right for clamp

Clip-on gutter end piece made of UV-resistant and shockproof PVC for the right end of NW 100 half-round gutters.

Notes:
 Right-side ending.



Item number	Material	Length (cm)	Order number	Color	Packaging
84514	PVC-U	4	104557	BA - white	5 PC
82014	PVC-U	4	104688	BB - grey	5 PC
83714	PVC-U	4	104852	BD - brown	5 PC
86114	PVC-U	4	104516	BC - dark brown	5 PC
88604	PVC-U	4	118586	91 - anthracite	5 PC

HALFROUND GUTTERS

NOMINAL SIZE (NW) 100 / 8-PART

Clip support

Clip-on drain fitting
made of UV-resistant and shockproof PVC
for NW 100 half-round gutters
and DN 75 rainwater downpipes.

Item number	Material	Length (cm)	Order number	Color	Packaging
84517	PVC-U	19	118583	BA - white	5 PC
82017	PVC-U	19	104692	BB - grey	5 PC
83617	PVC-U	19	104878	BD - brown	5 PC
86117	PVC-U	19	118585	BC - dark brown	5 PC
88607	PVC-U	19	118582	91 - anthracite	5 PC



Semi-circular gutter angle 90° outside to clamp

Clip-on 90° outside gutter angle
made of UV-resistant and shockproof PVC
for NW 100 half-round gutters.

Notes:
Custom-made products are possible. 2 clip-on
connectors are required for assembly.

Item number	Material	Length (cm)	Order number	Color	Packaging
84511	PVC-U	19	104524	BA - white	20 PC
81011	PVC-U	19	119115	BB - grey	20 PC
86111	PVC-U	19	104513	BC - dark brown	20 PC



Semi-circular gutter angle 90° inside to clamp

Clip-on 90° inside gutter angle
made of UV-resistant and shockproof PVC
for NW 100 half-round gutters.

Notes:
Custom-made products are possible. 2 clip-on
connectors are required for assembly.

Item number	Material	Length (cm)	Order number	Color	Packaging
84512	PVC-U	18	104542	BA - white	20 PC
81012	PVC-U	18	104284	BB - grey	20 PC
83612	PVC-U	18	104866	BD - brown	20 PC
86112	PVC-U	18	104514	BC - dark brown	20 PC



Gutter bracket galvanized

Galvanised gutter bracket
for NW 100 half-round gutters.

Notes:
Cut: 26 x 4 mm
Total length: 400 mm
Length from spring: 210 mm
Processing instructions: Suitable gutter-
bracket bending pliers no. 81255.

Item number	Material	Length (cm)	Order number	Color	Packaging
82012	Galvanised steel	40	104685		20 PC



HALFROUND GUTTERS

NOMINAL SIZE (NW) 100 / 8-PART

Gutter bracket galvanized/plastic coated

Galvanised gutter bracket with plastic coating for NW 100 half-round gutters.

Notes:
 Cut: 26 x 4 mm
 Total length: 400 mm
 Length from spring: 210 mm
Processing instructions: Suitable gutter-bracket bending pliers no. 81255.

Item number	Material	Length (cm)	Order number	Color	Packaging
84502	Galvanised steel	40	104490	BA - white	20 PC
81002	Galvanised steel	40	104215	BB - grey	20 PC
83602	Galvanised steel	40	104856	BD - brown	20 PC
86102	Galvanised steel	40	104250	BC - dark brown	20 PC
88608	Galvanised steel	40	114027	91 - anthracite	20 PC



Semi-circular gutter bracket support plastic

Fascia board gutter bracket made of UV-resistant and shockproof PVC for NW 100 half-round gutters.

Item number	Material	Length (cm)	Order number	Color	Packaging
84503	PVC-U	14	104497	BA - white	20 PC
81008	PVC-U	14	104217	BB - grey	20 PC
83608	PVC-U	14	104860	BD - brown	20 PC
86108	PVC-U	14	104251	BC - dark brown	20 PC
88639	PVC-U	14	119573	91 - anthracite	20 PC



Semi-circular gutter bracket support plastic adjust. 9 - 30°

Fascia board gutter bracket made of UV-resistant and shockproof PVC for NW 100 half-round gutters.

Notes:
 Adjustable between 9 and 30°.

Item number	Material	Length (cm)	Order number	Color	Packaging
84439	PVC-U	14	104435	BA - white	20 PC
81039	PVC-U	14	104229	BB - grey	20 PC
83639	PVC-U	14	104814	BD - brown	20 PC
86139	PVC-U	14	104263	BC - dark brown	20 PC
88606	PVC-U	14	114025	91 - anthracite	20 PC



Leaf trap grid NW 100 + NW 125

Leaf trap grid made of UV and shock-resistant PE for NW 100 to NW 125 half-round gutters.

Notes:
 Do not use leaf guards made of plastic on purely metal roofs due to the heat that may develop through long-term sun exposure.

Item number	Material	Length (cm)	Order number	Color	Packaging
85518	PE	200	112357	90 - black	10 PCS
	PE	300	104274	90 - black	10 PCS

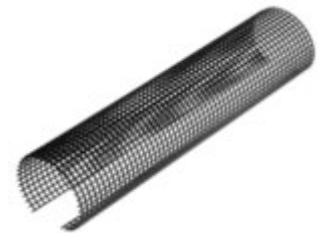

HALFROUND GUTTERS

NOMINAL SIZE (NW) 100 / 8-PART

Leaf trap grid NW 100 + NW 125

Leaf trap grid on the roll, made of UV and shock-resistant PE for NW 100 to NW 125 half-round gutters.

Notes:
Do not use leaf guards made of plastic on purely metal roofs due to the heat that may develop through long-term sun exposure.



Item number	Material	Length (cm)	Order number	Color	Packaging
85520	PE	300	117415	90 - black	1 ROL

Hedgehog gutter brush

Hedgehog gutter brush for NW 100 and NW 125 half-round gutters.

Notes:
Not suited for copper gutters.



Item number	Material	Length (cm)	Order number	Color	Packaging
85562		120	109648	90 - black	28 PC

Leaf trap stripe

Leaf guard for gutter sizes of NW 100 to NW 150.

Notes:
Do not use leaf guards made of plastic on purely metal roofs due to the heat that may develop through long-term sun exposure.



Item number	Material	Length (cm)	Order number	Color	Packaging
85558	PP	100	109464	90 - black	30 PCS
85559	PP	100	109465	BB - grey	30 PCS
85560	PP	100	109466	BD - brown	30 PCS

HALFROUND GUTTERS

NOMINAL SIZE (NW) 125 / 7-PART

Semi-circular gutter

NW 125 half-round gutter
made of UV-resistant and shockproof PVC.

Notes:
Bottom width: 142 mm
Bead height: 74 mm
Seam height: 84 mm
Floor width: 140



Item number	Material	Length (cm)	Order number	Color	Packaging
84201	PVC-U	200	105580	BA - white	5 PCS
84200	PVC-U	400	105579	BA - white	5 PCS
82200	PVC-U	200	105601	BB - grey	5 PCS
81200	PVC-U	400	105603	BB - grey	5 PCS
83001	PVC-U	200	105571	BD - brown	5 PCS
83000	PVC-U	400	105570	BD - brown	5 PCS
86201	PVC-U	200	105574	BC - dark brown	5 PCS
86200	PVC-U	400	105572	BC - dark brown	5 PCS

Gutter connector to clamp

Clip-on gutter connecting piece
made of UV-resistant and shockproof PVC
providing expansion compensation
for NW 125 half-round gutters.

Notes:
Use with laying temperature scale!
Processing instructions: Nur aufklipsen, nicht einschieben!



Item number	Material	Length (cm)	Order number	Color	Packaging
84220	PVC-U	25	116363	BA - white	10 PC
81220	PVC-U	25	116364	BB - grey	10 PC
83020	PVC-U	25	116365	BD - brown	10 PC
86220	PVC-U	25	116372	BC - dark brown	10 PC

Semi-circular gutter cover left to clamp

Clip-on gutter end piece
made of UV-resistant and shockproof PVC
for the left end of
NW 125 half-round gutters.

Notes:
Left-side ending.



Item number	Material	Length (cm)	Order number	Color	Packaging
84313	PVC-U	4	104349	BA - white	5 PC
82213	PVC-U	4	104607	BB - grey	5 PC
83213	PVC-U	4	104816	BD - brown	5 PC
86213	PVC-U	4	104530	BC - dark brown	5 PC

Semi-circular gutter cover right for clamp

Clip-on gutter end piece
made of UV-resistant and shockproof PVC
for the right end of
NW 125 half-round gutters.

Notes:
Right-side ending.



Item number	Material	Length (cm)	Order number	Color	Packaging
84314	PVC-U	4	104353	BA - white	5 PC
82214	PVC-U	4	104608	BB - grey	5 PC
83214	PVC-U	4	104819	BD - brown	5 PC
86214	PVC-U	4	104531	BC - dark brown	5 PC

HALFROUND GUTTERS

NOMINAL SIZE (NW) 125 / 7-PART

Clip support

Clip-on drain fitting
made of UV-resistant and shockproof PVC
for NW 125 half-round gutters and DN 75 rainwater
downpipes.



Item number	Material	Length (cm)	Order number	Color	Packaging
84017	PVC-U	23	104914	BA - white	5 PC
82417	PVC-U	23	104634	BB - grey	5 PC
83227	PVC-U	23	104840	BD - brown	5 PC
86617	PVC-U	23	104566	BC - dark brown	5 PC

Clip support

Clip-on drain fitting
made of UV-resistant and shockproof PVC
for NW 125 half-round gutters and DN 85 rainwater
downpipes.



Item number	Material	Length (cm)	Order number	Color	Packaging
82217	PVC-U	21	104618	BB - grey	5 PC
83017	PVC-U	21	104744	BD - brown	5 PC

Clip support

Clip-on drain fitting
made of UV-resistant and shockproof PVC
for NW 125 half-round gutters and DN 100 rain-
water downpipes.



Item number	Material	Length (cm)	Order number	Color	Packaging
84417	PVC-U	23	104382	BA - white	5 PC
82317	PVC-U	23	104629	BB - grey	5 PC
83817	PVC-U	23	104893	BD - brown	5 PC
86217	PVC-U	23	104532	BC - dark brown	5 PC

Semi-circular gutter angle 90° outside to clamp

Clip-on 90° outside gutter angle
made of UV-resistant and shockproof PVC
for NW 125 half-round gutters.

Notes:
Custom-made products are possible. 2 clip-on
connectors are required for assembly.



Item number	Material	Length (cm)	Order number	Color	Packaging
84211	PVC-U	22	104934	BA - white	16 PC
81211	PVC-U	22	118697	BB - grey	16 PC
83011	PVC-U	22	104729	BD - brown	16 PC
86211	PVC-U	22	104525	BC - dark brown	16 PC

Semi-circular gutter angle 90° inside to clamp

Clip-on 90° inside gutter angle
made of UV-resistant and shockproof PVC
for NW 125 half-round gutters.

Notes:
Custom-made products are possible. 2 clip-on
connectors are required for assembly.



Item number	Material	Length (cm)	Order number	Color	Packaging
84212	PVC-U	20	104935	BA - white	16 PC
81212	PVC-U	20	104482	BB - grey	16 PC
83012	PVC-U	20	104732	BD - brown	16 PC
86212	PVC-U	20	104527	BC - dark brown	16 PC

HALFROUND GUTTERS

NOMINAL SIZE (NW) 125 / 7-PART

Gutter bracket galvanized

Galvanised gutter bracket for NW 125 half-round gutters.

Notes:
 Cut: 30 x 4 mm
 Total length: 440 mm
 Length from spring: 210 mm
Processing instructions: Suitable gutter-bracket bending pliers no. 81255.



Item number	Material	Length (cm)	Order number	Color	Packaging
82212	Galvanised steel	44	104605		20 PC

Gutter bracket galvanized/plastic coated

Galvanised gutter bracket with plastic coating for NW 125 half-round gutters.

Notes:
 Cut: 30 x 4 mm
 Total length: 440 mm
 Length from spring: 210 mm
Processing instructions: Suitable gutter-bracket bending pliers no. 81255.



Item number	Material	Length (cm)	Order number	Color	Packaging
84202	Galvanised steel	44	104930	BA - white	20 PC
81202	Galvanised steel	44	104333	BB - grey	20 PC
83002	Galvanised steel	44	104723	BD - brown	20 PC
86202	Galvanised steel	44	104290	BC - dark brown	20 PC

Semi-circular gutter bracket support plastic

Fascia board gutter bracket made of UV-resistant and shockproof PVC for NW 125 half-round gutters.



Item number	Material	Length (cm)	Order number	Color	Packaging
84209	PVC-U	16	104933	BA - white	20 PC
81209	PVC-U	16	104472	BB - grey	20 PC
83009	PVC-U	16	104728	BD - brown	20 PC
86208	PVC-U	16	104297	BC - dark brown	20 PC

Semi-circular gutter bracket support plastic adjust. 9 - 30°

Fascia board gutter bracket made of UV-resistant and shockproof PVC for NW 125 half-round gutters.

Notes:
 Adjustable between 9 and 30°.



Item number	Material	Length (cm)	Order number	Color	Packaging
84239	PVC-U	16	106832	BA - white	20 PC
81239	PVC-U	16	106833	BB - grey	20 PC
83039	PVC-U	16	106834	BD - brown	20 PC
86239	PVC-U	16	106835	BC - dark brown	20 PC

HALFROUND GUTTERS

NOMINAL SIZE (NW) 125 / 7-PART

Leaf trap grid NW 100 + NW 125

Leaf trap grid made of UV and shock-resistant PE for NW 100 to NW 125 half-round gutters.

Notes:
Do not use leaf guards made of plastic on purely metal roofs due to the heat that may develop through long-term sun exposure.

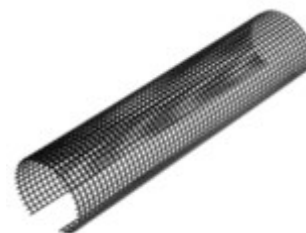

Item number	Material	Length (cm)	Order number	Color	Packaging
85518	PE	200	112357	90 - black	10 PCS
	PE	300	104274	90 - black	10 PCS

Leaf trap grid NW 100 + NW 125

Leaf trap grid on the roll, made of UV and shock-resistant PE for NW 100 to NW 125 half-round gutters.

Notes:
Do not use leaf guards made of plastic on purely metal roofs due to the heat that may develop through long-term sun exposure.



Item number	Material	Length (cm)	Order number	Color	Packaging
85520	PE	300	117415	90 - black	1 ROL

Leaf trap stripe

Leaf guard for gutter sizes of NW 100 to NW 150.

Notes:
Do not use leaf guards made of plastic on purely metal roofs due to the heat that may develop through long-term sun exposure.



Item number	Material	Length (cm)	Order number	Color	Packaging
85558	PP	100	109464	90 - black	30 PCS
85559	PP	100	109465	BB - grey	30 PCS
85560	PP	100	109466	BD - brown	30 PCS

Hedgehog gutter brush

Hedgehog gutter brush for NW 100 and NW 125 half-round gutters.

Notes:
Not suited for copper gutters.



Item number	Material	Length (cm)	Order number	Color	Packaging
85562		120	109648	90 - black	28 PC

HALFROUND GUTTERS

NOMINAL SIZE (NW) 150 / 6-PART

Semi-circular gutter

NW 150 half-round gutter
made of UV-resistant and shockproof PVC.

Notes:
Bottom width: 168 mm
Bead height: 88 mm
Seam height: 100 mm
Floor width: 160



Item number	Material	Length (cm)	Order number	Color	Packaging
84601	PVC-U	200	106115	BA - white	4 PCS
84600	PVC-U	400	106114	BA - white	4 PCS
82500	PVC-U	200	106110	BB - grey	4 PCS
81500	PVC-U	400	106111	BB - grey	4 PCS
83101	PVC-U	200	106117	BD - brown	4 PCS
83100	PVC-U	400	106116	BD - brown	4 PCS
86301	PVC-U	200	106119	BC - dark brown	4 PCS
86300	PVC-U	400	106118	BC - dark brown	4 PCS

Gutter connector to clamp

Clip-on gutter connecting piece
made of UV-resistant and shockproof PVC
providing expansion compensation
for NW 150 half-round gutters.

Notes:
Use with laying temperature scale!
Processing instructions: Only clip on, do not
slide in!



Item number	Material	Length (cm)	Order number	Color	Packaging
84620	PVC-U	25	116371	BA - white	10 PC
81520	PVC-U	25	119054	BB - grey	10 PC
83120	PVC-U	25	116370	BD - brown	10 PC
86320	PVC-U	25	116374	BC - dark brown	10 PC

Semi-circular gutter cover left to clamp

Clip-on gutter end piece
made of UV-resistant and shockproof PVC
for the left end of
NW 150 half-round gutters.

Notes:
Left-side ending.



Item number	Material	Length (cm)	Order number	Color	Packaging
84713	PVC-U	4	104667	BA - white	5 PC
82513	PVC-U	4	118588	BB - grey	5 PC
83313	PVC-U	4	104844	BD - brown	5 PC
86313	PVC-U	4	119313	BC - dark brown	5 PC

Semi-circular gutter cover right for clamp

Clip-on gutter end piece
made of UV-resistant and shockproof PVC
for the right end of
NW 150 half-round gutters.

Notes:
Right-side ending.



Item number	Material	Length (cm)	Order number	Color	Packaging
84714	PVC-U	4	119316	BA - white	5 PC
82514	PVC-U	4	118587	BB - grey	5 PC
83314	PVC-U	4	104847	BD - brown	5 PC
86314	PVC-U	4	104543	BC - dark brown	5 PC

HALFROUND GUTTERS

NOMINAL SIZE (NW) 150 / 6-PART

Clip support

Clip-on drain fitting
made of UV-resistant and shockproof PVC
for NW 150 half-round gutters and DN 100 rain-
water downpipes.

Item number	Material	Length (cm)	Order number	Color	Packaging
84717	PVC-U	23	104676	BA - white	5 PC
82517	PVC-U	23	118920	BB - grey	5 PC
83117	PVC-U	23	104731	BD - brown	5 PC
86317	PVC-U	23	104545	BC - dark brown	5 PC



Semi-circular gutter angle 90° outside to clamp

Clip-on 90° outside gutter angle
made of UV-resistant and shockproof PVC
for NW 150 half-round gutters.

Notes:
Custom-made products are possible. 2 clip-on
connectors are required for assembly.

Item number	Material	Length (cm)	Order number	Color	Packaging
84611	PVC-U	24	104599	BA - white	10 PC
81511	PVC-U	24	104328	BB - grey	10 PC
83111	PVC-U	24	104802	BD - brown	10 PC
86311	PVC-U	24	104537	BC - dark brown	10 PC



Semi-circular gutter angle 90° inside to clamp

Clip-on 90° inside gutter angle
made of UV-resistant and shockproof PVC
for NW 150 half-round gutters.

Notes:
Custom-made products are possible. 2 clip-on
connectors are required for assembly.

Item number	Material	Length (cm)	Order number	Color	Packaging
84612	PVC-U	22	104602	BA - white	10 PC
81512	PVC-U	22	104330	BB - grey	10 PC
83112	PVC-U	22	104804	BD - brown	10 PC
86312	PVC-U	22	104539	BC - dark brown	10 PC



Gutter bracket galvanized

Galvanised gutter bracket
for NW 150 half-round gutters.

Notes:
Cut: 30 x 5 mm
Total length: 480 mm
Length from spring: 210 mm
Processing instructions: Suitable gutter-
bracket bending pliers no. 81255.

Item number	Material	Length (cm)	Order number	Color	Packaging
82512	Galvanised steel	48	104640		20 PC



HALFROUND GUTTERS

NOMINAL SIZE (NW) 150 / 6-PART

Gutter bracket galvanized/plastic coated

Galvanised gutter bracket with plastic coating for NW 150 half-round gutters.

Notes:
 Cut: 30 x 5 mm
 Total length: 480 mm
 Length from spring: 210 mm
Processing instructions: Suitable gutter-bracket bending pliers no. 81255.



Item number	Material	Length (cm)	Order number	Color	Packaging
84602	Galvanised steel	48	104583	BA - white	20 PC
81502	Galvanised steel	48	104321	BB - grey	20 PC
83102	Galvanised steel	48	104791	BD - brown	20 PC
86302	Galvanised steel	48	104308	BC - dark brown	20 PC

Leaf trap grid NW 150 + NW 180

Leaf trap grid for gutter sizes of NW 150 to NW 180.

Notes:
 Do not use leaf guards made of plastic on purely metal roofs due to the heat that may develop through long-term sun exposure.

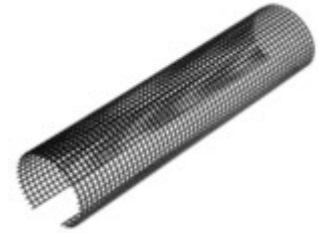

Item number	Material	Length (cm)	Order number	Color	Packaging
85519	PE	200	112356	90 - black	10 PCS
	PE	300	104275	90 - black	10 PCS

Leaf trap stripe

Leaf guard for gutter sizes of NW 100 to NW 150.

Notes:
 Do not use leaf guards made of plastic on purely metal roofs due to the heat that may develop through long-term sun exposure.



Item number	Material	Length (cm)	Order number	Color	Packaging
85558	PP	100	109464	90 - black	30 PCS
85559	PP	100	109465	BB - grey	30 PCS
85560	PP	100	109466	BD - brown	30 PCS

HALFROUND GUTTERS

NOMINAL SIZE (NW) 180 / 5-PART

Semi-circular gutter

NW 180 half-round gutter
made of UV-resistant and shockproof PVC.

Notes:
Bottom width: 202 mm
Bead height: 107 mm
Seam height: 120 mm
Floor width: 190



Item number	Material	Length (cm)	Order number	Color	Packaging
81800	PVC-U	400	106113	BB - grey	3 PCS

Gutter connector to clamp

Clip-on gutter connecting piece
made of UV-resistant and shockproof PVC
providing expansion compensation
for NW 180 half-round gutters.

Notes:
Use with laying temperature scale!
Processing instructions: Only clip on, do not
slide in!



Item number	Material	Length (cm)	Order number	Color	Packaging
81820	PVC-U	25	116369	BB - grey	14 PC

Semi-circular gutter cover left for sticking

Adhesive gutter end piece
made of UV-resistant and shockproof PVC
for the left end of
half-round NW 180 gutters.

Notes:
Left-side ending.
Processing instructions: Special adhesive no.
81250 should be used for this gutter end piece.



Item number	Material	Length (cm)	Order number	Color	Packaging
81813	PVC-U	2	104536	BB - grey	5 PC

Semi-circular gutter cover right for sticking

Adhesive gutter end piece
made of UV-resistant and shockproof PVC
for the right end of
half-round NW 180 gutters.

Notes:
Right-side ending.
Processing instructions: Special adhesive no.
81250 should be used for this gutter end piece.



Item number	Material	Length (cm)	Order number	Color	Packaging
81814	PVC-U	2	104538	BB - grey	5 PC

Clip support

Clip-on drain fitting
made of UV-resistant and shockproof PVC
for NW 180 half-round gutters and DN 125 rain-
water downpipes.



Item number	Material	Length (cm)	Order number	Color	Packaging
82817	PVC-U	24	116159	BB - grey	5 PC

HALFROUND GUTTERS

NOMINAL SIZE (NW) 180 / 5-PART

Semi-circular gutter angle 90° outside

Gutter angle 90° for outside corners made of UV-resistant and shockproof PVC for NW 180 half-round gutters.

Processing instructions: 2 clip-on connectors are required for assembly. Special adhesive no. 81250 should be used for this gutter angle.



Item number	Material	Length (cm)	Order number	Color	Packaging
81811	PVC-U	44	104529	BB - grey	8 PC

Semi-circular gutter angle 90° inside

Gutter angle 90° for inside corners made of UV-resistant and shockproof PVC for half-round NW 180 gutters.

Processing instructions: 2 clip-on connectors are required for assembly. Special adhesive no. 81250 should be used for this gutter angle.



Item number	Material	Length (cm)	Order number	Color	Packaging
81812	PVC-U	37	104534	BB - grey	8 PC

Gutter bracket galvanized

Galvanised gutter bracket for NW 100 half-round gutters.

Notes:
Cut 30 x 5 mm
Total length: 520 mm
Length from spring: 250 mm
Processing instructions: Suitable gutter-bracket bending pliers no. 81255.



Item number	Material	Length (cm)	Order number	Color	Packaging
82812	Galvanised steel	52	104709		20 PC

Gutter bracket galvanized/plastic coated

Galvanised gutter bracket with plastic coating for NW 180 half-round gutters.

Notes:
Cut: 30 x 5 mm
Total length: 550 mm
Length from spring: 250 mm
Processing instructions: Suitable gutter-bracket bending pliers no. 81255.



Item number	Material	Length (cm)	Order number	Color	Packaging
81802	Galvanised steel	55	104488	BB - grey	20 PC

Leaf trap grid NW 150 + NW 180

Leaf trap grid for gutter sizes of NW 150 to NW 180.

Notes:
Do not use leaf guards made of plastic on purely metal roofs due to the heat that may develop through long-term sun exposure.

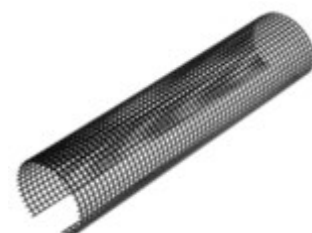

Item number	Material	Length (cm)	Order number	Color	Packaging
85519	PE	200	112356	90 - black	10 PCS
	PE	300	104275	90 - black	10 PCS

BOX GUTTERS

NOMINAL SIZE (NW) 68 / 10-PART

Box gutter

NW 68 box-shaped gutter made of UV-resistant and shockproof PVC.

Notes:
 Bottom width: 68 mm
 Bead height: 50 mm
 Seam height: 55 mm
Processing instructions: Special adhesive no. 81250 should be used for all box-shaped gutter components.
Floor width: 80



Item number	Material	Length (cm)	Order number	Color	Packaging
84101	PVC-U	200	105536	BA - white	8 PCS
84100	PVC-U	300	105383	BA - white	8 PCS
81101	PVC-U	200	105382	BB - grey	8 PCS
81100	PVC-U	300	105380	BB - grey	8 PCS
83501	PVC-U	200	105520	BD - brown	8 PCS
83500	PVC-U	300	105384	BD - brown	8 PCS
86501	PVC-U	200	105385	BC - dark brown	8 PCS
86500	PVC-U	300	105437	BC - dark brown	8 PCS

Box gutter cover left

Adhesive gutter end piece made of UV-resistant and shockproof PVC for the left end of NW 68 box-shaped gutters

Notes:
 Left-side ending.
Processing instructions: Special adhesive no. 81250 should be used for all box-shaped gutter components.



Item number	Material	Length (cm)	Order number	Color	Packaging
84113	PVC-U	1	104899	BA - white	10 PC
81113	PVC-U	1	104239	BB - grey	10 PC
83513	PVC-U	1	104805	BD - brown	10 PC
86513	PVC-U	1	104350	BC - dark brown	10 PC

Box gutter cover right

Adhesive gutter connecting piece made of UV-resistant and shockproof PVC for the right end of NW 68 box-shaped gutters.

Notes:
 Right-side ending.
Processing instructions: Special adhesive no. 81250 should be used for all box-shaped gutter components.



Item number	Material	Length (cm)	Order number	Color	Packaging
84114	PVC-U	1	104901	BA - white	10 PC
81114	PVC-U	1	104240	BB - grey	10 PC
83514	PVC-U	1	104812	BD - brown	10 PC
86514	PVC-U	1	104351	BC - dark brown	10 PC

Box gutter connector

Adhesive gutter connecting piece made of UV-resistant and shockproof PVC offering expansion compensation (dilatation) for NW 68 box-shaped gutters.

Processing instructions: Special adhesive no. 81250 should be used for all box-shaped gutter components.



Item number	Material	Length (cm)	Order number	Color	Packaging
84022	PVC-U	200	107349	BA - white	1 PC
81122	PVC-U	200	107350	BB - grey	1 PC
83522	PVC-U	200	107351	BD - brown	1 PC
86522	PVC-U	200	107352	BC - dark brown	1 PC

BOX GUTTERS

NOMINAL SIZE (NW) 68 / 10-PART

Box gutter connector

Adhesive gutter connecting piece made of UV-resistant and shockproof PVC for NW 68 box-shaped gutters.

Processing instructions: Special adhesive no. 81250 should be used for all box-shaped gutter components.



Item number	Material	Length (cm)	Order number	Color	Packaging
84119	PVC-U	5	104908	BA - white	10 PC
81119	PVC-U	5	104245	BB - grey	10 PC
83519	PVC-U	5	104826	BD - brown	10 PC
86519	PVC-U	5	104358	BC - dark brown	10 PC

Box gutter screw connector

Adhesive screw socket made of UV-resistant and shockproof PVC for NW 68 box-shaped gutters and DN 50 down-pipes.

Notes:
Auch für kastenförmige Metallrinnen.
Auch für Übergänge auf HT-Rohre.
Processing instructions: Also suitable for box-shaped metal gutters.



Item number	Material	Length (cm)	Order number	Color	Packaging
84132	PVC-U	6	107567	BA - white	10 PC
81132	PVC-U	6	107566	BB - grey	10 PC
83532	PVC-U	6	107568	BD - brown	10 PC
86532	PVC-U	6	107569	BC - dark brown	10 PC
88568	PVC-U	6	110928	91 - anthracite	10 PC

Box gutter drain

Adhesive clip supports made of UV-resistant and shockproof PVC for NW 68 box-shaped gutters and DN 50 down-pipes.

Processing instructions: Special adhesive no. 81250 should be used for all box-shaped gutter components.



Item number	Material	Length (cm)	Order number	Color	Packaging
84117	PVC-U	7	104905	BA - white	5 PC
81117	PVC-U	7	104243	BB - grey	5 PC
83517	PVC-U	7	104821	BD - brown	5 PC
86517	PVC-U	7	104355	BC - dark brown	5 PC

Box gutter angle 90° outside

Adhesive outside gutter angle made of UV-resistant and shockproof PVC for NW 68 box-shaped gutters.

Processing instructions: 2 adhesive connectors are required for assembly. Special adhesive no. 81250 should be used for all box-shaped gutter components.



Item number	Material	Length (cm)	Order number	Color	Packaging
84111	PVC-U	11	104897	BA - white	20 PC
81111	PVC-U	11	104237	BB - grey	20 PC
83511	PVC-U	11	104799	BD - brown	20 PC
86511	PVC-U	11	104346	BC - dark brown	20 PC

BOX GUTTERS

NOMINAL SIZE (NW) 68 / 10-PART

Box gutter angle 90° inside

Adhesive inside 90° gutter angle made of UV-resistant and shockproof PVC for NW 68 box-shaped gutters.

Processing instructions: 2 adhesive connectors are required for assembly. Special adhesive no. 81250 should be used for all box-shaped gutter components.



Item number	Material	Length (cm)	Order number	Color	Packaging
84112	PVC-U	11	104898	BA - white	20 PC
81112	PVC-U	11	104238	BB - grey	20 PC
83512	PVC-U	11	104801	BD - brown	20 PC
86512	PVC-U	11	104348	BC - dark brown	20 PC

Box gutter angle 135° outside

Adhesive 135° outside gutter angle made of UV-resistant and shockproof PVC for NW 68 box-shaped gutters.

Processing instructions: Special adhesive no. 81250 should be used for all box-shaped gutter components.



Item number	Material	Length (cm)	Order number	Color	Packaging
84141	PVC-U	11	104924	BA - white	20 PC
81141	PVC-U	11	104322	BB - grey	20 PC
83541	PVC-U	11	104846	BD - brown	20 PC
86541	PVC-U	11	104368	BC - dark brown	20 PC

Box gutter bracket galvanized/plastic coated

Galvanised and plastic-coated gutter bracket for NW 68 box-shaped gutters.

Notes:

Cut: 26 x 3 mm
Total length: 330 mm
Length from spring: 180 mm

Processing instructions: Suitable gutter-bracket bending pliers no. 81255.



Item number	Material	Length (cm)	Order number	Color	Packaging
84102	Galvanised steel	21	104891	BA - white	20 PC
81715	Galvanised steel	21	104463	BB - grey	20 PC
83502	Galvanised steel	21	104793	BD - brown	20 PC
86502	Galvanised steel	21	104342	BC - dark brown	20 PC

Box gutter bracket support plastic

Fascia board box-shaped gutter bracket made of UV-resistant and shockproof PVC for NW 68 box-shaped gutters.



Item number	Material	Length (cm)	Order number	Color	Packaging
81103	PVC-U	9	104233	BA - white	20 PC
81102	PVC-U	9	104232	BB - grey	20 PC
81104	PVC-U	9	104234	BD - brown	20 PC
86504	PVC-U	9	104344	BC - dark brown	20 PC

BOX GUTTERS

NOMINAL SIZE (NW) 68 / 10-PART

Box gutter bracket support plastic adjustable 9 - 30°

Fascia board box-shaped gutter bracket made of UV-resistant and shockproof PVC for NW 68 box-shaped gutters, adjustable from 9 to 30°.

Notes:
Adjustable between 9 and 30°.



Item number	Material	Length (cm)	Order number	Color	Packaging
84139	PVC-U	10	104923	BA - white	20 PC
81139	PVC-U	10	104269	BB - grey	20 PC
83539	PVC-U	10	104843	BD - brown	20 PC
86539	PVC-U	10	104366	BC - dark brown	20 PC

BOX GUTTERS

NOMINAL SIZE (NW) 83 / 8-PART

Box gutter

NW 83 box-shaped gutter made of UV-resistant and shockproof PVC.

Notes:
 Bottom width: 83 mm
 Bead height: 60 mm
 Seam height: 65 mm
Processing instructions: Special adhesive no. 81250 should be used for all box-shaped gutter components.
Floor width: 100



Item number	Material	Length (cm)	Order number	Color	Packaging
88001	PVC-U	200	105541	BB - grey	4 PCS
88000	PVC-U	300	105471	BB - grey	4 PCS
83401	PVC-U	200	105532	BD - brown	4 PCS
83400	PVC-U	300	105473	BD - brown	4 PCS

Box gutter cover left

Adhesive gutter end piece made of UV-resistant and shockproof PVC for the left end of NW 83 box-shaped gutters

Notes:
 Left-side ending.
Processing instructions: Special adhesive no. 81250 should be used for all box-shaped gutter components.



Item number	Material	Length (cm)	Order number	Color	Packaging
88013	PVC-U	2	104505	BB - grey	10 PC
83413	PVC-U	2	104869	BD - brown	10 PC

Box gutter cover right

Adhesive gutter connecting piece made of UV-resistant and shockproof PVC for the right end of NW 83 box-shaped gutters.

Notes:
 Right-side ending.
Processing instructions: Special adhesive no. 81250 should be used for all box-shaped gutter components.



Item number	Material	Length (cm)	Order number	Color	Packaging
88014	PVC-U	2	104506	BB - grey	10 PC
83414	PVC-U	2	104871	BD - brown	10 PC

Box gutter connector

Adhesive gutter connecting piece made of UV-resistant and shockproof PVC offering expansion compensation (dilatation) for NW 83 box-shaped gutters.

Processing instructions: Special adhesive no. 81250 should be used for all box-shaped gutter components.



Item number	Material	Length (cm)	Order number	Color	Packaging
88022	PVC-U	200	107353	BB - grey	1 PC
83422	PVC-U	200	107354	BD - brown	1 PC

BOX GUTTERS

NOMINAL SIZE (NW) 83 / 8-PART

Box gutter connector

Adhesive gutter connecting piece made of UV-resistant and shockproof PVC for NW 83 box-shaped gutters.

Processing instructions: Special adhesive no. 81250 should be used for all box-shaped gutter components.



Item number	Material	Length (cm)	Order number	Color	Packaging
88019	PVC-U	5	104507	BB - grey	10 PC
83419	PVC-U	5	104879	BD - brown	10 PC

Box gutter screw connector

Adhesive screw socket made of UV-resistant and shockproof PVC for NW 83 box-shaped gutters and DN 75 down-pipes.

Notes:
Auch für kastenförmige Metallrinnen.
Auch für Übergänge auf HT-Rohre.
Processing instructions: Also suitable for box-shaped metal gutters.



Item number	Material	Length (cm)	Order number	Color	Packaging
84432	PVC-U	6	106616	BA - white	10 PC
82032	PVC-U	6	106717	BB - grey	10 PC
83632	PVC-U	6	106715	BD - brown	10 PC
86232	PVC-U	6	106716	BC - dark brown	10 PC
88564	PVC-U	6	110923	91 - anthracite	10 PC

Box gutter angle 90° outside

Adhesive 90° outside gutter angle made of UV-resistant and shockproof PVC for NW 83 box-shaped gutters.

Processing instructions: 2 adhesive connectors are required for assembly. Special adhesive no. 81250 should be used for all box-shaped gutter components.

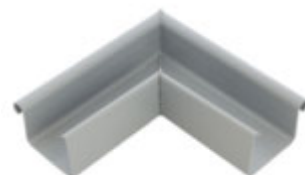

Item number	Material	Length (cm)	Order number	Color	Packaging
88011	PVC-U	29	104747	BB - grey	20 PC
83411	PVC-U	29	104862	BD - brown	20 PC

Box gutter angle 90° inside

Adhesive 90° inside gutter angle made of UV-resistant and shockproof PVC for NW 83-shaped box-shaped gutters.

Processing instructions: 2 adhesive connectors are required for assembly. Special adhesive no. 81250 should be used for all box-shaped gutter components.



Item number	Material	Length (cm)	Order number	Color	Packaging
88012	PVC-U	25	104749	BB - grey	20 PC
83412	PVC-U	25	104865	BD - brown	20 PC

BOX GUTTERS

NOMINAL SIZE (NW) 83 / 8-PART

Box gutter bracket galvanized/plastic coated

Galvanised and plastic-coated gutter bracket for NW 83 box-shaped gutters.

Notes:

Cut: 26 x 4 mm

Total length: 360 mm

Length from spring: 200 mm

Processing instructions: Suitable gutter-bracket bending pliers no. 81255.



Item number	Material	Length (cm)	Order number	Color	Packaging
88002	Galvanised steel	26	104504	BB - grey	20 PC
83402	Galvanised steel	26	104859	BD - brown	20 PC

Box gutter bracket support plastic

Fascia board box-shaped gutter bracket made of UV-resistant and shockproof PVC for NW 83 box-shaped gutters.



Item number	Material	Length (cm)	Order number	Color	Packaging
88008	PVC-U	11	107976	BB - grey	20 PC
	PVC-U	11	107978	BD - brown	20 PC

Box gutter bracket support plastic adjustable 9 - 30°

Fascia board box-shaped gutter bracket made of UV-resistant and shockproof PVC for NW 83 box-shaped gutters, adjustable from 9 to 30°.

Notes:

Adjustable between 9 and 30°.



Item number	Material	Length (cm)	Order number	Color	Packaging
88039	PVC-U	10	116914	BB - grey	10 PC
83439	PVC-U	10	116915	BD - brown	10 PC

BOX GUTTERS

NOMINAL SIZE (NW) 115 / 6-PART

Box gutter

NW 115 box-shaped gutter made of UV-resistant and shockproof PVC.

Notes:
 Bottom width: 117 mm
 Bead height: 70 mm
 Seam height: 85 mm
Processing instructions: Special adhesive no. 81250 should be used for all box-shaped gutter components.
Floor width: 160



Item number	Material	Length (cm)	Order number	Color	Packaging
86001	PVC-U	200	105539	BB - grey	4 PCS
86000	PVC-U	300	105538	BB - grey	4 PCS

Box gutter cover left

Adhesive gutter end piece made of UV-resistant and shockproof PVC for the left end of NW 115 box-shaped gutters

Notes:
 Left-side ending.
Processing instructions: Special adhesive no. 81250 should be used for all box-shaped gutter components.



Item number	Material	Length (cm)	Order number	Color	Packaging
86013	PVC-U	2	104286	BB - grey	10 PC

Box gutter cover right

Adhesive gutter connecting piece made of UV-resistant and shockproof PVC for the right end of NW 115 box-shaped gutters.

Notes:
 Right-side ending.
Processing instructions: Special adhesive no. 81250 should be used for all box-shaped gutter components.



Item number	Material	Length (cm)	Order number	Color	Packaging
86014	PVC-U	2	104288	BB - grey	10 PC

Box gutter connector

Adhesive gutter connecting piece made of UV-resistant and shockproof PVC offering expansion compensation (dilatation) for NW 115 box-shaped gutters.

Processing instructions: Special adhesive no. 81250 should be used for all box-shaped gutter components.



Item number	Material	Length (cm)	Order number	Color	Packaging
86022	PVC-U	200	107356	BB - grey	1 PC

Box gutter connector

Adhesive gutter connecting piece made of UV-resistant and shockproof PVC for NW 115 box-shaped gutters.

Processing instructions: Special adhesive no. 81250 should be used for all box-shaped gutter components.



Item number	Material	Length (cm)	Order number	Color	Packaging
86019	PVC-U	6	104247	BB - grey	10 PC

BOX GUTTERS

NOMINAL SIZE (NW) 115 / 6-PART

Box gutter screw connector

Adhesive screw socket made of UV-resistant and shockproof PVC for NW 115 box-shaped gutters and DN 100 down-pipes.

Notes:
Auch für kastenförmige Metallrinnen.
Auch für Übergänge auf HT-Rohre.
Processing instructions: Also suitable for box-shaped metal gutters.



Item number	Material	Length (cm)	Order number	Color	Packaging
81532	PVC-U	6	107358	BB - grey	10 PC

Box gutter drain

Adhesive clip supports made of UV-resistant and shockproof PVC for NW 115 box-shaped gutters and DN 85 down-pipes.

Processing instructions: Special adhesive no. 81250 should be used for all box-shaped gutter components.



Item number	Material	Length (cm)	Order number	Color	Packaging
86017	PVC-U	11	104294	BB - grey	5 PC

Box gutter angle 90° outside

Adhesive 90° outside gutter angle made of UV-resistant and shockproof PVC for NW 83 box-shaped gutters.

Processing instructions: 2 adhesive connectors are required for assembly. Special adhesive no. 81250 should be used for all box-shaped gutter components.

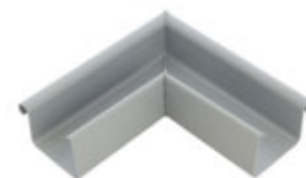

Item number	Material	Length (cm)	Order number	Color	Packaging
86011	PVC-U	31	104282	BB - grey	10 PC

Box gutter angle 90° inside

Adhesive 90° inside gutter angle made of UV-resistant and shockproof PVC for NW 115-shaped box-shaped gutters.

Processing instructions: 2 adhesive connectors are required for assembly. Special adhesive no. 81250 should be used for all box-shaped gutter components.



Item number	Material	Length (cm)	Order number	Color	Packaging
86012	PVC-U	35	104285	BB - grey	10 PC

Box gutter bracket galvanized/plastic coated

Galvanised and plastic-coated gutter bracket for NW 115 box-shaped gutters.

Notes:
Cut: 30 x 4 mm
Total length: 480 mm
Length from spring: 200 mm
Processing instructions: Suitable gutter-bracket bending pliers no. 81255.



Item number	Material	Length (cm)	Order number	Color	Packaging
86002	Galvanised steel	30	104279	BB - grey	20 PC

GUTTER ACCESSORIES

Adhesive for PVC tube

Special dissolving adhesive for the quick and reliable bonding of molded parts made of rigid PVC with good temperature resistance and good UV resistance.

Notes:

Tube 180g

Processing instructions: Transparent and fast-setting.

For bonding gaps < 0.1 mm.



Item number	Material	Length (cm)	Order number	Color	Packaging
81250		19	116916		30 PC

Gutter bracket bending pliers

Bending pliers for gutter brackets



Item number	Material	Length (cm)	Order number	Color	Packaging
81255	Galvanised steel	200	104949	J3 - fir green	1 PC

Gutter repair tape

Repair tape for gluing to half-round and box-shaped gutters.



Item number	Material	Length (cm)	Order number	Color	Packaging
82222	PVC-U	250	106951	90 - black	1 PCS

GUTTER PIPES AND ACCESSORIES

NOMINAL DIAMETER (DN) 50

Rainwater downpipe

Rainwater downpipe including plug socket made of UV and shock-resistant PVC for DN 50 roof gutters.



Item number	Material	Length (cm)	Order number	Color	Packaging
84015	PVC-U	100	104913	BA - white	10 PCS
84115	PVC-U	200	104902	BA - white	10 PCS
84915	PVC-U	250	104724	BA - white	10 PCS
82115	PVC-U	100	104700	BB - grey	10 PCS
81115	PVC-U	200	104241	BB - grey	10 PCS
83415	PVC-U	100	104872	BD - brown	10 PCS
83515	PVC-U	200	104817	BD - brown	10 PCS
86215	PVC-U	100	104299	BC - dark brown	10 PCS
86515	PVC-U	200	104352	BC - dark brown	10 PCS
	PVC-U	250	105099	BC - dark brown	10 PCS
88565	PVC-U	200	110925	91 - anthracite	10 PCS
88566	PVC-U	250	110926	91 - anthracite	10 PCS

Rainwater downpipe bend 45°

45° pipe elbow made of UV and shock-resistant PVC for DN 50 rainwater downpipes.



Item number	Material	Length (cm)	Order number	Color	Packaging
84116	PVC-U	12	104904	BA - white	10 PC
81900	PVC-U	12	104674	BB - grey	10 PC
83516	PVC-U	12	104818	BD - brown	10 PC
86516	PVC-U	12	104354	BC - dark brown	10 PC
88567	PVC-U	12	110927	91 - anthracite	10 PC

Rainwater downpipe bend 87°

87° pipe elbow made of UV and shock-resistant PVC for DN 50 rainwater downpipes.



Item number	Material	Length (cm)	Order number	Color	Packaging
84110	PVC-U	12	104895	BA - white	10 PC
81901	PVC-U	12	104675	BB - grey	10 PC
83416	PVC-U	12	104875	BD - brown	10 PC
86816	PVC-U	12	104386	BC - dark brown	10 PC
88572	PVC-U	14	110932	91 - anthracite	10 PC

Pipe socket to stuck

Pipe plug socket made of UV and shock-resistant PVC for DN 50 rainwater downpipes.



Item number	Material	Length (cm)	Order number	Color	Packaging
84134	PVC-U	8	104922	BA - white	945 PC
81134	PVC-U	8	104268	BB - grey	945 PC
83534	PVC-U	8	104839	BD - brown	945 PC
86534	PVC-U	8	104363	BC - dark brown	945 PC
88569	PVC-U	8	110929	91 - anthracite	945 PC

GUTTER PIPES AND ACCESSORIES

NOMINAL DIAMETER (DN) 50

Arch piece

Moveable arch piece made of UV-resistant and shockproof PVC for DN 50 rainwater downpipes.

Notes:
Customised angle settings possible.



Item number	Material	Length (cm)	Order number	Color	Packaging
81951	PVC-U	6	107640	BA - white	10 PC
	PVC-U	6	107641	BB - grey	10 PC
	PVC-U	6	107642	BC - dark brown	10 PC

Connector

Connection piece for the flexible pipe bend made of UV-resistant and impact-resistant PVC for rainwater downpipes DN 50.

Notes:
The connector with a bend creates a flexible bend of 22°. Each additional bend increases the angle by up to 23°.



Item number	Material	Length (cm)	Order number	Color	Packaging
81950	PVC-U	6	107638	BC - dark brown	10 PC
	PVC-U	6	107637	BB - grey	10 PC
	PVC-U	6	107636	BA - white	10 PC

Pipe clamp with pin galvanized/plastic coated

Pipe clamp with spike for DN 50 rainwater downpipes.

Notes:
Spike length: 110 mm



Item number	Material	Length (cm)	Order number	Color	Packaging
84118	Galvanised steel	11	104906	BA - white	25 PC
81118	Galvanised steel	11	104244	BB - grey	25 PC
83518	Galvanised steel	11	104824	BD - brown	25 PC
86518	Galvanised steel	11	104357	BC - dark brown	25 PC

Pipe clamp without pin galvanized/plastic coated

The PROTEKTOR pipe clamp with M8 thread and hexagon nut for screw pins used in DN 50 rainwater downpipes.

Notes:
Without spike.



Item number	Material	Length (cm)	Order number	Color	Packaging
84108	Galvanised steel	7	104894	BA - white	25 PC
81108	Galvanised steel	7	104236	BB - grey	25 PC
82118	Galvanised steel	7	104702	BD - brown	25 PC
86218	Galvanised steel	7	104304	BC - dark brown	25 PC

Screw pin, thread 8 mm

Screw pin for NW 50 and NW 75 pipe clamps.

Notes:
For pipe clamps without spikes.
Thread: 8 mm.



Item number	Material	Length (cm)	Order number	Color	Packaging
81318	Galvanised steel	8	104954		25 PC
81317	Galvanised steel	14	104953		25 PC
81315	Galvanised steel	20	104951		25 PC

GUTTER PIPES AND ACCESSORIES

NOMINAL DIAMETER (DN) 50

Pipe clamp without pin galvanized/plastic coated

Wooden pipe clamps with screw mounting holes for DN 50 rainwater downpipes.

Notes:
Without spike.



Item number	Material	Length (cm)	Order number	Color	Packaging
84308	Galvanised steel	8	105852	BA - white	25 PC
83508	Galvanised steel	8	105905	BD - brown	25 PC
86408	Galvanised steel	8	105853	BC - dark brown	25 PC
81418	Galvanised steel	8	105322		25 PC

Clip pipe clamp

Clip pipe clamp made of UV and shock-resistant PVC for DN 50 rainwater downpipes.



Item number	Material	Length (cm)	Order number	Color	Packaging
84128	PVC-U	6	104919	BA - white	25 PC
81128	PVC-U	6	104266	BB - grey	25 PC
83528	PVC-U	6	104835	BD - brown	25 PC
86228	PVC-U	6	104305	BC - dark brown	25 PC
88563	PVC-U	6	110922	91 - anthracite	25 PC

Transition rainwater/canal pipe

Transition piece made of UV-resistant and shockproof PVC for connecting DN 50 rainwater downpipes to drainpipes (KG pipe), 110 x 3,2 mm DN 100.



Item number	Material	Length (cm)	Order number	Color	Packaging
84029	PVC-U	13	104918	BA - white	50 PC
81129	PVC-U	13	104267	BB - grey	50 PC
83529	PVC-U	13	104837	BD - brown	50 PC
86529	PVC-U	13	104362	BC - dark brown	50 PC

Rainwater downpipe off flap

Downpipe flaps made of UV and shock-resistant PVC for DN 50 rainwater downpipes.

Notes:
Länge: 400 mm



Item number	Material	Length (cm)	Order number	Color	Packaging
84126	PVC-U	31	104917	BA - white	20 PC
81126	PVC-U	31	104265	BB - grey	20 PC
83526	PVC-U	31	104833	BD - brown	20 PC
86526	PVC-U	31	104361	BC - dark brown	20 PC

Water drain off

Water spouts made of UV and shock-resistant PVC for DN 50 rainwater downpipes.



Item number	Material	Length (cm)	Order number	Color	Packaging
84123	PVC-U	34	104911	BA - white	50 PC
81123	PVC-U	34	104320	BB - grey	50 PC
83523	PVC-U	34	104831	BD - brown	50 PC
86523	PVC-U	34	104564	BC - dark brown	50 PC

GUTTER PIPES AND ACCESSORIES

NOMINAL DIAMETER (DN) 50

Rainwater downpipe branch 45°

45° pipe junction
made of UV and shock-resistant PVC
for DN 50 to DN 50 rainwater downpipes.

Notes:
Custom-made products are possible.

Item number	Material	Length (cm)	Order number	Color	Packaging
84180	PVC-U	18	104926	BA - white	20 PC
81880	PVC-U	18	104609	BB - grey	20 PC
83580	PVC-U	18	115748	BD - brown	20 PC
86535	PVC-U	18	104364	BC - dark brown	20 PC



Rainwater downpipe branch 87°

87° pipe junction
made of UV and shock-resistant PVC
for DN 50 to DN 50 rainwater downpipes.

Notes:
Custom-made products are possible.

Item number	Material	Length (cm)	Order number	Color	Packaging
84055	PVC-U	18	104921	BA - white	20 PC
81890	PVC-U	18	104673	BB - grey	20 PC
83055	PVC-U	18	115749	BD - brown	20 PC
86155	PVC-U	18	104264	BC - dark brown	20 PC



GUTTER PIPES AND ACCESSORIES

NOMINAL DIAMETER (DN) 75

Rainwater downpipe

Rainwater downpipe including plug socket made of UV and shock-resistant PVC for DN 75 roof gutters.



Item number	Material	Length (cm)	Order number	Color	Packaging
84815	PVC-U	100	104714	BA - white	5 PCS
84125	PVC-U	200	104916	BA - white	5 PCS
84415	PVC-U	250	104377	BA - white	5 PCS
82315	PVC-U	100	104627	BB - grey	5 PCS
82015	PVC-U	200	104689	BB - grey	5 PCS
81015	PVC-U	400	104221	BB - grey	5 PCS
83715	PVC-U	100	104857	BD - brown	5 PCS
83615	PVC-U	200	104873	BD - brown	5 PCS
86715	PVC-U	100	104381	BC - dark brown	5 PCS
86115	PVC-U	200	104255	BC - dark brown	5 PCS
86124	PVC-U	250	104258	BC - dark brown	5 PCS
88573	PVC-U	100	110947	91 - anthracite	5 PCS
88560	PVC-U	200	110919	91 - anthracite	5 PCS
88561	PVC-U	250	110920	91 - anthracite	5 PCS

Rainwater downpipe bend 45°

45° pipe elbow made of UV and shock-resistant PVC for DN 75 rainwater downpipes.



Item number	Material	Length (cm)	Order number	Color	Packaging
84402	PVC-U	13	104374	BA - white	10 PC
81902	PVC-U	13	104677	BB - grey	10 PC
83616	PVC-U	13	104876	BD - brown	10 PC
86716	PVC-U	13	104383	BC - dark brown	10 PC
88570	PVC-U	13	110930	91 - anthracite	10 PC

Rainwater downpipe bend 60°

60° pipe elbow made of UV and shock-resistant PVC for DN 75 rainwater downpipes.



Item number	Material	Length (cm)	Order number	Color	Packaging
84416	PVC-U	14	104380	BA - white	10 PC
82016	PVC-U	14	104691	BB - grey	10 PC
83716	PVC-U	14	104861	BD - brown	10 PC
86616	PVC-U	14	104371	BC - dark brown	10 PC
88575	PVC-U	14	114030	91 - anthracite	10 PC

Rainwater downpipe bend 80°

80° pipe elbow made of UV and shock-resistant PVC for DN 75 rainwater downpipes.



Item number	Material	Length (cm)	Order number	Color	Packaging
84410	PVC-U	15	104376	BA - white	5 PC
81010	PVC-U	15	104218	BB - grey	5 PC
83610	PVC-U	15	104863	BD - brown	5 PC
86016	PVC-U	15	104291	BC - dark brown	5 PC
88574	PVC-U	15	111484	91 - anthracite	5 PC

GUTTER PIPES AND ACCESSORIES

NOMINAL DIAMETER (DN) 75

Pipe socket to stuck

Pipe plug socket
made of UV and shock-resistant PVC
for DN 75 rainwater downpipes.

Item number	Material	Length (cm)	Order number	Color	Packaging
84434	PVC-U	10	104430	BA - white	308 PC
81034	PVC-U	10	104228	BB - grey	308 PC
83634	PVC-U	10	104787	BD - brown	308 PC
86134	PVC-U	10	104261	BC - dark brown	308 PC
88562	PVC-U	10	110921	91 - anthracite	308 PC



Pipe clamp with pin galvanized/plastic coated

Pipe clamp with spike
for DN 75 rainwater downpipe.

Notes:
Spike length: 110 mm

Item number	Material	Length (cm)	Order number	Color	Packaging
84318	Galvanised steel	24	104367	BA - white	25 PC
82018	Galvanised steel	24	104694	BB - grey	25 PC
83618	Galvanised steel	24	104880	BD - brown	25 PC
86118	Galvanised steel	24	104257	BC - dark brown	25 PC
88609	Galvanised steel	24	114028	91 - anthracite	25 PC



Pipe clamp without pin galvanized/plastic coated

The PROTEKTOR pipe clamp with M8 thread
and hexagon nut for screw pins
used in DN 75 rainwater downpipes.

Notes:
Without spike.

Item number	Material	Length (cm)	Order number	Color	Packaging
84418	Galvanised steel	10	104392	BA - white	25 PC
81208	Galvanised steel	10	104343	BB - grey	25 PC
82618	Galvanised steel	10	104668	BD - brown	25 PC
86708	Galvanised steel	10	104373	BC - dark brown	25 PC
88610	Galvanised steel	10	114029	91 - anthracite	25 PC



Screw pin, thread 8 mm

Screw pin
for NW 50 and NW 75 pipe clamps.

Notes:
For pipe clamps without spikes.
Thread: 8 mm.

Item number	Material	Length (cm)	Order number	Color	Packaging
81318	Galvanised steel	8	104954		25 PC
81317	Galvanised steel	14	104953		25 PC
81315	Galvanised steel	20	104951		25 PC



GUTTER PIPES AND ACCESSORIES

NOMINAL DIAMETER (DN) 75

Pipe clamp without pin galvanized/plastic coated

Wooden pipe clamps with screw mounting holes for DN 75 rainwater downpipes.

Notes:
Without spike.



Item number	Material	Length (cm)	Order number	Color	Packaging
84508	Galvanised steel	10	105854	BA - white	25 PC
83708	Galvanised steel	10	105906	BD - brown	25 PC
86608	Galvanised steel	10	105855	BC - dark brown	25 PC
81419	Galvanised steel	10	105742		25 PC

Clip pipe clamp

Clip pipe clamp made of UV and shock-resistant PVC for DN 75 rainwater downpipes.



Item number	Material	Length (cm)	Order number	Color	Packaging
84428	PVC-U	9	104406	BA - white	25 PC
82028	PVC-U	9	104698	BB - grey	25 PC
83728	PVC-U	9	104874	BD - brown	25 PC
86728	PVC-U	9	104385	BC - dark brown	25 PC
88571	PVC-U	9	110931	91 - anthracite	25 PC

Transition rainwater/canal pipe

Transition pieces made of UV-resistant and shockproof PVC for connecting DN 75 rainwater downpipes to drainpipes (KG pipe), 110 x 3.2 mm DN 100.



Item number	Material	Length (cm)	Order number	Color	Packaging
81029	PVC-U	13	104300	BB - grey	50 PC
83629	PVC-U	13	104888	BD - brown	50 PC
86129	PVC-U	13	104522	BC - dark brown	50 PC

Pipe spline

Push-fit pipe spline made of UV and shock-resistant PVC for DN 75 rainwater pipes.

Notes:
Length: 460 mm



Item number	Material	Length (cm)	Order number	Color	Packaging
81027	PVC-U	46	104298	BB - grey	20 PC

Rainwater downpipe off flap

Downpipe flaps made of UV and shock-resistant PVC for DN 75 rainwater downpipes.

Notes:
Length: 400 mm



Item number	Material	Length (cm)	Order number	Color	Packaging
84426	PVC-U	40	104402	BA - white	20 PC
81026	PVC-U	40	104226	BB - grey	20 PC
83626	PVC-U	40	104885	BD - brown	20 PC
86126	PVC-U	40	104259	BC - dark brown	20 PC

GUTTER PIPES AND ACCESSORIES

NOMINAL DIAMETER (DN) 75

Rainwater downpipe branch 45°

45° pipe junction
made of UV and shock-resistant PVC
for DN 75 to DN 50 rainwater downpipes.

Notes:
Custom-made products are possible.

Item number	Material	Length (cm)	Order number	Color	Packaging
84440	PVC-U	31	104458	BA - white	25 PC
81845	PVC-U	31	104574	BB - grey	25 PC
83640	PVC-U	31	104822	BD - brown	25 PC



Rainwater downpipe branch 60°

60° pipe junction
made of UV and shock-resistant PVC
for DN 75 to DN 75 rainwater downpipes.

Notes:
Custom-made products are possible.

Item number	Material	Length (cm)	Order number	Color	Packaging
84441	PVC-U	24	115743	BA - white	25 PC
81801	PVC-U	24	115737	BB - grey	25 PC
83636	PVC-U	24	115741	BD - brown	25 PC
86135	PVC-U	24	115745	BC - dark brown	25 PC



Reducer pipe

Reducer
made of UV and shock-resistant PVC
for DN 75 to DN 50 rainwater downpipes.

Item number	Material	Length (cm)	Order number	Color	Packaging
84721	PVC-U	15	104710	BA - white	10 PC
81710	PVC-U	15	104452	BB - grey	10 PC
83220	PVC-U	15	104834	BD - brown	10 PC
86110	PVC-U	15	104254	BC - dark brown	10 PC



Leaf trap basket

Leaf trap basket
for NW 75 rainwater downpipes.

Item number	Material	Length (cm)	Order number	Color	Packaging
85415	PVC-U	8	104271	BB - grey	50 PC



GUTTER PIPES AND ACCESSORIES

NOMINAL DIAMETER (DN) 85

Rainwater downpipe

Rainwater downpipe including plug socket
made of UV and shock-resistant PVC
for DN 85 roof gutters.

Item number	Material	Length (cm)	Order number	Color	Packaging
82415	PVC-U	100	104631	BB - grey	5 PCS
82215	PVC-U	200	104610	BB - grey	5 PCS
81215	PVC-U	400	104489	BB - grey	5 PCS
83215	PVC-U	100	104820	BD - brown	5 PCS
83115	PVC-U	200	104811	BD - brown	5 PCS



Rainwater downpipe bend 45°

45° pipe elbow
made of UV and shock-resistant PVC
for DN 85 rainwater downpipes.

Item number	Material	Length (cm)	Order number	Color	Packaging
81904	PVC-U	16	104678	BB - grey	10 PC
83116	PVC-U	16	104815	BD - brown	10 PC



Rainwater downpipe bend 60°

60° pipe elbow
made of UV and shock-resistant PVC
for DN 85 rainwater downpipes.

Item number	Material	Length (cm)	Order number	Color	Packaging
82216	PVC-U	15	104611	BB - grey	10 PC
83816	PVC-U	15	104890	BD - brown	10 PC



Rainwater downpipe bend 80°

80° pipe elbow
made of UV and shock-resistant PVC
for DN 85 rainwater downpipes.

Item number	Material	Length (cm)	Order number	Color	Packaging
81210	PVC-U	21	104476	BB - grey	5 PC
83110	PVC-U	21	104800	BD - brown	5 PC



Pipe socket to stuck

Pipe plug socket
made of UV and shock-resistant PVC
for DN 85 rainwater downpipes.

Item number	Material	Length (cm)	Order number	Color	Packaging
81234	PVC-U	12	104596	BB - grey	220 PC
83134	PVC-U	12	104792	BD - brown	220 PC



GUTTER PIPES AND ACCESSORIES

NOMINAL DIAMETER (DN) 85

Pipe clamp with pin galvanized/plastic coated

Pipe clamp with spike for DN 85 rainwater downpipe.

Notes:
Spike length: 110 mm.



Item number	Material	Length (cm)	Order number	Color	Packaging
82218	Galvanised steel	25	104622	BB - grey	25 PC
83118	Galvanised steel	25	104739	BD - brown	25 PC

Transition rainwater/canal pipe

Transition pieces made of UV-resistant and shockproof PVC for connecting DN 85 rainwater downpipes to DN 100 drainpipes (KG pipe), 110 x 3.2 mm.



Item number	Material	Length (cm)	Order number	Color	Packaging
81229	PVC-U	13	104593	BB - grey	30 PC
83129	PVC-U	13	104775	BD - brown	30 PC

Pipe spline

Push-fit pipe spline made of UV and shock-resistant PVC for DN 85 rainwater downpipes.



Item number	Material	Length (cm)	Order number	Color	Packaging
81227	PVC-U	46	104588	BB - grey	15 PC

Rainwater downpipe branch 60°

60° pipe junction made of UV-resistant and shockproof PVC for DN 85 to DN 85 rainwater downpipes.

Notes:
Custom-made products are possible.



Item number	Material	Length (cm)	Order number	Color	Packaging
81830	PVC-U	24	118433	BB - grey	25 PC
83135	PVC-U	24	104795	BD - brown	25 PC

SALE

Reducer pipe

Reducer made of UV and shock-resistant PVC for DN 85 to DN 75 rainwater downpipes.



Item number	Material	Length (cm)	Order number	Color	Packaging
81711	PVC-U	16	104454	BB - grey	10 PC
83218	PVC-U	16	104825	BD - brown	10 PC

GUTTER PIPES AND ACCESSORIES

NOMINAL DIAMETER (DN) 85

Leaf trap basket

Leaf trap basket
for DN 85 and DN 100 rainwater downpipes.



Item number	Material	Length (cm)	Order number	Color	Packaging
85416	PVC-U	8	104272	BB - grey	50 PC

GUTTER PIPES AND ACCESSORIES

NOMINAL DIAMETER (DN) 100

Rainwater downpipe

Rainwater downpipe including plug socket
made of UV and shock-resistant PVC
for DN 100 roof gutters.

Item number	Material	Length (cm)	Order number	Color	Packaging
84715	PVC-U	100	104670	BA - white	5 PCS
84615	PVC-U	200	104614	BA - white	5 PCS
82615	PVC-U	100	104666	BB - grey	5 PCS
82515	PVC-U	200	104646	BB - grey	5 PCS
81515	PVC-U	400	104337	BB - grey	5 PCS
83315	PVC-U	100	104848	BD - brown	5 PCS
83015	PVC-U	200	104737	BD - brown	5 PCS
86915	PVC-U	100	104387	BC - dark brown	5 PCS
86315	PVC-U	200	104311	BC - dark brown	5 PCS



Rainwater downpipe bend 30°

30° pipe elbow
made of UV and shock-resistant PVC
for DN 100 rainwater downpipes.

Item number	Material	Length (cm)	Order number	Color	Packaging
84616	PVC-U	17	104615	BA - white	10 PC
81516	PVC-U	16	104339	BB - grey	10 PC
83024	PVC-U	17	104764	BD - brown	10 PC



Rainwater downpipe bend 45°

45° pipe elbow
made of UV and shock-resistant PVC
for DN 100 rainwater downpipes.

Item number	Material	Length (cm)	Order number	Color	Packaging
84706	PVC-U	18	104661	BA - white	10 PC
81906	PVC-U	18	104680	BB - grey	10 PC
83016	PVC-U	18	104740	BD - brown	10 PC
86916	PVC-U	18	104388	BC - dark brown	10 PC



Rainwater downpipe bend 60°

60° pipe elbow
made of UV and shock-resistant PVC
for DN 100 rainwater downpipes.

Item number	Material	Length (cm)	Order number	Color	Packaging
84716	PVC-U	17	104672	BA - white	10 PC
82516	PVC-U	17	104648	BB - grey	10 PC
83916	PVC-U	17	104896	BD - brown	10 PC
86216	PVC-U	17	104303	BC - dark brown	10 PC



GUTTER PIPES AND ACCESSORIES

NOMINAL DIAMETER (DN) 100

Rainwater downpipe bend 80°

80° pipe elbow
made of UV and shock-resistant PVC
for DN 100 rainwater downpipes.



Item number	Material	Length (cm)	Order number	Color	Packaging
81910	PVC-U	20	104682	BB - grey	5 PC

Pipe socket to stuck

Pipe plug socket
made of UV and shock-resistant PVC
for DN 100 rainwater downpipes.



Item number	Material	Length (cm)	Order number	Color	Packaging
84634	PVC-U	13	104638	BA - white	128 PC
81534	PVC-U	13	104446	BB - grey	128 PC
83034	PVC-U	13	104771	BD - brown	128 PC
86334	PVC-U	13	104327	BC - dark brown	128 PC

Pipe clamp with pin galvanized/plastic coated

Pipe clamp with spike
for DN 100 rainwater downpipe.

Notes:
Spike length: 110 mm.



Item number	Material	Length (cm)	Order number	Color	Packaging
84618	Galvanised steel	27	104617	BA - white	25 PC
82518	Galvanised steel	27	104651	BB - grey	25 PC
83018	Galvanised steel	27	104751	BD - brown	25 PC
86318	Galvanised steel	27	104313	BC - dark brown	25 PC

Pipe clamp without pin galvanized/plastic coated

The PROTEKTOR pipe clamp with M10 thread
and hexagon nut for screw pins
used in DN 100 rainwater downpipes.

Notes:
Without spike.



Item number	Material	Length (cm)	Order number	Color	Packaging
84608	Galvanised steel	14	104598	BA - white	25 PC
81508	Galvanised steel	14	104325	BB - grey	25 PC
83308	Galvanised steel	14	104842	BD - brown	25 PC
86308	Galvanised steel	14	104309	BC - dark brown	25 PC

Screw pin, thread M10

Screw pin
for NW 100 and NW 125 pipe clamps.

Notes:
For pipe clamps without spikes.
Thread: 10 mm.



Item number	Material	Length (cm)	Order number	Color	Packaging
81314	Galvanised steel	14	118646		50 PC
81319	Galvanised steel	20	104955		25 PC
81316	Galvanised steel	29	104952		25 PC

GUTTER PIPES AND ACCESSORIES

NOMINAL DIAMETER (DN) 100

Transition rainwater/canal pipe

Transition pieces
made of UV-resistant and shockproof PVC
for connecting DN 100 rainwater downpipes to
drainpipes (KG pipe), 110 x 3.2 mm DN 100.

Item number	Material	Length (cm)	Order number	Color	Packaging
84629	PVC-U	13	104632	BA - white	60 PC
81529	PVC-U	13	104438	BB - grey	60 PC
83029	PVC-U	13	104768	BD - brown	60 PC
86329	PVC-U	13	104556	BC - dark brown	60 PC



Transition piece

Transition piece
made of UV and shock-resistant PVC
for connecting roof gullies to DN 100 rainwater
pipes.

Item number	Material	Length (cm)	Order number	Color	Packaging
81025	PVC-U	16	104295	BB - grey	30 PC



Pipe spline

Push-fit pipe spline
made of UV and shock-resistant PVC
for DN 100 rainwater downpipes.

Item number	Material	Length (cm)	Order number	Color	Packaging
81527	PVC-U	46	104423	BB - grey	12 PC
83027	PVC-U	46	104766	BD - brown	12 PC



Rainwater downpipe branch 45°

45° pipe junction
made of UV and shock-resistant PVC
for DN 100 to DN 50 rainwater downpipes.

Notes:
Custom-made products are possible.

Item number	Material	Length (cm)	Order number	Color	Packaging
84640	PVC-U	32	104647	BA - white	15 PC
81840	PVC-U	32	104573	BB - grey	15 PC



Rainwater downpipe branch 60°

60° pipe junction
made of UV and shock-resistant PVC
for DN 100 to DN 75 rainwater downpipes.

Notes:
Custom-made products are possible.

Item number	Material	Length (cm)	Order number	Color	Packaging
81805	PVC-U	24	115738	BB - grey	15 PC
83650	PVC-U	24	115742	BD - brown	15 PC
86335	PVC-U	24	104331	BC - dark brown	15 PC



SALE

GUTTER PIPES AND ACCESSORIES

NOMINAL DIAMETER (DN) 100

Rainwater downpipe branch 60°

60° pipe junction
made of UV and shock-resistant PVC
for DN 100 to DN 100 rainwater downpipes.

Notes:
Custom-made products are possible.



Item number	Material	Length (cm)	Order number	Color	Packaging
84606	PVC-U	24	115744	BA - white	12 PC
81806	PVC-U	24	115739	BB - grey	12 PC
83150	PVC-U	24	115740	BD - brown	12 PC
86935	PVC-U	24	115747	BC - dark brown	12 PC

Reducer pipe

Reducer
made of UV and shock-resistant PVC
for DN 100 to DN 75 rainwater downpipes.



Item number	Material	Length (cm)	Order number	Color	Packaging
84720	PVC-U	16	104697	BA - white	10 PC
81712	PVC-U	16	104457	BB - grey	10 PC
83221	PVC-U	16	104836	BD - brown	10 PC
86310	PVC-U	16	104310	BC - dark brown	10 PC

Reducer pipe

Reducer
made of UV and shock-resistant PVC
for DN 100 to DN 85 rainwater downpipes.



Item number	Material	Length (cm)	Order number	Color	Packaging
81713	PVC-U	16	104460	BB - grey	10 PC
83219	PVC-U	16	104829	BD - brown	10 PC

Leaf trap basket

Leaf trap basket
for DN 85 and DN 100 rainwater downpipes.



Item number	Material	Length (cm)	Order number	Color	Packaging
85416	PVC-U	8	104272	BB - grey	50 PC

GUTTER PIPES AND ACCESSORIES

NOMINAL DIAMETER (DN) 125

Rainwater downpipe

Downpipe including plug socket
made of UV and shock-resistant PVC
for DN 125 roof gutters.



Item number	Material	Length (cm)	Order number	Color	Packaging
81815	PVC-U	400	104540	BB - grey	3 PCS

Rainwater downpipe bend 45°

45° pipe elbow
made of UV and shock-resistant PVC
for DN 125 rainwater downpipes.



Item number	Material	Length (cm)	Order number	Color	Packaging
81908	PVC-U	21	104681	BB - grey	5 PC

Rainwater downpipe bend 60°

60° pipe elbow
made of UV and shock-resistant PVC
for DN 125 rainwater downpipes.



Item number	Material	Length (cm)	Order number	Color	Packaging
82816	PVC-U	23	104712	BB - grey	5 PC

Pipe socket to stuck

Pipe plug socket
made of UV and shock-resistant PVC
for DN 125 half-round gutters.



Item number	Material	Length (cm)	Order number	Color	Packaging
81834	PVC-U	16	107856	BB - grey	63 PC

Pipe clamp with pin galvanized/plastic coated

Pipe clamp with spike
for DN 125 rainwater downpipes.

Notes:
Stiftlänge: 110 mm.



Item number	Material	Length (cm)	Order number	Color	Packaging
82818	Galvanised steel	27	104715	BB - grey	25 PC

GUTTER PIPES AND ACCESSORIES

NOMINAL DIAMETER (DN) 125

Pipe clamp without pin galvanized

The PROTEKTOR pipe clamp with M10 thread and hexagon nut for screw pins used in DN 125 rainwater downpipes.

Notes:
Without spike.



Item number	Material	Length (cm)	Order number	Color	Packaging
82918	Galvanised steel	10	104727		25 PC

Screw pin, thread M10

Screw pin for NW 100 and NW 125 pipe clamps.

Notes:
For pipe clamps without spikes.
Thread: 10 mm.



Item number	Material	Length (cm)	Order number	Color	Packaging
81314	Galvanised steel	14	118646		50 PC
81319	Galvanised steel	20	104955		25 PC
81316	Galvanised steel	29	104952		25 PC

Pipe spline

Push-fit pipe spline made of UV and shock-resistant PVC for DN 125 rainwater downpipes.



Item number	Material	Length (cm)	Order number	Color	Packaging
81827	PVC-U	52	104567	BB - grey	8 PC

Rainwater downpipe branch 60°

60° pipe junction made of UV and shock-resistant PVC for DN 125 to DN 100 rainwater downpipes.

Notes:
Custom-made products are possible.



Item number	Material	Length (cm)	Order number	Color	Packaging
81808	PVC-U	46	104528	BB - grey	6 PC

Rainwater downpipe branch 60°

60° pipe junction made of UV and shock-resistant PVC for DN 125 to DN 125 rainwater downpipes.

Notes:
Custom-made products are possible.



Item number	Material	Length (cm)	Order number	Color	Packaging
81807	PVC-U	46	104526	BB - grey	5 PC

GUTTER PIPES AND ACCESSORIES

NOMINAL DIAMETER (DN) 125

Reducer pipe

Reducer
made of UV and shock-resistant PVC
for DN 125 to DN 100 rainwater downpipes.



Item number	Material	Length (cm)	Order number	Color	Packaging
81714	PVC-U	18	104462	BB - grey	30 PC

GUTTER PIPES AND ACCESSORIES

ROOFING SET / DOWNPIPE SET

Rainwater downpipe set for wintergarden

Downpipe sets for sunrooms made of UV and shock-resistant PVC for DN 50 half-round gutters.

Notes:
200-cm rainwater downpipe including plug socket, 45° pipe elbow, clip pipe clamps, screw sockets.



Item number	Material	Length (cm)	Order number	Color	Packaging
84000	PVC-U	200	104912	BA - white	1 PC
86600	PVC-U	200	105379	BC - dark brown	1 PC
86602	PVC-U	200	110903	91 - anthracite	1 PC

Rainwater downpipe set for wintergarden

Downpipe sets for sunrooms made of UV and shock-resistant PVC for DN 75 half-round gutters.

Notes:
250-cm downpipe including plug socket, 45° pipe elbow, 2 clip pipe clamps, screw sockets.



Item number	Material	Length (cm)	Order number	Color	Packaging
84400	PVC-U	250	104370	BA - white	1 PC
86601	PVC-U	250	105381	BC - dark brown	1 PC
86603	PVC-U	250	110904	91 - anthracite	1 PC

CARPORT GUTTERS

Carport gutter

Non-perforated carport gutter made of UV-resistant and shockproof PVC.
Width: 115 mm
Height: 60 mm
Leg width: 40 mm

Notes:
Bottom width: 115 mm
Processing instructions: The minimum distance between perforations is 20 mm. Special adhesive no. 81250 should be used for all box-shaped gutter components.



Item number	Material	Length (cm)	Order number	Color	Packaging
SALE 82600	PVC-U	298	105465	BD - brown	1 PCS
	PVC-U	331	105464	BD - brown	1 PCS

Carport gutter punched

Perforated carport gutter made of UV-resistant and shockproof PVC.
Width: 115 mm
Height: 60 mm
Leg width: 40 mm

Notes:
Bottom width: 115 mm
Processing instructions: Standard perforations 24 mm. Special adhesive no. 81250 should be used for all box-shaped gutter components.



Item number	Material	Length (cm)	Order number	Color	Packaging
SALE 82603	PVC-U	331	105524	BD - brown	1 PCS

Carport gutter endpiece

Carport gutter end piece made of UV-resistant and shockproof PVC.
Width: 115 mm

Notes:
Bottom width: 115 mm
Processing instructions: Right and left gutter end. Special adhesive no. 81250 should be used for all box-shaped gutter components.



Item number	Material	Length (cm)	Order number	Color	Packaging
82613	PVC-U	12	104664	BD - brown	10 PC

Carport gutter expansion connector

Carport gutter expansion connector made of UV-resistant and shockproof PVC.
Width: 115 mm

Notes:
Bottom width: 115 mm
Processing instructions: Special adhesive no. 81250 should be used for all box-shaped gutter components.



Item number	Material	Length (cm)	Order number	Color	Packaging
82620	PVC-U	21	104704	BD - brown	14 PC

Box gutter screw connector

Box-shaped gutter screw socket made of UV-resistant and shockproof PVC for NW 83 box-shaped gutters to DN 75 down-pipes.

Notes:
Auch für kastenförmige Metallrinnen.
Auch für Übergänge auf HT-Rohre.
Processing instructions: Also suitable for box-shaped metal gutters.



Item number	Material	Length (cm)	Order number	Color	Packaging
83632	PVC-U	6	106715	BD - brown	10 PC

CARPORT GUTTERS

Box gutter screw connector

box-shaped gutter screw socket
made of UV-resistant and shockproof PVC
for NW 83 box-shaped gutters to DN 100 down-
pipes,

Notes:

Auch für kastenförmige Metallrinnen.
Auch für Übergänge auf HT-Rohre.

Processing instructions: Also suitable for box-
shaped metal gutters.



Item number	Material	Length (cm)	Order number	Color	Packaging
83132	PVC-U	11	107359	BD - brown	10 PC

LEAF TRAPS

Leaf trap grid NW 100 + NW 125

Leaf trap grid made of UV and shock-resistant PE for NW 100 to NW 125 half-round gutters.

Notes:
Do not use leaf guards made of plastic on purely metal roofs due to the heat that may develop through long-term sun exposure.

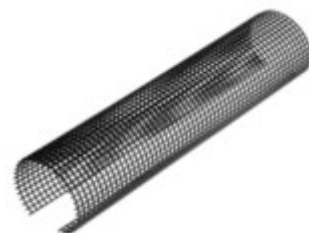

Item number	Material	Length (cm)	Order number	Color	Packaging
85518	PE	200	112357	90 - black	10 PCS
	PE	300	104274	90 - black	10 PCS

Leaf trap grid NW 100 + NW 125

Leaf trap grid on the roll, made of UV and shock-resistant PE for NW 100 to NW 125 half-round gutters.

Notes:
Do not use leaf guards made of plastic on purely metal roofs due to the heat that may develop through long-term sun exposure.



Item number	Material	Length (cm)	Order number	Color	Packaging
85520	PE	300	117415	90 - black	1 ROL

Hedgehog gutter brush

Hedgehog gutter brush for NW 100 and NW 125 half-round gutters.

Notes:
Not suited for copper gutters.



Item number	Material	Length (cm)	Order number	Color	Packaging
85562		120	109648	90 - black	28 PC

Leaf trap stripe

Leaf guard for gutter sizes of NW 100 to NW 150.

Notes:
Do not use leaf guards made of plastic on purely metal roofs due to the heat that may develop through long-term sun exposure.



Item number	Material	Length (cm)	Order number	Color	Packaging
85558	PP	100	109464	90 - black	30 PCS
85559	PP	100	109465	BB - grey	30 PCS
85560	PP	100	109466	BD - brown	30 PCS

Leaf trap grid NW 150 + NW 180

Leaf trap grid for gutter sizes of NW 150 to NW 180.

Notes:
Do not use leaf guards made of plastic on purely metal roofs due to the heat that may develop through long-term sun exposure.

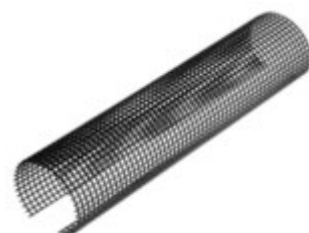

Item number	Material	Length (cm)	Order number	Color	Packaging
85519	PE	200	112356	90 - black	10 PCS
	PE	300	104275	90 - black	10 PCS

LEAF TRAPS

Leaf trap grid NW 68

Leaf trap grid
made of UV and shock-resistant PE
for NW 100 to NW 125 half-round gutters.

Notes:
Do not use leaf guards made of plastic
on purely metal roofs due to the heat that may
develop through long-term sun exposure.

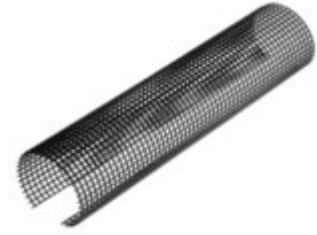

Item number	Material	Length (cm)	Order number	Color	Packaging
85516	PE	200	117791	90 - black	10 PCS

Leaf trap grid NW 83

Leaf trap grid
made of UV and shock-resistant PE
for NW 100 to NW 125 half-round gutters.

Notes:
Do not use leaf guards made of plastic
on purely metal roofs due to the heat that may
develop through long-term sun exposure.

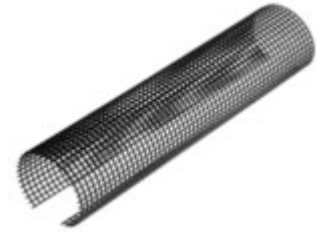

Item number	Material	Length (cm)	Order number	Color	Packaging
85517	PE	200	117792	90 - black	10 PCS

ROOF PLATES

Flashing with water check

Flashing with water check for various roof coverings and roof slopes.

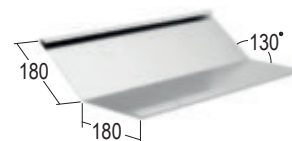

Item number	Material	Length (cm)	Order number	Color	Package/ Large pack
86410	Aluminum	200	112102		1 PC / 100 BUN

Chape with water drip

Chape with water check for various roof coverings and roof slopes.

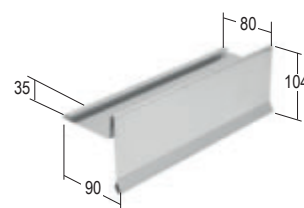

Item number	Material	Length (cm)	Order number	Color	Package/ Large pack
86412	Aluminum	200	112106		1 PC / 100 BUN

Chape without water drip

Chape without water check can universally be used for various sealing membranes.

Processing instructions: Dachabdichtungsbahnen müssen mit dem Blech verklebt werden.

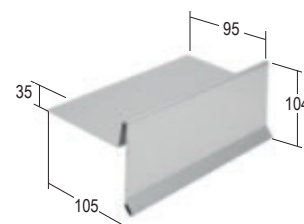

Item number	Material	Length (cm)	Order number	Color	Package/ Large pack
86414	Aluminum	200	112107		1 PC / 100 BUN

Gutter hanging system without water check

Gutter hanging system with water check for various roof coverings and roof slopes.

Processing instructions: Dachabdichtungsbahnen müssen mit dem Rinneneinhang verklebt werden.

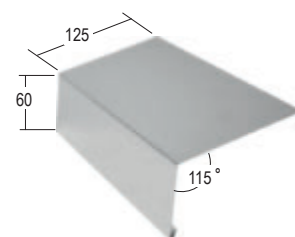

Item number	Material	Length (cm)	Order number	Color	Package/ Large pack
86416	Aluminum	200	112108		1 PC / 100 BUN

Roof stripe

200-mm roof strips canted on one side.

Processing instructions: Dachabdichtungsbahnen müssen mit dem Rinneneinhang verklebt werden.



Item number	Material	Length (cm)	Order number	Color	Package/ Large pack
81341	PVC-U	200	105586	BB - grey	10 PCS / 90 BUN
83341	PVC-U	200	105589	BD - brown	10 PCS / 30 BUN
86641	PVC-U	200	105388	BC - dark brown	10 PCS / 30 BUN

ROOF PLATES

Roof stripe

200-mm roof strips canted on two sides.

Item number	Material	Length (cm)	Order number	Color	Package/ Large pack
81321	PVC-U	200	105876	BB - grey	10 PCS / 30 BUN
83321	PVC-U	200	105585	BD - brown	10 PCS / 30 BUN
86621	PVC-U	200	105588	BC - dark brown	10 PCS / 30 BUN



Eaves profile

Eaves profile 85 x 30 mm, 135 °. For the optimal removal of moisture that gets onto the underlay or underlay through the ingress of rain, drifting snow or condensate.

Item number	Material	Length (cm)	Order number	Color	Package/ Large pack
9385	Aluminum	250	116681	NA - natur	10 PCS / 140 BUN

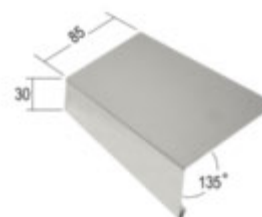

Angle plate with water check

Angle panel with water check for transitions between suitable roofs to vertical walls.

Item number	Material	Length (cm)	Order number	Color	Package/ Large pack
86418	Aluminum	200	112109		1 PC / 100 BUN

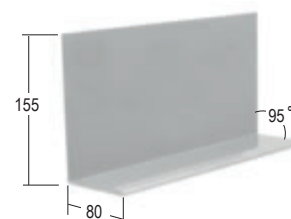

Angle plate without water check

Angle panel with water check for transitions between horizontal and vertical construction components.

Processing instructions: Dachabdichtungsbahnen müssen mit dem Rinneneinhang verklebt werden.

Item number	Material	Length (cm)	Order number	Color	Package/ Large pack
86420	Aluminum	200	112110		1 PC / 100 BUN

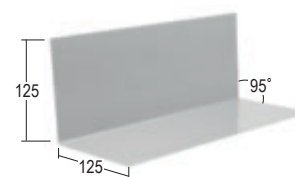

Eaves strip without water drip

Eaves strip without water check for use as a metal sheet create transitions from roof surfaces along the eaves to the gutter.

Processing instructions: Dachabdichtungsbahnen müssen mit dem Rinneneinhang verklebt werden.

Item number	Material	Length (cm)	Order number	Color	Package/ Large pack
86422	Aluminum	200	112111		1 PC / 100 BUN

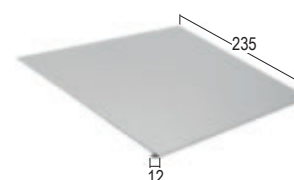

ROOF PLATES

Ridge sheet

First sheet
for bitument shingles, waterproofing membranes
and slate roofing.



Item number	Material	Length (cm)	Order number	Color	Package/ Large pack
86424	Aluminum	200	112112		1 PC / 100 BUN

Capping strip

Capping strip
for clean transitions between horizontal and
vertical construction components.



Item number	Material	Length (cm)	Order number	Color	Package/ Large pack
86426	Aluminum	200	112113		1 PC / 100 BUN

Cover profile

Coverage profile
for the optimum degree of coverage and enclosure
for panels of up to 25 mm.

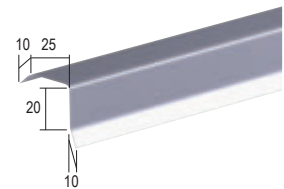

Item number	Material	Length (cm)	Order number	Color	Package/ Large pack
86428	Aluminum	200	112225		1 PC / 100 BUN

Cover profile

Coverage profile
for the optimum degree of coverage and enclosure
for panels of up to 35 mm.

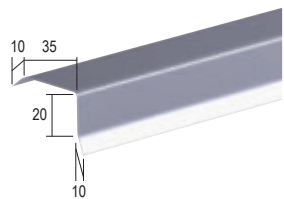

Item number	Material	Length (cm)	Order number	Color	Package/ Large pack
86429	Aluminum	200	112226		1 PC / 100 BUN

Cover profile

Attika cover profile
for achieving optimal coverage and enclosure
for panels of up to 45 mm.

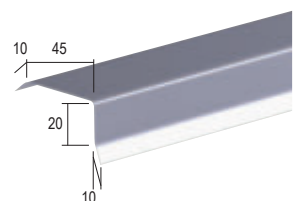

Item number	Material	Length (cm)	Order number	Color	Package/ Large pack
86430	Aluminum	200	112227		1 PC / 100 BUN

PRODUCT INFORMATION

ALL AROUND THE GARDEN HOUSE ROOF



EUROPE'S MOST COMPREHENSIVE ASSORTMENT OF ROOF DRAINAGE PRODUCTS

With the PROTEKTOR roof gutter system, nothing is left to chance. Our decades of experience in manufacturing plastic profiles and roof gutter systems provide you with the security of a high-quality, long-lasting product. The easy-to-assemble half-round gutter set contains all of the necessary drainage components, for up to 50 m² per roof side, for everything from the roof to the ground. Everything, just as you want it.

- ▶ Half-round gutter NW 100
- ▶ Rainwater downpipe DN 75, plus accessories
- ▶ Colours: dark brown, white, grey, anthracite
- ▶ Complete for both sides

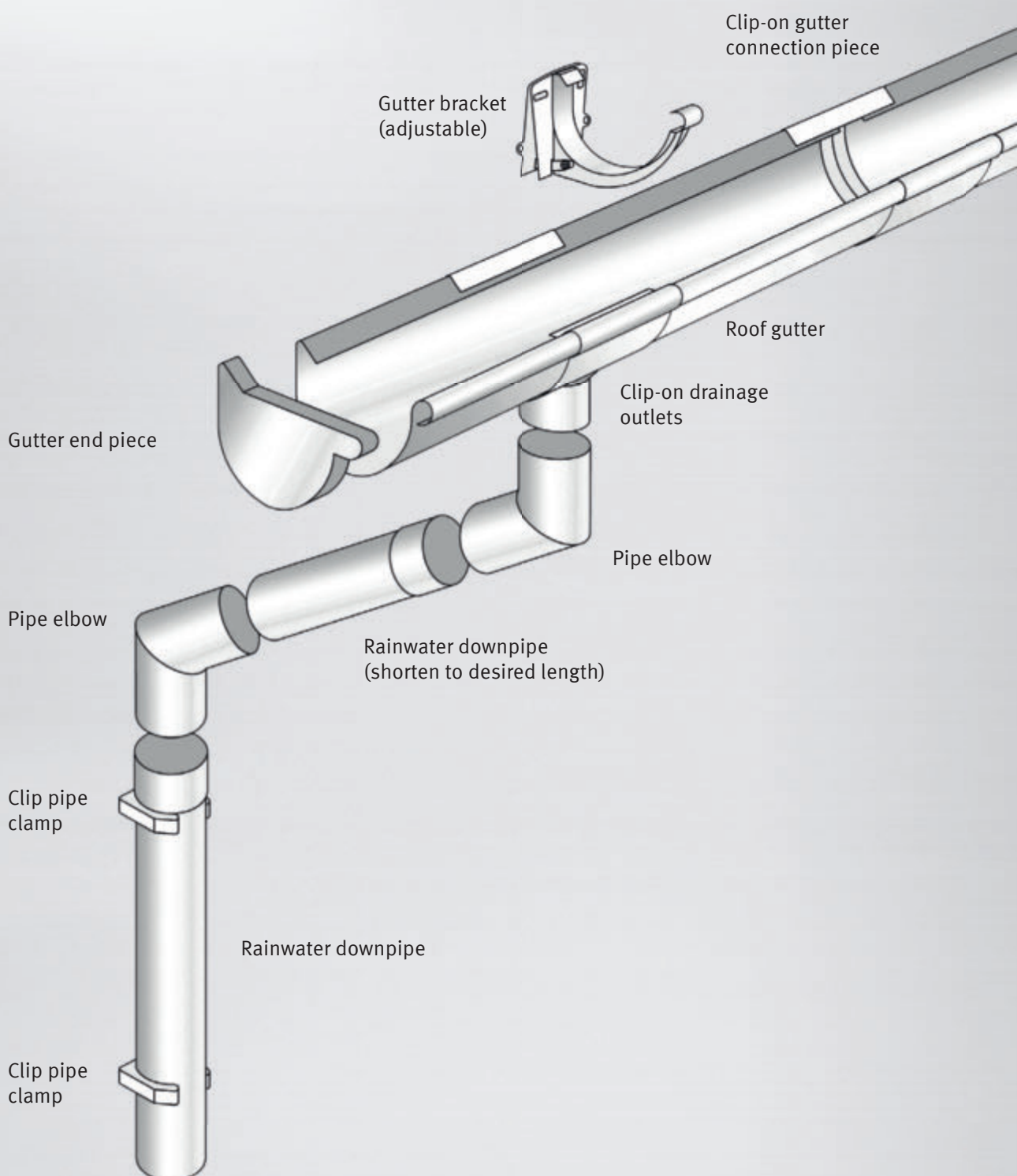

GUTTER SETS

SETS HALF-ROUND GUTTER GARDEN SHEDS WITH PITCHED ROOF (NW) 100

Gutter set for garden house up to 3 m

Roof gutter set for garden houses, with roof lengths of up to 3.0 m, for NW 100 half-round gutters.

Item number	Material	Order number	Color	Packaging
85911	PVC-U	109271	BA - white	1 PC
85909	PVC-U	109264	BB - grey	1 PC
85831	PVC-U	106003	BC - dark brown	1 PC
85970	PVC-U	114003	91 - anthracite	1 PC



Gutter set for garden house up to 4 m

Roof gutter set for garden houses, with roof lengths of up to 4.0 m, for NW 100 half-round gutters.

Item number	Material	Order number	Color	Packaging
85906	PVC-U	108959	BA - white	1 PC
85904	PVC-U	108945	BB - grey	1 PC
85832	PVC-U	106004	BC - dark brown	1 PC
85972	PVC-U	114005	91 - anthracite	1 PC



Gutter set for garden house up to 5 m

Roof gutter set for garden houses, with roof lengths of up to 5.0 m, for NW 100 half-round gutters.

Item number	Material	Order number	Color	Packaging
85907	PVC-U	108973	BA - white	1 PC
85901	PVC-U	108934	BB - grey	1 PC
85834	PVC-U	106006	BC - dark brown	1 PC
85974	PVC-U	114007	91 - anthracite	1 PC



Gutter set for garden house up to 6 m

Roof gutter set for garden houses, with roof lengths of up to 6.0 m, for NW 100 half-round gutters.

Item number	Material	Order number	Color	Packaging
85910	PVC-U	109269	BA - white	1 PC
85902	PVC-U	108938	BB - grey	1 PC
85859	PVC-U	106240	BC - dark brown	1 PC
85976	PVC-U	114009	91 - anthracite	1 PC



Gutter set for garden house up to 7 m

Roof gutter set for garden houses, with roof lengths of up to 7.0 m, for NW 100 half-round gutters.

Item number	Material	Order number	Color	Packaging
85954	PVC-U	113685	BA - white	1 PC
85943	PVC-U	110500	BB - grey	1 PC
85864	PVC-U	106301	BC - dark brown	1 PC
85978	PVC-U	114011	91 - anthracite	1 PC



GUTTER SETS

SETS HALF-ROUND GUTTER GARDEN SHEDS WITH PITCHED ROOF (NW) 100

Gutter set for garden house up to 8 m

Roof gutter set for garden houses,
with roof lengths of up to 8.0 m,
for NW 100 half-round gutters.



Item number	Material	Order number	Color	Packaging
85920	PVC-U	109797	BA - white	1 PC
85944	PVC-U	110501	BB - grey	1 PC
85869	PVC-U	106402	BC - dark brown	1 PC
85980	PVC-U	114013	91 - anthracite	1 PC

GUTTER SETS

SETS HALF-ROUND GUTTER TERRACE/CANOPY (NW) 100

Gutter set for terrace roofing up to 3 m

Gutter set for terrace coverings, made of UV and shock-resistant PVC, for NW 100 half-round gutters.

Notes:
200-cm downpipe plus accessories.

Item number	Material	Order number	Color	Packaging
85710	PVC-U	118126	BA - white	1 PC
85703	PVC-U	118119	BB - grey	1 PC
85712	PVC-U	118128	BC - dark brown	1 PC
85708	PVC-U	118124	91 - anthracite	1 PC



Gutter set for terrace roofing up to 4 m

Gutter set for terrace coverings, made of UV and shock-resistant PVC, for NW 100 half-round gutters.

Notes:
200-cm downpipe plus accessories.

Item number	Material	Order number	Color	Packaging
85890	PVC-U	108261	BA - white	1 PC
85702	PVC-U	118118	BB - grey	1 PC
85889	PVC-U	108260	BC - dark brown	1 PC
85707	PVC-U	118123	91 - anthracite	1 PC



Gutter set for terrace roofing up to 5 m

Gutter set for terrace coverings, made of UV and shock-resistant PVC, for NW 100 half-round gutters.

Notes:
200-cm downpipe plus accessories.

Item number	Material	Order number	Color	Packaging
85892	PVC-U	108263	BA - white	1 PC
85701	PVC-U	118117	BB - grey	1 PC
85891	PVC-U	108262	BC - dark brown	1 PC
85706	PVC-U	118122	91 - anthracite	1 PC



Gutter set for terrace roofing up to 6 m

Gutter set for terrace coverings, made of UV and shock-resistant PVC, for NW 100 half-round gutters.

Notes:
200-cm downpipe plus accessories.

Item number	Material	Order number	Color	Packaging
85894	PVC-U	108265	BA - white	1 PC
85700	PVC-U	118116	BB - grey	1 PC
85893	PVC-U	108264	BC - dark brown	1 PC
85705	PVC-U	118121	91 - anthracite	1 PC



Gutter set for terrace roofing up to 8 m

Gutter set for terrace coverings, made of UV and shock-resistant PVC, for NW 100 half-round gutters.

Notes:
200-cm downpipe plus accessories.

Item number	Material	Order number	Color	Packaging
85709	PVC-U	118125	BA - white	1 PC
85699	PVC-U	118115	BB - grey	1 PC
85711	PVC-U	118127	BC - dark brown	1 PC
85704	PVC-U	118120	91 - anthracite	1 PC



GUTTER SETS

SETS BOXGUTTER GARDEN SHEDS WITH PITCHED ROOF (NW) 68

Box gutter set for garden house up to 2 m

Roof gutter set for garden houses with roof lengths of up to 2.0 m, made of UV-resistant and shockproof PVC for NW 68 box-shaped gutters.

Notes:

Due to technical reasons, all box-shaped gutter components have to be connected using special adhesive no. 81250, included in the set.

Processing instructions: The special adhesive no. 81250 must be used for all box gutter parts.



Item number	Material	Order number	Color	Packaging
85959	PVC-U	113690	BA - white	1 PC
85960	PVC-U	113691	BB - grey	1 PC
85856	PVC-U	106230	BC - dark brown	1 PC

Box gutter set for garden house up to 3 m

Roof gutter set for garden houses with roof lengths of up to 3.0 m, made of UV-resistant and shockproof PVC for NW 68 box-shaped gutters.

Notes:

Due to technical reasons, all box-shaped gutter components have to be connected using special adhesive no. 81250, included in the set.

Processing instructions: The special adhesive no. 81250 must be used for all box gutter parts.



Item number	Material	Order number	Color	Packaging
85930	PVC-U	109839	BA - white	1 PC
85903	PVC-U	108944	BB - grey	1 PC
85837	PVC-U	105999	BC - dark brown	1 PC

Box gutter set for garden house up to 4 m

Roof gutter set for garden houses with roof lengths of up to 4.0 m, made of UV-resistant and shockproof PVC for NW 68 box-shaped gutters.

Processing instructions: The special adhesive no. 81250 must be used for all box gutter parts.



Item number	Material	Order number	Color	Packaging
85912	PVC-U	109441	BA - white	1 PC
85905	PVC-U	108960	BB - grey	1 PC
85839	PVC-U	106001	BC - dark brown	1 PC

Box gutter set for garden house up to 5 m

Roof gutter set for garden houses with roof lengths of up to 5.0 m, made of UV-resistant and shockproof PVC for NW 68 box-shaped gutters.

Processing instructions: The special adhesive no. 81250 must be used for all box gutter parts.



Item number	Material	Order number	Color	Packaging
85948	PVC-U	112301	BA - white	1 PC
85966	PVC-U	113697	BB - grey	1 PC
85873	PVC-U	106437	BC - dark brown	1 PC

GUTTER SETS

SETS BOXGUTTER GARDEN SHEDS WITH PITCHED ROOF (NW) 68

Box gutter set for garden house up to 6 m

Roof gutter set for garden houses with roof lengths of up to 5.5 m, made of UV-resistant and shockproof PVC for NW 68 box-shaped gutters.

Notes:

Due to technical reasons, all box-shaped gutter components have to be connected using special adhesive no. 81250, included in the set.

Processing instructions: The special adhesive no. 81250 must be used for all box gutter parts.



Item number	Material	Order number	Color	Packaging
85685	PVC-U	118315	BA - white	1 PC
85686	PVC-U	118319	BB - grey	1 PC
85684	PVC-U	118311	BC - dark brown	1 PC

GUTTER SETS

SETS BOXGUTTERS TERRACE/CANOPY (NW) 68

Box gutter set for carport/terrace roofing up to 3 m

Roof gutter set for garden houses with roof lengths of up to 3.0 m, made of UV-resistant and shockproof PVC for NW 68 box-shaped gutters.

Notes:

Due to technical reasons, all box-shaped gutter components have to be connected using special adhesive no. 81250, included in the set.

Processing instructions: The special adhesive no. 81250 must be used for all box gutter parts.



Item number	Material	Order number	Color	Packaging
85695	PVC-U	118110	BA - white	1 PC
85698	PVC-U	118113	BB - grey	1 PC
85689	PVC-U	118104	BD - brown	1 PC
85692	PVC-U	118107	BC - dark brown	1 PC

Box gutter set for carport/terrace roofing up to 4 m

Roof gutter set for garden houses with roof lengths of up to 3.0 m, made of UV-resistant and shockproof PVC for NW 68 box-shaped gutters.

Notes:

Due to technical reasons, all box-shaped gutter components have to be connected using special adhesive no. 81250, included in the set.

Processing instructions: The special adhesive no. 81250 must be used for all box gutter parts.



Item number	Material	Order number	Color	Packaging
85694	PVC-U	118109	BA - white	1 PC
85697	PVC-U	118112	BB - grey	1 PC
85688	PVC-U	118103	BD - brown	1 PC
85691	PVC-U	118106	BC - dark brown	1 PC

Box gutter set for carport/terrace roofing up to 5 m

Roof gutter set for garden houses with roof lengths of up to 3.0 m, made of UV-resistant and shockproof PVC for NW 68 box-shaped gutters.

Notes:

Due to technical reasons, all box-shaped gutter components have to be connected using special adhesive no. 81250, included in the set.

Processing instructions: The special adhesive no. 81250 must be used for all box gutter parts.



Item number	Material	Order number	Color	Packaging
85693	PVC-U	118108	BA - white	1 PC
85696	PVC-U	118111	BB - grey	1 PC
85687	PVC-U	118102	BD - brown	1 PC
85690	PVC-U	118105	BC - dark brown	1 PC

GUTTER SETS

SETS BOXGUTTERS GARDEN SHEDS (NW) 83

Box gutter set for garden house up to 3 m

Roof gutter set for garden houses with roof lengths of up to 3.0 m, made of UV-resistant and shockproof PVC for NW 83 box-shaped gutters.

Notes:

Due to technical reasons, all box-shaped gutter components have to be connected using special adhesive no. 81250, included in the set.

Processing instructions: The special adhesive no. 81250 must be used for all box gutter parts.



Item number	Material	Order number	Color	Packaging
85851	PVC-U	118134	BB - grey	1 PC
85850	PVC-U	118133	BD - brown	1 PC

Box gutter set for garden house up to 4 m

Roof gutter set for garden houses with roof lengths of up to 3.0 m, made of UV-resistant and shockproof PVC for NW 68 box-shaped gutters.

Notes:

Due to technical reasons, all box-shaped gutter components have to be connected using special adhesive no. 81250, included in the set.

Processing instructions: The special adhesive no. 81250 must be used for all box gutter parts.



Item number	Material	Order number	Color	Packaging
85849	PVC-U	118132	BB - grey	1 PC
85848	PVC-U	118131	BD - brown	1 PC

Box gutter set for garden house up to 5 m

Roof gutter set for garden houses with roof lengths of up to 5.0 m, made of UV-resistant and shockproof PVC for NW 83 box-shaped gutters.

Notes:

Due to technical reasons, all box-shaped gutter components have to be connected using special adhesive no. 81250, included in the set.

Processing instructions: The special adhesive no. 81250 must be used for all box gutter parts.



Item number	Material	Order number	Color	Packaging
85847	PVC-U	118130	BB - grey	1 PC
85846	PVC-U	118129	BD - brown	1 PC

GUTTER SETS

SETS BOXGUTTERS CARPORT/TERRACE (NW) 83

Box gutter set for carport/terrace roofing up to 3 m

Roof gutter set for garden houses with roof lengths of up to 3.0 m, made of UV-resistant and shockproof PVC for NW 68 box-shaped gutters.

Notes:

Due to technical reasons, all box-shaped gutter components have to be connected using special adhesive no. 81250, included in the set.

Processing instructions: The special adhesive no. 81250 must be used for all box gutter parts.



Item number	Material	Order number	Color	Packaging
85984	PVC-U	117051	BB - grey	1 PC
85987	PVC-U	117199	BD - brown	1 PC

Box gutter set for carport/terrace roofing up to 4 m

Roof gutter set for garden houses with roof lengths of up to 3.0 m, made of UV-resistant and shockproof PVC for NW 68 box-shaped gutters.

Notes:

Due to technical reasons, all box-shaped gutter components have to be connected using special adhesive no. 81250, included in the set.

Processing instructions: The special adhesive no. 81250 must be used for all box gutter parts.



Item number	Material	Order number	Color	Packaging
85985	PVC-U	117197	BB - grey	1 PC
85988	PVC-U	117200	BD - brown	1 PC

Box gutter set for carport/terrace roofing up to 5 m

Roof gutter set for garden houses with roof lengths of up to 3.0 m, made of UV-resistant and shockproof PVC for NW 68 box-shaped gutters.

Notes:

Due to technical reasons, all box-shaped gutter components have to be connected using special adhesive no. 81250, included in the set.

Processing instructions: The special adhesive no. 81250 must be used for all box gutter parts.



Item number	Material	Order number	Color	Packaging
85986	PVC-U	117198	BB - grey	1 PC
85989	PVC-U	117201	BD - brown	1 PC

Box gutter set for carport/terrace roofing up to 6 m

Roof gutter set for garden houses with roof lengths of up to 3.0 m, made of UV-resistant and shockproof PVC for NW 68 box-shaped gutters.

Notes:

Due to technical reasons, all box-shaped gutter components have to be connected using special adhesive no. 81250, included in the set.

Processing instructions: The special adhesive no. 81250 must be used for all box gutter parts.



Item number	Material	Order number	Color	Packaging
85855	PVC-U	118138	BB - grey	1 PC
85853	PVC-U	118136	BD - brown	1 PC

GUTTER SETS

SETS BOXGUTTERS CARPORT/TERRACE (NW) 83

Box gutter set for carport/terrace roofing up to 8 m

Roof gutter set for garden houses with roof lengths of up to 3.0 m, made of UV-resistant and shockproof PVC for NW 68 box-shaped gutters.

Notes:

Due to technical reasons, all box-shaped gutter components have to be connected using special adhesive no. 81250, included in the set.

Processing instructions: The special adhesive no. 81250 must be used for all box gutter parts.



Item number	Material	Order number	Color	Packaging
85854	PVC-U	118137	BB - grey	1 PC
85852	PVC-U	118135	BD - brown	1 PC

GUTTER SETS

ROOFING SET / DOWNPIPE SET

Box gutter set for garden house up to 2 m

Gutter set specially designed for octagonal garden houses, made of UV and shock-resistant PVC for NW 68 box-shaped gutters.

Notes:
Special adhesive no. 81250 should be used for all box-shaped gutter components.
Processing instructions: The special adhesive no. 81250 must be used for all box gutter parts.



Item number	Material	Length (cm)	Order number	Color	Packaging
85866	PVC-U	202	106387	BC - dark brown	1 PC

Rainwater downpipe set for wintergarden

Downpipe sets for sunrooms made of UV and shock-resistant PVC for DN 50 half-round gutters.

Notes:
200-cm rainwater downpipe including plug socket, 45° pipe elbow, clip pipe clamps, screw sockets.



Item number	Material	Length (cm)	Order number	Color	Packaging
84000	PVC-U	200	104912	BA - white	1 PC
86600	PVC-U	200	105379	BC - dark brown	1 PC
86602	PVC-U	200	110903	91 - anthracite	1 PC

Rainwater downpipe set for wintergarden

Downpipe sets for sunrooms made of UV and shock-resistant PVC for DN 75 half-round gutters.

Notes:
250-cm downpipe including plug socket, 45° pipe elbow, 2 clip pipe clamps, screw sockets.



Item number	Material	Length (cm)	Order number	Color	Packaging
84400	PVC-U	250	104370	BA - white	1 PC
86601	PVC-U	250	105381	BC - dark brown	1 PC
86603	PVC-U	250	110904	91 - anthracite	1 PC

PRODUCT INFORMATION
APPLICATION EXAMPLES



TOOLS

Adhesive for PVC tube

Special dissolving adhesive for the quick and reliable bonding of molded parts made of rigid PVC with good temperature resistance and good UV resistance.

Notes:

Tube 180g

Processing instructions: Transparent and fast-setting.

For bonding gaps < 0.1 mm.



Item number	Material	Length (cm)	Order number	Color	Packaging
81250		19	116916		30 PC

Gutter bracket bending pliers

Bending pliers for gutter brackets



Item number	Material	Length (cm)	Order number	Color	Packaging
81255	Galvanised steel	200	104949	J3 - fir green	1 PC

Gutter repair tape

Repair tape for gluing to half-round and box-shaped gutters.



Item number	Material	Length (cm)	Order number	Color	Packaging
82222	PVC-U	250	106951	90 - black	1 PCS

CONCRETE / SCREED JOINT PROFILES

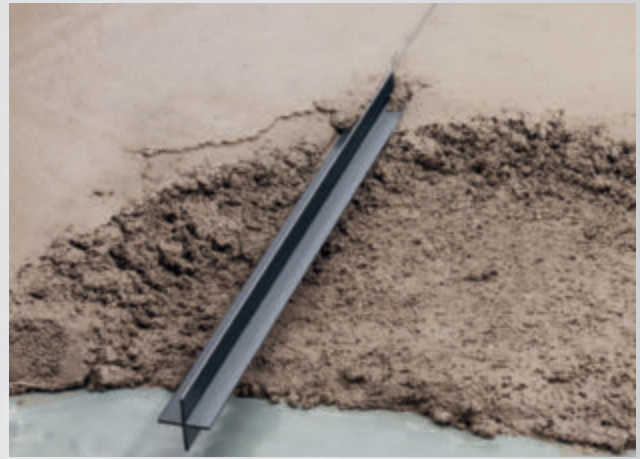
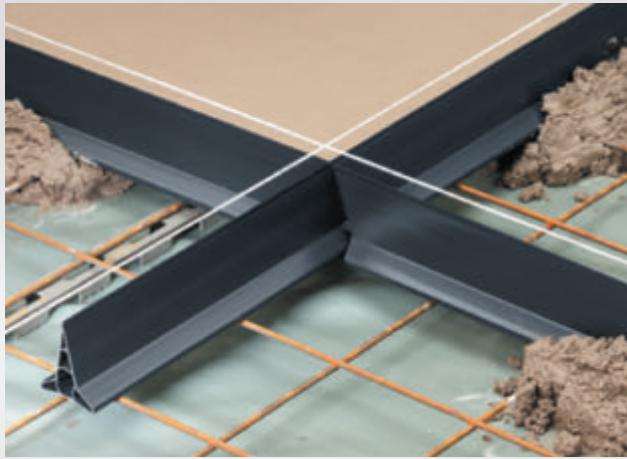

Protektor concrete and screed profiles enable you to perform concrete construction, screed and flooring work with optimum results – because many construction phases can be carried out much more easily and precisely. We achieve this through top quality and a sophisticated range: Protektor concrete and screed profiles are made of materials which

stand out due to their premium quality and user benefits. In this catalogue, you will therefore find a selection of profiles which are perfectly adapted to the most common concrete and screed joints. Other solutions such as the step corner profile and the gravel trap are practical supplements to our range and support you in your daily work.



1. CONSTRUCTION AND PRESS JOINTS

Construction and press joints are construction and press phases which occur during the installation of screed in large areas. The joints are usually filled with solid bond resin.

2. DUMMY JOINTS

Screed, particularly concrete screed, shrinks during drying, which can result in the formation of wild cracks. A dummy joint is a planned and defined crack in the screed (predetermined breaking point).

Timely planned joints in the flooring (e.g. tiles, ceramics, linoleum, etc.) make it possible to form clean and straight dummy joints in the screed with dummy joint profiles. Some dummy joint profiles effectively lock the screed plates in place. Dummy joints in door soffits and passageways should not be sealed or closed. When hammering down the dummy joint profiles, it is important to install them horizontally/ vertically to ensure consistently high overlapping of the sides. Then the sides are covered with screed and smoothed.

In elastic and soft floorings (e. g. linoleum, carpeting, etc.), it is advisable to continue the dummy joint in the flooring with movement joint profiles. Otherwise it is possible that the dummy joints are visible in the flooring. This depends, however, on the quality and properties of the flooring, possible temperature fluctuations and expansion as well as formation and position of the dummy joint. In hard floorings (e.g. stone, ceramics, etc.), the joints must be continued in the flooring.

It is not part of the standard procedure or possible to fill screed with bond resin when dummy joints are already installed. As an alternative, the dummy joint can be made with a trowel groove and then filled with bond resin.

The screed specifications apply correspondingly to concrete floors.

3. MOVEMENT JOINTS

Movement joints separate the screed. They interrupt heat and sound transmission and allow movement. Movement joints must extend to the insulation layer. Possible reinforcements in the screed must be separated. They must be formed with elastic material or a special movement joint profile in the flooring area.

According to DIN 18560-2, movement joints within screed surfaces must be secured against height offset if required. It must be ensured that the screed is dried properly; the use of screed plugs is recommended.

Especially suited solutions or movement joint profiles must be used for movement joints in the screed above building joints.

4. BUILDING JOINTS

Building joints completely separate the building, including base plate, screed and walls. Settlement in the building may also be expected. Building joints can be found in larger buildings, halls and annexes to existing buildings.

5. EDGE JOINTS

Edge joints separate the screed at walls, supports, door reveals, etc. and can be regarded as movement joints. They are usually constructed using edge strips.

NOTES

Please comply with the corresponding guidelines and standards when installing concrete and screed profiles. The concrete and screed profiles are suitable for light to medium loads. This also depends, however, on the employed concrete and screed quality as well as the future use of/loads on the floor and joint. The profiles are not suitable for e. g. heavy equipment, forklifts or dynamic loads. More information on the respective profiles can be found in the product overview.

CONCRETE/SCREED JOINT PROFILES

PRODUCT INFORMATION



OVERVIEW OF MAIN APPLICATIONS

Item number	Description	Material	Screed				Concrete floors, concrete slabs			
			Dummy joints	Movement joints	Edge stop	Drip profile	Dummy joints	Edge stop	Drip profile	
3908	Dummy joint profile for concrete floors	Rigid PVC					X	X	X	
3906	Dummy joint profile for screed	Rigid PVC	X			X				
1116	Dummy joint profile for screed	Galvanised steel	X							
3914	Dummy joint profile for screed	Rigid PVC	X							
3915	Dummy joint profile for screed	Rigid PVC	X							
3917	Dummy joint profile for screed and concrete floors	Rigid PVC with foam pad	X				X			
3929	Movement joint profile for screed	Rigid PVC with PE foam		X						
3923	Movement joint profile for screed	Galvanised sheet steel with PE foam and steel plugs with polymer coating		X						
3916	Movement joint profile for screed	Galvanised sheet steel with PE foam and steel plugs with polymer coating		X						

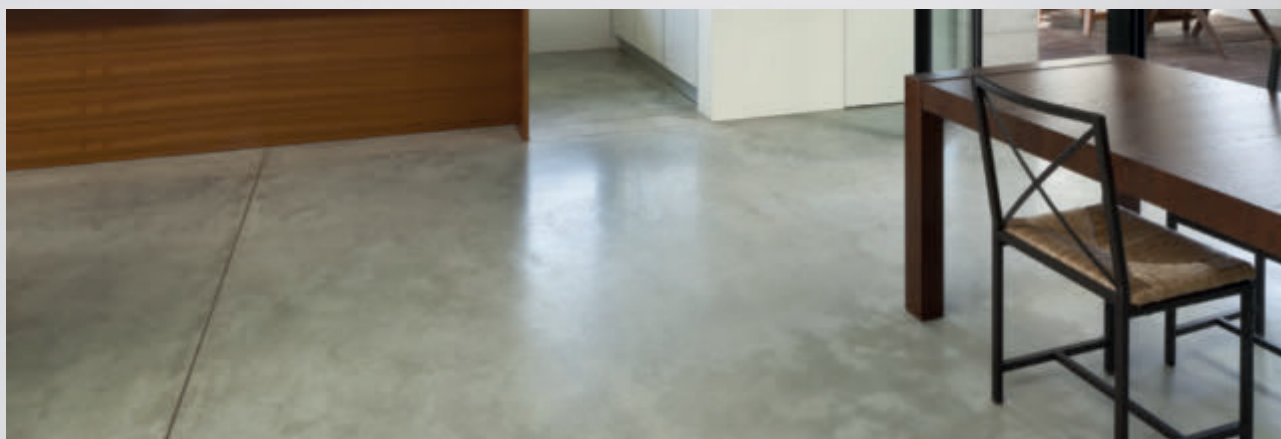

JOINT PROFILES

Dummy joint profile concrete PVC

PVC dummy joint profiles for concrete floors is used to create clean and straight dummy joints as well as drip profiles and formwork stops. The channel in the profile can also be used to route cables. The profile's wide contact area ensures a high degree of stability.

Function:

- dummy joint
- drip profile
- formwork stop
- channel for cable routing
- straight joint run

Height (b): 80 mm

Processing instructions: Installation is carried out before concrete pouring and set on concrete chunks spaced approx. 70-80 cm from one another. Level the profile to the desired height. The concrete loss creates a joint of 1-2 mm along the profile. The position and distance of the profile depends on the specifications from the planner.

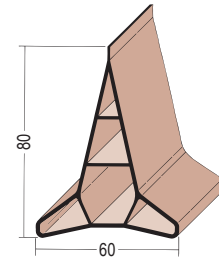

Item number	Material	Length (cm)	Order number	Package/ Large pack
3908	PVC-U	500	102504	5 PCS / 48 BUN

Dummy joint profile screed PVC

Screed dummy joint profile for screed for creating clean and straight dummy joints as well as drip profiles.

Function:

- dummy joint
- drip profile
- straight joint run.

Height (b): 40 mm

Processing instructions: Installation is carried out when the screed is being laid and is simply placed into the freshly set screed. Level the profile to the desired height. The concrete loss creates a joint of 1-2 mm along the profile. The position and distance of the profile depends on the specifications from the planner.

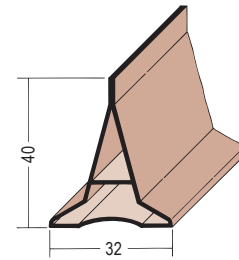

Item number	Material	Length (cm)	Order number	Package/ Large pack
3906	PVC-U	300	102502	10 PCS / 80 BUN

Dummy joint profile screed galvanised steel

Screed dummy joint profile for screed for creating clean and straight dummy joints. Helps to lock screed panels.

Function:

- dummy joint
- straight joint run
- clean surface finish

Height (b): 30 mm

Processing instructions: Installation takes place while the screed is being laid. Level the profile to the desired height. When pushing in the profile, remember to horizontally/vertically orient the profile as to ensure that the leg overlap is equally high. The closed side must be installed so it faces up.

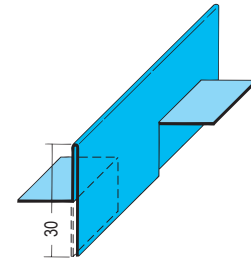

Item number	Material	Length (cm)	Order number	Package/ Large pack
1116	Galvanised steel	200	100001	15 PCS / 48 BUN

Dummy joint profile screed PVC

Screed dummy joint profile for screed for creating clean and straight dummy joints.

Function:

- dummy joint
- clean surface finish
- straight joint run

Height (b): 25 mm

Processing instructions: Installation takes place while the screed is being laid. When pushing in the profile, remember to horizontally/vertically orient the profile to ensure that the leg overlap is equally high. The higher leg must be installed vertically.

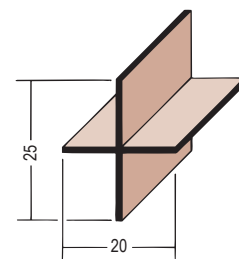

Item number	Material	Length (cm)	Order number	Package/ Large pack
3914	PVC-U	250	102563	40 PCS / 24 BOX

JOINT PROFILES

Dummy joint profile screed PVC

Screed dummy joint profile for screed for creating clean and straight dummy joints.

Function:

- dummy joint
- clean surface finish
- straight joint run

Height (b): 35 mm

Processing instructions: Installation takes place while the screed is being laid. When pushing in the profile, remember to horizontally/vertically orient the profile to ensure that the leg overlap is equally high. The higher leg must be installed vertically.

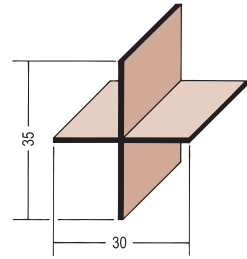

Item number	Material	Length (cm)	Order number	Package/ Large pack
3915	PVC-U	250	102571	40 PCS / 20 BOX

Dummy joint profile screed/concrete PVC

Dummy joint profile for concrete floors and screed for creating clean and straight joint profiles. This profile, made of PVC and a neoprene insert with pre-stress, is resistant against most media, such as oils, fats, etc.

Function:

- dummy joint
- joint sealant
- straight joint run

Height (b): 30 mm

Processing instructions: Installation while conducting concrete work or screed installation:
Set the profile into the fresh concrete or screed and level to the desired height.
Installation in the trimmed joint for creating a sealed joint through pre-stress:
The profile is to be pressed into the trimmed joint. The pre-stress of the profile allows for the joint to be sealed. The joint cut should be approx. 6-7 mm wide and approx. 32 mm deep.

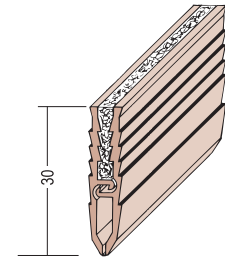

Item number	Material	Length (cm)	Order number	Package/ Large pack
3917	PVC-U + Cellular rubber	250	102583	40 PCS / 24 BOX

Movement joint profile PVC

Movement joint profiles with asymmetric shapes for creating clean and decoupled connections to other construction components.

Function:

- asymmetric movement joint profile, for simple as well as double installation
- clean connections to other construction elements offered by the asymmetric shape
- universal applications for various screed heights
- secure de-coupling
- simple installation

Height (b): 95 mm

Processing instructions: The movement joint profile is characterised by its asymmetric shape. The 95-mm-high PE strip is elastic yet retains its shape relatively well. This allows for the universal application of just a single movement joint profile for various screed heights. This reduces the need for warehousing. Double installation is also possible with the asymmetric movement joint profile, ensuring greater screed movement absorption. The asymmetric shape provides for clean and decoupled connections to other construction elements.

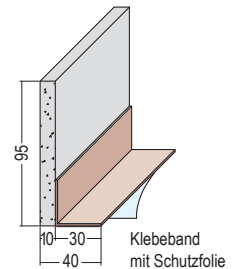

Item number	Material	Length (cm)	Order number	Package/ Large pack
3929	Hard PVC + PE strips	250	110945	12 PCS / 12 BOX

JOINT PROFILES

Movement joint profile

Movement joint profiles for creating movement joints using shear force dowel fastening.

Function:

- movement joints
- especially well-suited for floating screed
- straight joint run
- clean surface finishes
- shear force dowel fastening
- height offset

Processing instructions: Installation takes place before the screed is laid. The profile is laid in accordance with the prescribed joint plan and may be sealed using the adhesive tape. The dowels are installed horizontally, at a right angle in relation to the joint. The distance between the dowels is approx. 30 cm. Once the screed has dried, cut off the protruding foam material strips flush along the screed surface (see installation example, similar to 3916).

Notes:

54 screed dowels nr. 3940 are enclosed in the packaging.

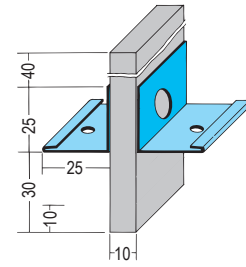

Item number	Material	Length (cm)	Order number	Package/ Large pack
3923	Galvanised steel + PE foam	250	102604	6 PCS / 25 BOX

Movement joint profile

Movement joint profiles in screed for creating movement joints using shear force dowel fastening.

Function:

- movement joints
- especially well-suited for floating screed
- straight joint run
- clean surface finishes
- shear force dowel fastening
- height offset

Processing instructions: Installation takes place before the screed is laid. Place profile in line with the prescribed joint plan. Install the dowels horizontally at a right angle in relation to the joint at a distance of 30 cm (see installation example)

Notes:

90 screed dowels nr. 3940 are enclosed in the packaging.

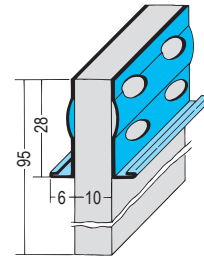

Item number	Material	Length (cm)	Order number	Package/ Large pack
3916	Galvanised steel + PE foam	250	102576	10 PCS / 20 BOX

Screed peg PVC

Screed dowels provide shear force dowel fastening in screed and reduce possible height offset.

Notes:

Screed dowels are also delivered from the factory in the corresponding amounts for movement joint profiles no. 3916 and 3923.

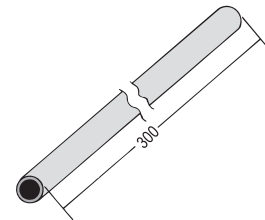

Item number	Material	Length (cm)	Order number	Package/ Large pack
3940	Galvanised steel, with PVC coating	30	102636	100 PC / 40 BOX

CONCRETE/SCREED JOINT PROFILES

PROCESSING EXAMPLE FOR MOVEMENT JOINT PROFILE 3916



Trim the PE foam strip along the lower edge to the required height, according to the screed thickness. Mark and cut using an all-purpose blade.



Mark the openings for the heating pipes exactly. When the profile is used between door frames, cut it to length so that it can be easily clamped between the edge strips.

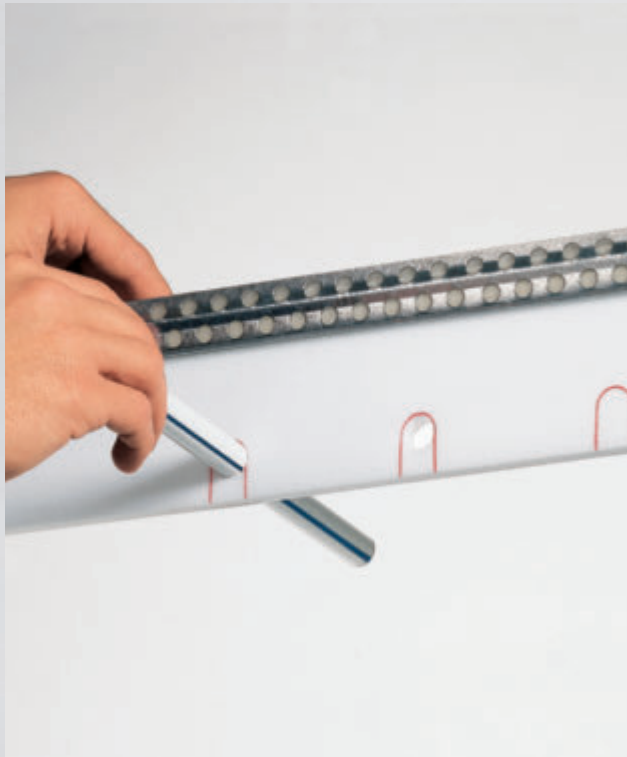

Exact pipe openings can be produced by puncturing the foam strip with a piece of pipe. Then cut through the foam strip with a straight cut downwards.



Place over the installed heating pipes and fix using dabs of mortar. Insert the plugs approx. 30 cm apart directly below the metal rail.

HEAT CONDUCTION PLATES

Heat conduction plate

Heat conducting panels for ensuring even and effective floor warming.

Product width: 118 mm

Processing instructions: Place the heat conducting panels in the system panel and install the heating pipes in the grooves.

Ideally suited for dry screed, cement screed and floating screed.

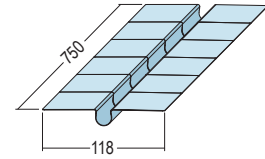

Item number	Material	Length (cm)	Order number	Package/ Large pack
50414	Galvanised steel	75	110787	50 PC / 27 BOX
50914	Aluminum	75	116049	50 PC / 27 BOX

Heat conduction plate

Heat conducting panels for ensuring even and effective floor warming.

Product width: 120 mm

Processing instructions: Place the heat conducting panels in the system panel and install the heating pipes in the grooves.

Ideally suited for dry screed, cement screed and floating screed.

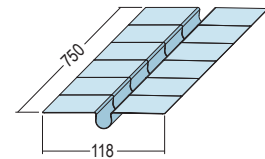

Item number	Material	Length (cm)	Order number	Package/ Large pack
50416	Galvanised steel	75	115774	48 PC / 27 BOX
50916	Aluminum	75	115773	48 PC / 27 BOX

CONCRETE/SCREED JOINT PROFILES

STAIR CORNER PROFILE



SAFETY AT EVERY STEP



Staircases always pose some risk for accidents. The proper precautions must be taken, especially in public buildings. The PROTEKTOR stair corner profile is ideally suited for guaranteeing safety while offering visually attractive accents and a modern design. The anti-slip profiling on top of the profile reduces the risk of slipping when using the stairs. At the same time, the profile also protects delicate stair edges against damage and increased wear. It is also well suited for use when conducting repair work.

Tests:

- ▶ Verification of slip resistance in accordance with DIN 51130 and data sheet BGR 181. Test results: R 10
- ▶ Verification of the displacement volume in accordance with DIN 51130 and data sheet BGR 181. Evaluation group for the displacement space: V 8

Application:

- ▶ Pre-fabricated stair components
- ▶ New stair constructions (in-situ concrete)
- ▶ Repair rails
- ▶ For interior and exterior areas (V2A, 1.4301)

PROTEKTOR TREPPENKANTEN-PROFIL
SICHERHEIT AUF SCHRITT UND TRITT

Treppen bergen stets eine gewisse Unfallgefahr. Gerade in öffentlichen Gebäuden gibt es hier entsprechende Bestimmungen zu treffen. Das PROTEKTOR Treppenkanten-Profil kommt dann zum Einsatz, wenn es darum geht, Sicherheit des einen Schritt anstreichen können und wieder zum Design zu verbinden. Durch seine charakteristische Rutschprofilierung verringert es das Rutschgefahr beim Betreten der Stufen. Im gleichen Zug wird die empfindliche Treppenkante vor Beschädigung und Verschleißschädigung geschützt. Das Profil kann ebenfalls im Falle einer Reparatur verwendet werden.

Einsatz:

- Treppen-Fertigteilbau
- Treppen-Neubau (Ortbeton)
- Reparaturschiene
- Für den Innen- und Außenbereich (V2A, 1.4301)

Prüfungen:

- Prüfung der Rutschbestimmung gemäß DIN 51130 und Merkblatt BGR 181. Ergebnis der Prüfung: R 10
- Bestimmung des Verdrängungsraumes gemäß DIN 51130 und Merkblatt BGR 181. Bewertungsgruppe für den Verdrängungsraum: V 8

Art-Nr.	Material	Standard	Abmessung	Preis pro m
1000	2000	2000	2000	2000

PROTEKTOR PRODUKTE DER INNOVATIONEN



STAIR CORNER PROFILES

Step corner profile Stainless steel

Stainless steel stair strips with a matt surface and non-slip protection,

Notes:
Specially developed for schools and kindergartens. Satisfies the german guidelines and requirements of the statutory accident prevention regulations. See technical information.

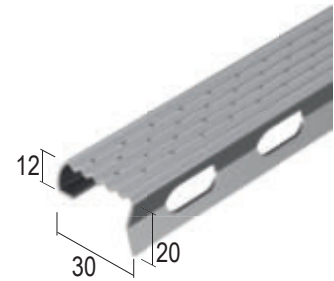

Item number	Plaster thickness (mm)	Length (cm)	Order number	Material	Package/ Large pack
2000		100	101133	Stainless steel	25 PCS / 56 BOX
		110	105691	Stainless steel	25 PCS / 56 BOX
		120	101138	Stainless steel	25 PCS / 56 BOX
		130	101140	Stainless steel	25 PCS / 28 BOX
		150	101142	Stainless steel	25 PCS / 28 BOX
2001		500	101146	Stainless steel	12 PCS / 80 BUN

SPECIAL PROFILE GRAVEL TRAP STRIP

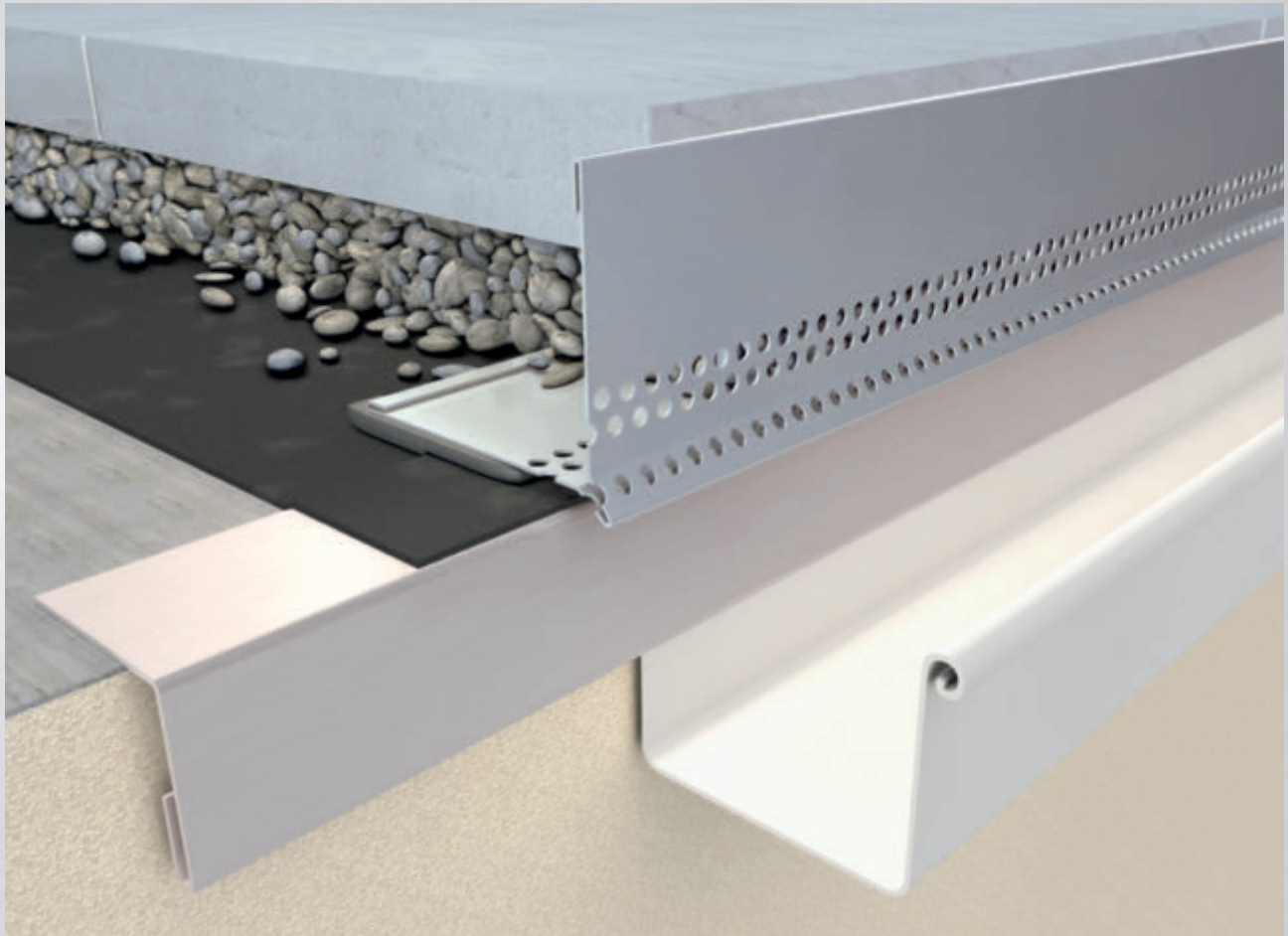

INSTRUCTIONS FOR APPLICATION

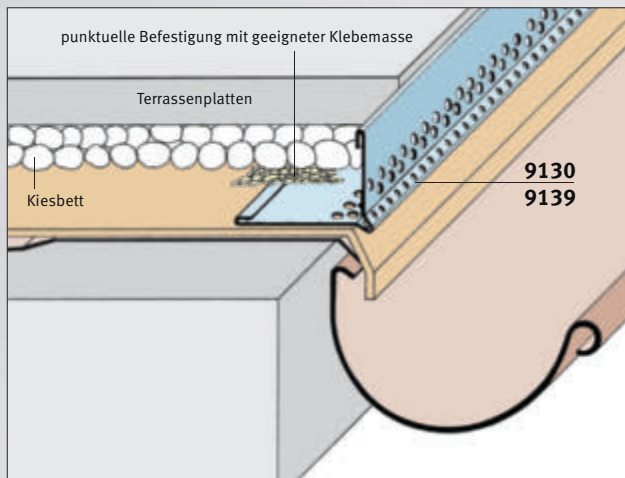

The gravel trap strip is ideally suited for loosely laid large balcony and terrace plates. Use suitable adhesive cement for securing gravel trap strip point by point. A suitable, load-bearing surface and superstructure must be installed as a substrate for the balcony and terrace plates. Suitable gravel/grit is to be appropriately compressed. The gravel trap strip is not to be strained by loads or movement caused by the balcony and terrace plates.

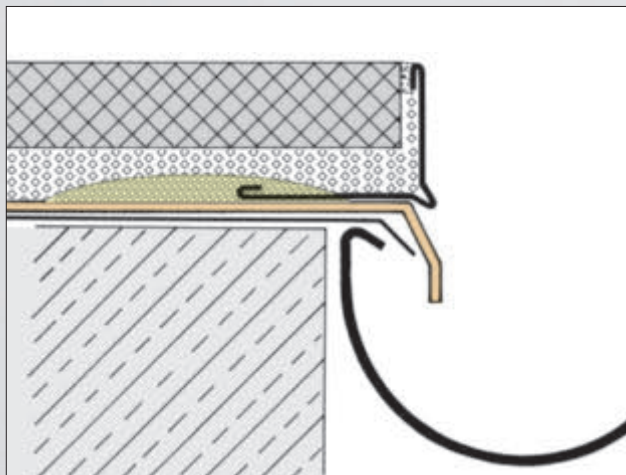

Our product flyer “Gravel trap strips” can be found at www.protektor.de



GRAVEL TRAP STRIPS

Gravel trap Alu

Water-permeable gravel trap strips with a drip edge, available for heights of 50 and 70 mm.

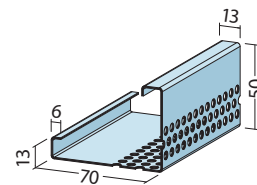

Item number	Material	Length (cm)	Order number	Package/ Large pack
9361	Aluminum natural	250	112154	10 PCS / 20 BUN

Gravel trap Alu

Water-permeable gravel trap strips with a dripping edge (both legs perforated), available for heights of 80 and 100 mm.

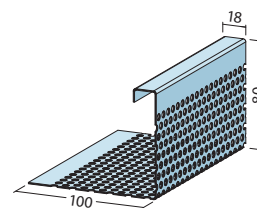

Item number	Material	Length (cm)	Order number	Package/ Large pack
9424	Aluminum natural	250	111785	10 PCS / 24 BUN

Gravel trap Alu

Water-permeable gravel strip with a dripping edge, available in heights of 80 mm.

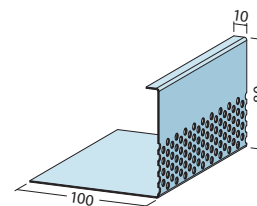

Item number	Material	Length (cm)	Order number	Package/ Large pack
9423	Aluminum natural	250	106684	10 PCS / 30 BUN

Gravel trap Alu

Water-permeable gravel trap strips with a drip edge, available for heights of 80 and 90 mm.

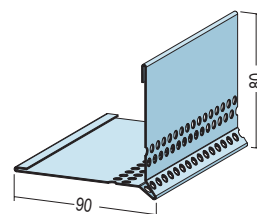

Item number	Material	Length (cm)	Order number	Package/ Large pack
9130	Aluminum natural	250	105761	10 PCS / 30 BUN

Gravel trap Alu

Water-permeable gravel trap strips with a drip edge, available for heights of 50 and 70 mm.

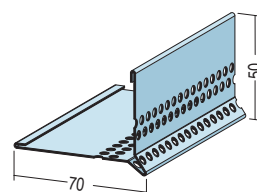

Item number	Material	Length (cm)	Order number	Package/ Large pack
9139	Aluminum natural	250	104199	10 PCS / 49 BUN

GRAVEL TRAP STRIPS

Edge stop profile Alu

Edge stop profile 100 x 120 mm

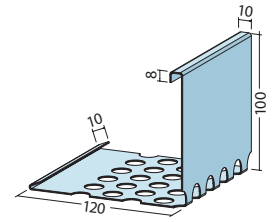

Item number	Material	Length (cm)	Order number	Package/ Large pack
9421	Aluminum natural	250	103846	6 PCS / 20 BUN

PLASTER PROFILES

1. Materials

- Galvanized slit strip or sheet steel with a zinc coating code Z275 or Z350 (increased zinc coating) to DIN EN 10143 and DIN EN 10346. Also with organic coating to DIN EN 10169-1.
- Aluminium strips and sheets in special alloys, possibly with acrylic, PUR or polyester coating according to DIN EN 485 and DIN 573.
- Stainless steel slit strip according to EN 10088, material no. 1.4301.
- Galvanized steel wire according to DIN EN 10218-1, DIN EN 10244-1 and DIN EN 10244-2 (min. class A).
- Stainless steel wire according to DIN EN 10264-4.
- Rigid PVC impact resistant according to DIN EN 21306 .
- Soft PVC in suitable Shore hardness. Special qualities in synthetic rubber compound. Both materials are resistant to weathering and ageing according.

2. Guarantee

- The company guarantees within its general terms of business the excellent quality of raw material used according to the above mentioned indications as well as the efficient manufacture of products.
- As the composition and the chemical and physical properties of the plasters used are outside the company's influence, no guarantee can be given for the resistance of the profiles to corrosion. In cases where new plastering and insulating materials are used, the buyer is advised to determine whether they are compatible with the profile material.
- Varying factors in the application of plaster make it necessary to adapt to the individual working conditions from case to case. This is the responsibility of the buyer. The term of guarantee for plaster profiles is twelve months, in compliance with the legal regulations on sales contracts, and begins on the date of delivery.
- Practical tests are the safest way to avoid possible mistakes, for which no guarantee can be given. Corrosion can only occur if the plasters are under permanent influence of humidity or if they dry too slowly. Make sure the plaster dries quickly by airing well.

3. Production Methods

- Rolling on profiling machines (with safety devices to prevent damage to the material surface). Pressing and punching. Extruding of PVC.

4. Packing

We are member of Interseroh, contract no. 25 608

- Metal profiles are packed in paper and secured with wire or foil.
- PVC profiles are packed in cartons or in foil.
- For long lengths, wooden laths provide additional protection.
- Each bundle is marked with the type and number of PROTEKTOR profile, length, units per bundle and colour.

5. Delivery and Transport

- Fast delivery is made possible by sufficient stocking and production capacity. Large quantities are transported on special pallets by our own forwarding agents. We have stockists in Germany and further stockists in Europe and Middle East.

6. Technical Service

- Samples, catalogues and special literature is available with detailed information. A detailed technical showroom at our offices. Lectures to distributors, guilds and training schools. Participation in Building Exhibitions in Germany and abroad.

7. Advice to Follow

Protektor plaster profiles are used as plaster support according to DIN EN 13914 and DIN EN 13658.

- The plaster thickness shown in the drawings are the minimum thickness to be realized with a tolerance of +/- 1 mm without fixing material. The minimum thickness is to be controlled at the fixing of the profile and in case of differences to be claimed immediately. Claims after the finishing of the plaster work can not be accepted.
- Choose your profiles to suit their application (inside or outside) and the plaster thickness to be used. Choose practical lengths, e.g. to suit storey height and door size. Profiles can be cut into short lengths for window and radiator recesses.
- Cut the metal profiles with hand plate shears only, do not use a parting-off grinder (there is a danger of damage to the galvanising or coating). Profiles should be used as long lengths as possible for corners and base-edging outdoors.
- PROTEKTOR profiles fixed once allow continuous application of the plaster and removal of clean surfaces over exact edges. This eliminates the need to batten slats. Profiles near the ground may be particularly at risk of snow accumulation, road salt contamination or heavy splashing water. Therefore, only suitable profiles should be used there in accordance with the instructions for the individual materials. We recommend the use of stainless steel profiles for very exposed locations and facades exposed to strong weather conditions. The edges of the stainless steel profiles must not be stripped with normal steel tools - risk of extraneous rust! (see also point 9)
- Expansion joints/sliding bearing joints: Expansion joints (vertical) and sliding bearing joints (horizontal) are structurally necessary joints that separate all components of a building across the joint width and must be adopted in the respective finishing trades (plaster and ETICS). They must be dimensioned, planned and executed in accordance with the relevant valid regulations. Expansion joint profiles and sliding bearing joint profiles (or profile combinations) cover these joints and absorb tensile and compressive movement. The specifications for maximum movement absorption (tension/pressure) according to the information in the product catalogue or product data sheet must be observed .

Examples of expansion joints:

Transition from old building to new building or for terraced houses.

Examples for sliding joints:

Elevations, slab sliding bearings, parapet formations, often in connection with material changes in the wall former.

Movement joints (also construction joints or field boundary joints):

Movement joints are separation joints with small movements, especially from the plaster system or cladding. Movement profiles have a centre piece made of flexible plastic to absorb the small movements. Their use is only permitted for vertical joints. Alternatively, profile combinations of end profiles with joint sealants can be used.

Examples of movement joints: Field boundaries in plaster systems for large surfaces, absorption of minor changes in position in wall

PLASTER PROFILES

or ceiling coverings, brick lining of steel, reinforced concrete and timber frame components.

8. Installing the Profiles

- ▶ With plaster and anhydrite mortars containing gypsum, the profiles can be applied with the same material. In damp rooms and in the case of surfaces where cement – lime cement, plaster and wall binding agents – are to be applied, materials containing gypsum should not be used for fixing the profiles. The same applies for external rendering. In such cases, fixing mortar on a cement base should be used. Should galvanised nails be used for fixing the profiles, they should be removed before the plaster is applied.

9. Compatibility

- ▶ Check the compatibility between plaster mortar and profile material. (See leaflet for planning and application of plaster profiles for exterior and interior use).
- ▶ Profiles made of galvanised sheet steel are suitable for mineral plasters based on lime, lime cement, PM binder, cement or gypsum.
- ▶ Aluminium profiles are suitable for gypsum, synthetic resin plasters or fillers in interior areas.
- ▶ Aluminium profiles with white primer coating are suitable for plasters based on lime, lime cement, PM binder, cement or gypsum. Also available with top coating/finishing coats of synthetic resin/silicate resin and silicate plasters. Indoors also for wall surfaces in kitchens and bathrooms with the water exposure classes WO-I (low water exposure), W1-I (moderate water exposure) and W2-I (high water exposure) according to DIN 18534-1.
- ▶ Plaster profiles made of stainless steel, material no. 1.4301, are suitable for
 - for all types of plaster and mortar
 - for indoor and outdoor use;
 - for thermal insulation;
 - Indoors for use in kitchens and bathrooms, windowless rooms with forced ventilation, shafts, indoor swimming pools/brine pools with all water exposure classes WO-I to W3-I (very high water exposure) in areas where the profiles are covered by plaster, tiles or paint (exposed profiles require special care, see also point 10);
 - In outdoor areas also for plinth surfaces with influences such as snow accumulations, road salt contamination or heavy splashing water contamination.
 - where the effects of moisture must be expected over time;
 - where optimum corrosion protection is required due to special conditions in the building structure and its surroundings.
- ▶ All stainless steel profiles in this catalogue are made of material 1.4301.

10. Cleaning and care of uncovered surfaces, e.g. of profiles for ceramic tiles and heavy corner beads made of stainless steel after fixing

- ▶ The high resistance of PROTEKTOR stainless steel profiles is only guaranteed if the surface is unblemished.
- ▶ The surface is plain, hard and non-porous. You can use customary cleaning material, but should rinse thoroughly with clear water after cleaning
- ▶ Basic cleaning: At external construction elements it is absolutely necessary to remove protection coating immediately after fixing. Atmosphere influences can lead to aging of the coating making removal difficult or impossible. This can also lead to separation of chloride and formation of hydrochloric acid. Since invisible traces of adhesives or protection lacquers can lead to corrosion, cleaning with basic cleaner is always necessary. In case of first cleaning, lime and cement splashes should be removed with a rubber scraper, a wood ship or similar – if possible before setting. Do not use tools made of normal steel (spattle, steel wool), since they can cause extraneous rust. Hydrochloric acid should not be put on the surface – even as weak solution (e.g. acid treatment from adjacent brickwork or ceramic construction elements). If tiling cannot be done without acid treatment you should wash thoroughly with clear water immediately (use high-pressure cleaner).
- ▶ Maintenance: How often you should clean depends on intensity and type of dirt as well as on demands you make on the visual quality of the stainless steel construction elements. Particular attention should be paid to possible dirt traps. If using usual cleaning material the instructions for use should be strictly observed.

© PROTEKTORWERK

TECHNICAL INFORMATION

ROUND EDGES FOR ENHANCED SAFETY



The safety of children and elderly people in public buildings has been a topic of statutory accident insurance for many years. New modern architectural design and the development of innovative coating materials led to the „Guidelines for Kindergarten Construction and Equipment“, in force since October 1992, being revised and updated at the beginning of 2006. Currently, the accident prevention regulations for day care facilities for children (DGUV regulation 82, previously GUV-VS2) apply.

In April 2009, the German Social Accident Insurance (DGUV) also published the BG/GUV-SR S2 rule „Kindertageseinrichtungen“ („Child Day Care Facilities“). This has since been transferred to DGUV Rule 102-002.

According to §9 of DGUV Regulation 82, walls and columns must be designed in such a way that the risk of injury from sharp edges and pointed rough surfaces is avoided.

Stair treads must be easily recognisable in accordance with §12, (2) and must not be sharp-edged. These requirements are specified in the DGUV regulation 102-002 as follows:

- For walls and columns up to a height of 2.00 m, the following designs, among others, are recommended in order to avoid the risk of injury:
 - Rounding radius ≥ 2 mm
 - broken or chamfered edges
(corresponding to the radius of curvature ≥ 2 mm)

- rounded corner plaster rails
- The following designs are recommended for stair treads in order to avoid the risk of injury:
 - Rounding radius ≥ 2 mm
 - broken or chamfered edges
(corresponding to the radius of curvature ≥ 2 mm)

PROTEKTOR considers these requirements when modifying existing and developing new profiles. As a result, a dedicated product range for forming edges has evolved over time. Solutions for forming edges that comply with the required safety aspects can be found among the numerous profiles. This applies not only to projects that are subject to these regulations, of course, but for any buildings where particular importance is placed on accident protection and on minimizing the risk of injury from edges.

PROTEKTOR information: Profiles described in PROTEKTOR literature as having a radius $r = 2$ mm or diameter $d = 4$ mm should not be used for kindergartens and schools as manufacturing tolerances may result in the actual dimensions being marginally smaller.

Accordingly, all profiles with radius/diameter $r \geq 2.5$ mm / $d \geq 5$ mm are particularly suited.

PARTICULARLY SUITABLE PLASTER PROFILES FOR INDOOR USE

Item-Nr.	Plaster thickness (mm)	Length (cm)	Material	Remark
1015	8	240, 250, 300	Galvanized steel	$r = 4,75$ mm / $d = 9,5$ mm
1005	10	200, 250, 260, 300	Galvanized steel	$r = 3,75$ mm / $d = 7,5$ mm
1160	15	295	Galvanized steel	$r = 20$ mm / $d = 40$ mm, Profile edge can be fully covered with plaster
1041	12	250	Galvanized steel ²⁾	$r = 4$ mm / $d = 8$ mm, flexible, for arches, etc.
7426	20	300	Galvanized steel	$r = 2,5$ mm / $d = 5$ mm
9571	10	260	Aluminium white ¹⁾	$r = 12,5$ mm! / $d = 17,5$ mm! Profile edge cannot be covered with plaster
2041	-	200, 250	Stainless steel ³⁾	$r = 3,5$ mm / $d = 7$ mm, for retrofitting
2066	-	250	Stainless steel ³⁾	$r = 3,5$ mm / $d = 7$ mm, for retrofitting
2215	8	260	Stainless steel	$r = 4,75$ mm / $d = 9,5$ mm
7476	10	300	Stainless steel	$r = 2,5$ mm / $d = 5$ mm
2026	16 incl. anchor)	200, 250, 300	Stainless steel ³⁾	$r = 4$ mm / $d = 8$ mm, plus sliding anchor 2072
7478	15	250, 300	Stainless steel	$r = 2,5$ mm / $d = 5$ mm
7483	20	300	Stainless steel	$r = 2,5$ mm / $d = 5$ mm
2027	21 incl. anchor)	200, 250, 300	Stainless steel ³⁾	$r = 10$ mm / $d = 20$ mm, plus sliding anchor 2073

PARTICULARLY SUITABLE PLASTER PROFILES FOR OUTDOOR USE

Art.-Nr.	Putzdicke (mm)	Längen (cm)	Werkstoff	Bemerkung
1013	14	200,225,250,260,275,300	Galvanized steel ²⁾	$r = 4$ mm / $d = 8$ mm
1014	20	250, 300	Galvanized steel ²⁾	$r = 4,25$ mm / $d = 8,5$ mm
1020	10	225, 250, 300	Galvanized steel ²⁾	$r = 4,25$ mm / $d = 8,5$ mm
1028	15	250, 300	Galvanized steel ²⁾	$r = 3,5$ mm / $d = 7$ mm
1041	12	250	Galvanized steel ²⁾	$r = 4$ mm / $d = 8$ mm, flexible, for arches, etc.
1086	12	300	Galvanized steel ²⁾	$r = 4$ mm / $d = 8$ mm, Profile edge can be fully covered with plaster
11601	15	295	Galvanized steel	$r = 13$ mm / $d = 26$ mm, Profile edge cannot be covered with plaster

PARTICULARLY SUITABLE PLASTER PROFILES FOR DRYWALL USE

Item-Nr.	Plaster thickness (mm)	Length (cm)	Material	Remark
3763	-	305	PVC white	$r = 2,5$ mm / $d = 5$ mm
3767	-	300	PVC white	$r = 2,5$ mm / $d = 5$ mm, flexible, for arches, etc.
3776	-	305	PVC white	$r = 17$ mm / $d = 34$ mm
3778	-	305	PVC white	$r = 17$ mm / $d = 34$ mm
3780	-	305	PVC white	$r = 23,5$ mm / $d = 47$ mm, Internal corner profile
9172	1	250, 300	Aluminium	$r = 2,75$ mm / $d = 5,5$ mm, profile for forming 135° edges

PARTICULARLY SUITABLE PROFILES FOR STAIRS AND STEPS

Item-Nr.	Plaster thickness (mm)	Length (cm)	Material	Remark
2000	-	100, 110, 120, 130, 150	Stainless steel	Nonslip class R 10
2001	-	500 + extended lengths	Stainless steel	Nonslip class R 10

¹⁾ Basic coating white; ²⁾ Coating: Rigid PVC, colour no. 10 = white; ³⁾ With protection foil (after finishing of plaster work pull off)

DRY WALL/LIGHTWEIGHT STEEL CONSTRUCTION

- (1) Profiles and other stamped items (if labelled) are manufactured on the basis of current national and/or international standards. Other tolerance levels are only valid if agreed in writing.
- (2) We reserve the right to make our profiles and stamped items from other materials whose characteristics at least meet the requirements of the standards.
- (3) All profiles and stamped items are for use in normal, temperature regulated, indoor areas, as defined by DIN EN 13964 tables 7 & 8 class B, or by DIN 18168 table 2 row 1.
- (4) All the constructions mentioned in our catalogue must be installed according to our fitting instructions and test certificates. These are constructed in line with the requirements of the DIN standards they refer to. In addition, when fitting, the manufacturer's instructions must be followed for other materials which we have not supplied. A warranty can only be given if all construction elements are purchased from PROTEKTOR (insofar as we can supply them).
- (5) We assume no liability for the stability of custom designs supplied according to customer requirements.
- (6) We only manufacture special profiles or special accessories according to customer requirements subject to exclusion of liability with regards to protected rights of third parties.
- (7) Any returns of fixed length orders, special profile and special accessory orders are excluded. For special parts, we reserve the right to deliver excess or short quantities of +/-10 %.
- (8) For powder coated parts, order the total required quantity to prevent differences in coating appearance. There is no guarantee that the coating in repeat orders will appear exactly the same. Returns are not accepted.
- (9) Special products, and products with special coatings requested by customers can only be manufactured on the basis of a written order and confirmation, and after supply of the necessary drawings and material specifications in writing.
- (10) No information and illustrations in our documents are binding. This also applies to any verbal explanations we may provide, unless they are confirmed in writing. Printing errors may occur.
- (11) We reserve the right to make changes to products or changes to the type or standard of packaging without notice.
- (12) Publication of this catalogue makes all earlier versions invalid.
- (13) This product information forms part of our terms and conditions of sale.
- (14) Product illustrations may differ from the product delivered.

**PROTEKTORWERK
Florenz Maisch GmbH & Co. KG**

We accept no liability for any printing errors or other changes. Subject to change. Previous catalogues are hereby rendered invalid.

Section 1 General • Scope

- (1) Our terms of sale shall apply exclusively. We shall not acknowledge adverse conditions or a customer's sales terms if they deviate from ours unless we have approved their validity in writing.
- (2) Any agreements made between us and the customer regarding the fulfilment of the contract shall be made in writing in this contract. The product information in the individual catalogues shall also apply.
- (3) Our terms of sale shall apply only to companies in accordance with Section 310 Paragraph 1 of the German Civil Code.
- (4) We are committed to the highest integrity, transparency and ethics in all business activities and relationships. Our current Code of Conduct [<https://www.protektor.de/en/company-profile/code-of-conduct/>] is decisive for this. We apply the same standards to our suppliers.

Section 2 Quotation • Quotation documents

- (1) If the order is to be considered a quotation according to Section 145 of the German Civil Code, we shall accept this within two weeks by means of a written order confirmation.
- (2) The minimum order value shall be 30.00 EUR. For orders under 100.00 EUR, we shall charge a small volume purchase fee of 16.00 EUR.
- (3) Special lengths are possible for plaster and facade profiles under the following conditions: Flat surcharge for set-up costs of 75.00 EUR, minimum purchase of 10 bundles, delivery time on request.
- (4) Orders of single profiles (less than a standard package) are possible for a small range of products. The list of products is available on request. For every opened standard package, we shall charge a packaging surcharge of 10.00 EUR. For plastic profiles in custom colors (minimum order quantity 100 kg) we shall charge a color surcharge of 30 %.
- (5) Dry wall profiles shall always be delivered in full packaging units - PU - only (e.g. package, carton).
- (6) Images and drawings as well as information about weights, quantities or dimensions shall generally be considered only approximate values unless they are labelled as binding in particular individual cases.
- (7) We reserve property rights and copyrights for images, drawings, calculations, and other documents. This shall also be applied to documents received in writing that are labelled „confidential“. The customer shall obtain our written permission before distribution to third parties.
- (8) Models and tools manufactured by order of the customer shall remain our property even if the customer has paid for them in part or in full.

Section 3 Prices • Payment terms

- (1) Unless indicated differently in the order confirmation, our prices shall be „ex works“.
- (2) Our prices do not include value-added tax. The applicable value-added tax shall be indicated as a separate item on the invoice at the time of billing.
- (3) Unless indicated differently in the order confirmation, the purchase price shall be due net (without deduction) within 30 days from the date of invoice. For payment within 14 days, we shall grant a 2 % discount. The legal regulations shall apply pertaining to the consequences of default in payment.
- (4) A customer shall be entitled to offset if his counterclaim has been legally established, undisputed or acknowledged by us. He shall, furthermore, be entitled to exercise a right of retention insofar as his counterclaim is based on the same contractual relationship.

Section 4 Delivery time

- (1) The delivery time indicated by us shall be based on the assumption that all technical questions have been cleared in advanced and may be exceeded by up to two weeks (or up to three weeks for custom orders) unless an explicit agreement for a fixed date has been made.
- (2) Compliance with our delivery obligation is conditional upon the intime and due and proper fulfilment of the customer's obligations. We reserve the right to defend against non-fulfilment.
- (3) If the customer is in default of acceptance or if he negligently violates other

duties of cooperation, we shall be authorized to claim the damage incurred by us, including possible additional expenses. We reserve the right to additional claims.

(4) If the requirements stated in paragraph (3) are fulfilled, the risk of accidental loss or deterioration of the delivery items shall pass to the customer at the point in time at which the customer falls into default of acceptance or debtor's delay.

(5) According to the requirements of law, we are liable to the extent that the underlying purchase agreement is a firm deal in the sense of Section 286 Paragraph 4 of the German Civil Code or Section 376 of the German Commercial Code. We shall also be liable in accordance with statutory provisions if, as a consequence of any delay in delivery for which we are responsible, the customer is entitled to assert the right that his interest in the continued fulfilment of the contract has ended.

(6) We shall furthermore be liable according to the statutory provisions, provided the delay in delivery is due to a willful or grossly negligent contractual infringement for which we are responsible; fault on the part of our representatives or subcontractors shall be attributable to us. Provided that the breach of supply agreement is not based upon an intentional breach of contract for which we are to blame, our liability to make good damages shall be limited to the foreseeable damages typical for this type of contract.

(7) We shall also be liable according to the statutory provisions if the delay in delivery for which we are responsible is due to the culpable infringement of a fundamental contractual obligation (obligation whose fulfillment makes the proper execution of the contract possible at first and on whose compliance the contractual partner may regularly trust); in this case, liability for damages is, however, limited to the foreseeable, typically occurring loss.

(8) Further statutory claims and rights on the part of the customer shall be reserved.

Section 5 Transfer of risk • Packaging costs

- (1) Unless indicated differently in the order confirmation, delivery shall be „ex works“.
- (2) Transport packing and all other packaging as covered by the German Packing Ordinance shall not be taken back; pallets shall be excluded. The customer shall have a duty to take care of disposal of packing at his own expense. Note that the option of disposal free of charge exists due to the disposal partnership with INTERSEROH GmbH (contract no. 25608).
- (3) Provided it is in agreement with the customer, we shall insure the delivery with cargo insurance, the costs of which shall be paid by the customer.

Section 6 Responsibility for defects

(1) Any claims for defects raised by the customer presuppose that he has properly fulfilled his duties to investigate and to raise a complaint set forth in Section 377 of the German Commercial Code. To the extent that the purchased items are defective, the customer can, according to his own choice, require subsequent performance in the form of removal of the defect or in the form of delivery of a new non-defective product. In the event that the defect is remedied, we shall be obliged to bear all the necessary costs for the remedying of the defect, in particular transport, labour and material costs, provided that

(2) If the subsequent fulfilment fails, the customer may, depending on their choice, either decrease the remuneration or withdraw from the contract.

(3) We shall be liable in accordance with the relevant statutory regulations, insofar as the customer asserts claims for damages arising from intent or gross negligence, including intent or gross negligence on the part of our representatives or subcontractors. Provided that we are not accused of willful breach of contract, our liability for damages shall be restricted to foreseeable, typically occurring damages.

(4) We shall be liable in accordance with the relevant statutory regulations, insofar as we culpably violate a major contractual obligation; in this case, however, the liability for damages is likewise limited to the predictable, typically occurring damages.

(5) Liability for culpable harm to life, the human body, or health remains unaffected; this applies also to the liability mandated under the German Product

Liability Law.

(6) In the absence of any provisions to the contrary above, liability shall be excluded.

(7) Liability shall furthermore be excluded in the case of non-observance of the installation and processing instructions in the product catalogs

(8) Furthermore, we accept no liability for the durability of the adhesion of powder coatings on stainless steel profiles. The smooth and dense surface of stainless steel can cause the powder coating to peel off. Liability for such cases is expressly excluded. The relevant information for the respective profiles in the product catalog and on the product data sheet must be observed.

(9) The guarantee period for defect claims is 12 months from the date of the transfer of risk unless the product information indicates a longer guarantee period.

(10) The limitation period in case of delivery regress according to Sections 478, 479, of the German Civil Code shall remain unaffected; it shall be five years from delivery of the defective item.

Section 7 Joint liability

(1) Liability for damages extending beyond Section 6 shall be excluded without consideration of the legal nature of the asserted claim. This shall apply in particular to compensation claims for damages based on fault when entering into the contract, on account of other breaches of duty or on account of tortious compensation claims for property damage in accordance with Section 823 on the German Civil Code.

(2) The limitation pursuant to para. (1) shall also apply insofar as the customer requires replacement of useless expenditures instead of a claim for compensation for the damage.

(2) To the extent that liability for damages against us is excluded or restricted, this shall also apply in regard to the personal liability of our employees, salaried workers, associates, representatives and subcontractors.

Section 8 Reserved ownership rights

(1) We reserve the title to the goods pending full settlement of all claims arising from business relationship with the customer. In the event of any breach of contract by the customer, in particular any delay in payment, we shall be entitled to take back the item of sale. The cancellation of a purchased item by us shall indicate withdrawal from the contract. The seizure of the item of sale by us shall also constitute a withdrawal from the contract. After return of the item of sale, we shall be entitled to its utilisation, the utilisation proceeds shall be set-off against the accounts payable of the customer - minus reasonable utilisation costs. An extended retention of title does not apply to deliveries against advance payment. In the case of seizures or any other intervention of third parties, the customer shall immediately notify us in writing, so that we may file a suit in accordance with Section 771 of the German Code of Civil Procedure. If the third party is not in the position to reimburse us for any court and out-of-court costs incurred for the legal proceedings pursuant to Section 771 of the German Code of Civil Procedure, the customer shall be liable for any loss incurred by us.

(2) The customer shall be entitled to resell the object sold in the ordinary course of business. In that event, the customer shall forthwith inform the third party about our reservation of title. The customer shall hereby surrender all claims to us in the amount of the recognised balance (including value-added tax) of our claims that he has accrued from the resale to his purchaser or third party. The customer shall remain authorised to collect this claim even after surrender. Our right to collect the claim ourselves shall remain unaffected by this. We shall, however, be obligated to not extract the claim as long as the customer fulfils his payment obligations from the revenues received, is not in default for payment and, in particular, no application for the initiation of insolvency proceedings has been submitted and payments have not been suspended. However, in such cases, we shall be entitled to demand that the customer notifies us of the assigned claims and the respective liable parties, provides us with all information necessary to collect the claim and submits to us all appropriate documents and notifies the liable parties (third parties) of the assignment.

(3) Any processing or restructuring of the goods by the customer shall always

be performed on our behalf. If the bought object is joined inseparably to other objects that do not belong to us, we shall acquire a share in the ownership of the new object in the proportion of the objective value of our bought object (total invoice amount including VAT) to the other connected objects at the time of the processing. Apart from the above, the same shall apply to the item arising due to processing as to the item of sale delivered with reservation.

(4) If the object is inseparably mixed with other objects which do not belong to us, we acquire the co-ownership of the new item in proportion to the value of the item purchased (invoice amount including VAT) to the other mixed items at the time of the mixing. If the mixing is carried out in such a way that the customer's item is to be regarded as the main item, then it is agreed that the customer shall transfer us proportionately co-ownership. The customer shall store the resulting sole proprietorship or co-ownership for us.

(5) The customer also assigns to us the claims against a third party (arising from the combination of the object with a property in order to collateralize our claims against him).

(6) We oblige to release the collateral due to us upon request of the customer to such an extent as the feasible value of our collateral exceeds the claims to be secured by more than 20 %; the selection of the collateral to be released is incumbent upon us.

Section 9 Prohibition of assignment

Claims shall not be passed from the customer to us.

Section 10 Deposits, Cancellation, and Cancellation Costs

(1) We reserve the right to request a deposit for individual orders. The amount of the deposit will be stated in the order confirmation.

(2) Should the Buyer wish to cancel a contract, the Buyer must send a cancellation request to us in writing or in text form. We are entitled, but not obliged, to accept a cancellation request from the Buyer within a period of 10 days following receipt of the cancellation request.

(3) If we accept the cancellation, the Buyer is obliged to pay the following cancellation costs, which shall be offset against any deposit paid:

In the event of a cancellation request within 30 days before the agreed delivery date, 100% of the paid deposit or 20% of the order value; in the event of a cancellation request more than 30 days before the agreed delivery date, 50% of paid deposit or 10% of the order value. The date of receipt by us of the respective cancellation request is binding for the calculation.

Section 11 Jurisdiction - Place of fulfilment

(1) Insofar as the supplier is a merchant, the place of jurisdiction shall be our place of business; we shall, however, be entitled to bring proceedings against the supplier before the court of his place of business.

(2) The law of the Federal Republic of Germany shall apply; the provisions of UN commercial law shall be excluded.

(3) Unless otherwise stated in the order confirmation, the place of performance shall be our place of business.

Section 12 Other

These General sales terms and conditions were prepared in German and in English. In case of interpretation or in case of a text collision, the German version shall prevail.

Our current AGB apply, to be found under www.protektor.com/AGB as well as our liability references to technical data and calculations, to be found under www.protektor.com/HAS.

We accept no liability for any printing errors or other changes. Subject to change. Previous catalogues are hereby rendered invalid.

PROTEKTORWERK Florenz Maisch GmbH & Co. KG

A large, empty lined area for writing, consisting of numerous horizontal lines. A large, faint watermark of the word "PROTEKTOR" is centered across the page, with a thick grey arch above and below it.



PARTNERS WITH COMPETENCE

GREAT BRITAIN

PROTEKTOR UK Limited
Protektor House
Frederick Road
Hoo Farm Industrial Estate,
Kidderminster, Worcestershire
England, DY11 7RA
Tel. +44 [0] 1562 515 200
Fax +44 [0] 1562 515 116
sales@protektor.co.uk
www.protektor.co.uk

WEMICO
Matthew Lane
Hoo Farm Industrial Estate
Worcester Road
Kidderminster, Worcester
England, DY11 7RA
Tel. +44 [0] 1562 820 123
Fax +44 [0] 1562 822 012
wemico@wemico.co.uk
www.wemico.com

FRANCE

PROTEKTOR SAS
ZAE des Portes de la Forêt
43 allée du Clos des Charmes
77090 Collégien
Tel. +33 [0] 1 60 33 25 20
Fax +33 [0] 1 60 33 06 56
info@protektor-fr.com
www.protektor.fr

SWITZERLAND

PROTEKTOR PROFIL GmbH
Riedthofstr. 184
8105 Regensdorf
Tel. +41 [0] 4484 314 14
Fax +41 [0] 4484 314 24
info@protektor.ch
www.protektor.ch

AUSTRIA

**PROTEKTOR
International GmbH**
Viktoriastraße 58
76571 Gaggenau
Tel. +49 [0] 7225 977 0
Fax +49 [0] 7225 977 111
info@protektor.de
www.protektor.de

SPAIN

PROTEKTOR PERFILES, S.L.
Sr. Daniel Fernández-Sosa
C/Sant Auguri, 5. Bloque B.
Despacho 5
43002 Tarragona
mobile: +34 [0] 6090 237 68
info-spain@protektor.com
www.protektor.com/es



Protektor
since 1903

PROTEKTORWERK Florenz Maisch GmbH & Co. KG

Viktoriastraße 58
76571 Gaggenau

Postfach 1420
76554 Gaggenau

Tel. 07225 / 9 77-0
Fax 07225 / 9 77-111

info@protektor.com
www.protektor.com